

# Feel the water

GENEBRE

Colección Grifería Cocina y Baño  
Tap Collection Kitchen & Bathroom  
2024—2025



# GENEBRE

**Tenemos una visión común que es el faro que guía nuestro rumbo: cuidar del agua, el recurso natural más valioso y esencial para la vida. Lo hacemos con las soluciones que aportamos hoy en día y también con las que descubriremos en el futuro.**

*We have a common vision which is our guiding light: taking care of water, the most valuable and essential natural resource for life. We do this with the solutions we provide today and also with those we will discover in the future.*

**¿Deseas más información?**

*Do you want more information?*



**[www.genebre.es](http://www.genebre.es)**

**Síguenos / Follow us:**







**Contacta con nosotros:**

*Contact us:*

---

**GENEBRE GROUP**

Edificio Genebre  
Avda. Joan Carles I, 46-48  
Distrito económico de l'Hospitalet  
08908 l'Hospitalet de Llobregat  
Barcelona (SPAIN)  
Teléfono / Phone +34 93 298 80 00  
**www.genebre.es**

---

**CONTACTO COMERCIAL**

*COMMERCIAL CONTACT*

**España / Spain**

Teléfono / Phone +34 93 298 80 01  
Fax: + 34 93 298 80 06  
griferia@genebre.es

**Europa / Europe**

Teléfono / Phone +34 93 298 80 15

**Europa este / East Europe**

Teléfono / Phone +34 93 298 80 19

**América latina / Latin America**

Teléfono / Phone +34 93 298 80 17

**América del norte / North America**

Teléfono / Phone +34 93 298 80 00  
Fax: + 34 93 298 80 08

**www.genebre.com**

**exportacion@genebre.es**

---

**OTROS TELÉFONOS**

*OTHER TELEPHONE NUMBERS*

**Centralita / Central telephone number**

Teléfono / Phone +34 93 298 80 00

**Administración / Administration**

Teléfono / Phone +34 93 298 80 02  
Fax: + 34 93 298 80 07

**Servicio de atención técnica al cliente /  
Technical support**

Teléfono / Phone +34 902 504 203

---

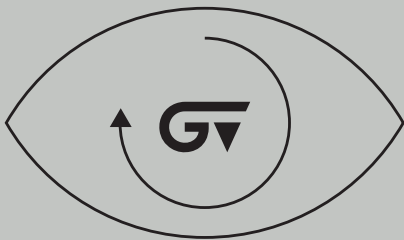

## Cuidamos del agua desde el origen hasta el retorno al medio a través de una amplia gama de productos para cada fase

We take care of water from origin to return to source through a wide range of products for each phase

**En Genebre Group completamos el ciclo del agua pensando en las personas y el planeta. Porque cuando llega a nuestros hogares, espacios públicos o privados, aplicamos soluciones para optimizar y ahorrar tanto agua como energía. Siempre pensando en conseguir máxima eficiencia, calidad y confort.**

*At Genebre Group, we complete the water cycle with people and the planet in mind. Because when it reaches our homes, public or private spaces, we apply solutions to optimize and save both water and energy. Always thinking about achieving maximum efficiency, quality and comfort.*

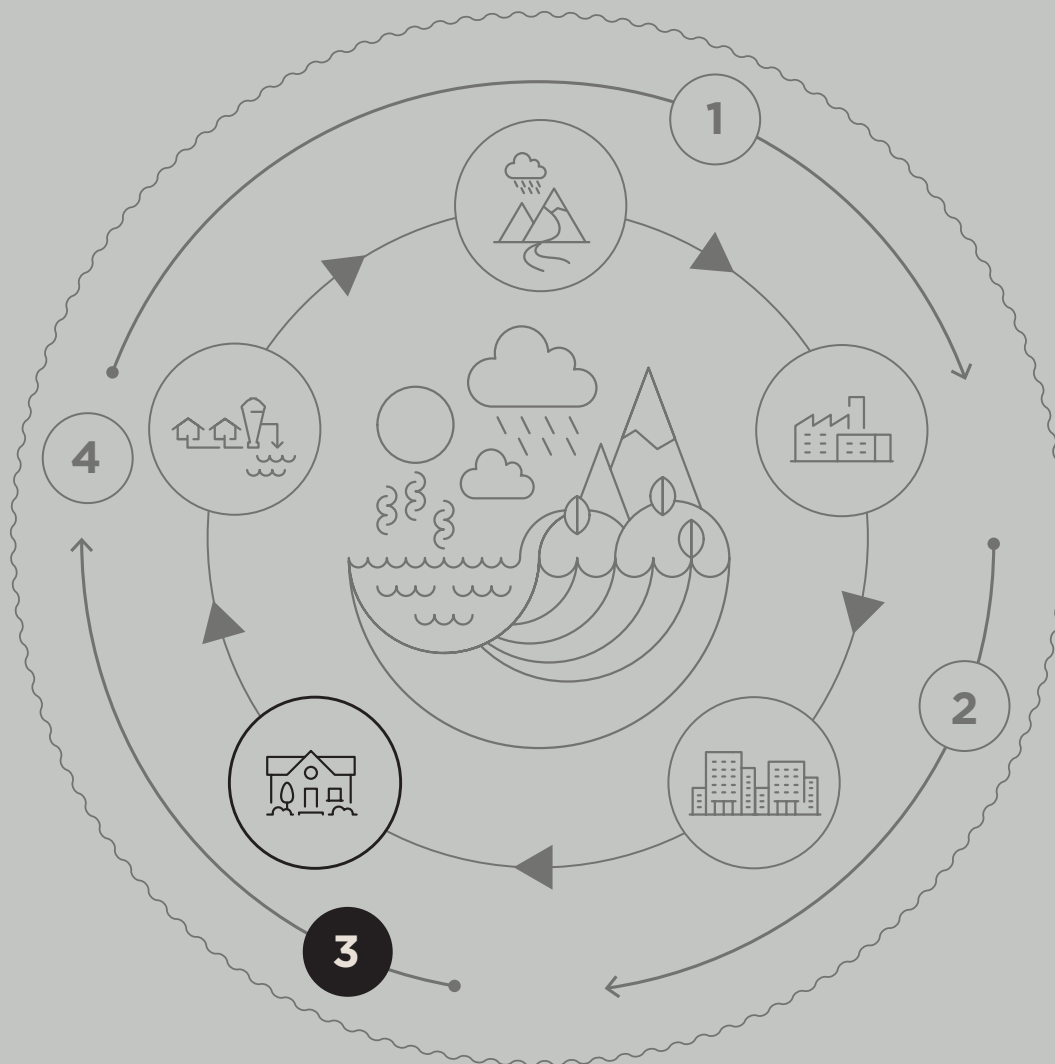

## BIENESTAR, DISEÑO Y OPTIMIZACIÓN.

Máxima funcionalidad, espíritu sostenible.  
Diseñamos sistemas, soluciones y diversidad de productos que promueven el bienestar de las personas desde la eficiencia y la optimización tanto del agua como de la energía.

## WELL-BEING, DESIGN AND OPTIMIZATION.

Maximum functionality, sustainable spirit.  
We design systems, solutions and product diversity that promote people's well-being based on efficiency and optimization of both water and energy.



# Cerca de ti en cualquier momento

Close to you at any time

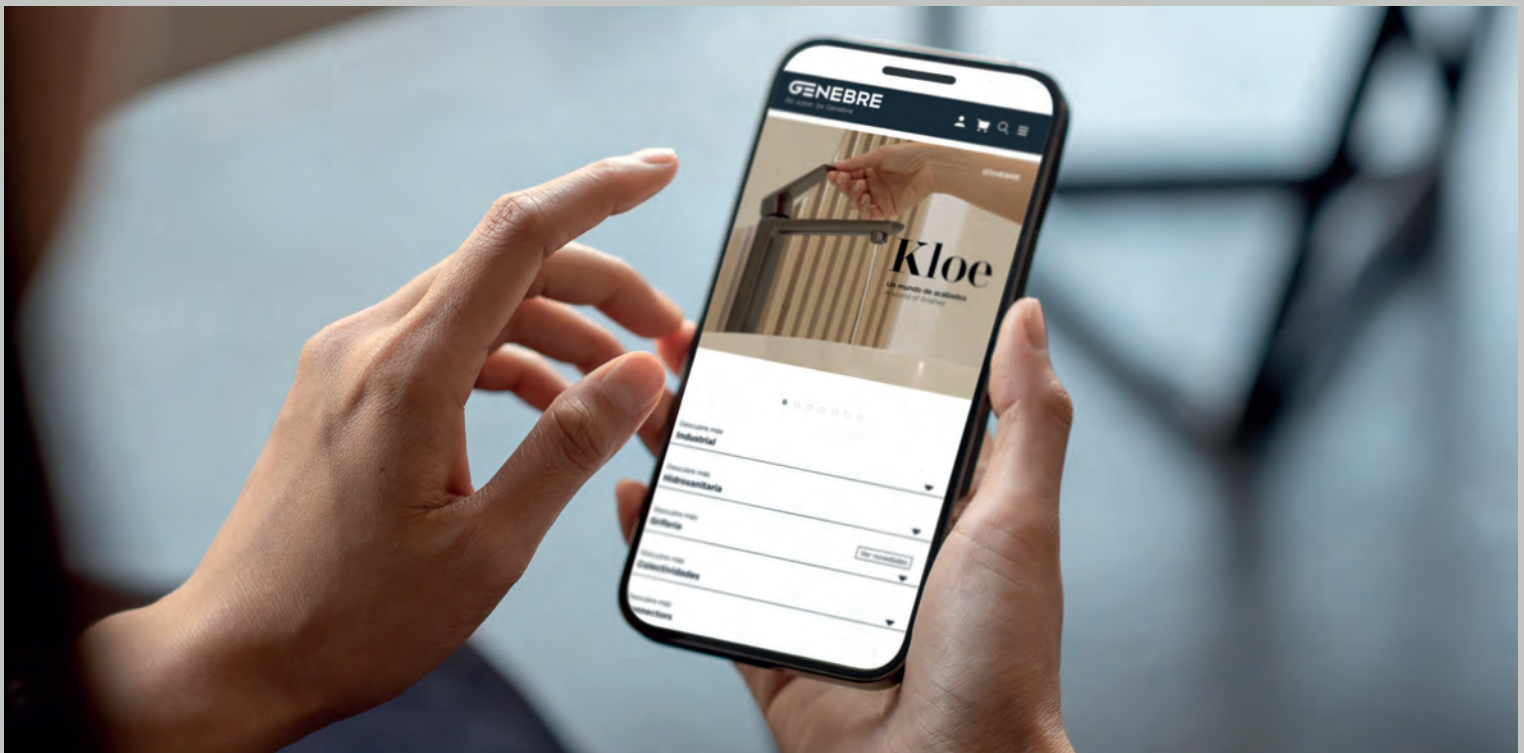

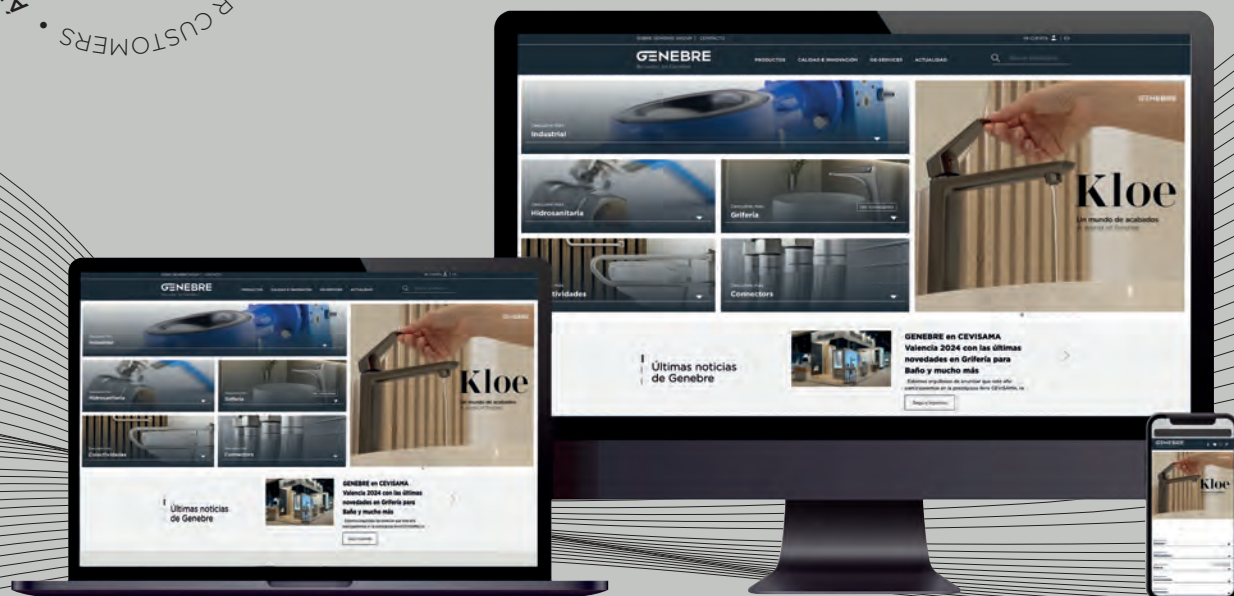

## ¿Conoces todas las ventajas de nuestra página web?

En Genebre trabajamos día a día para seguir mejorando todos nuestros canales de comunicación contigo. Especialmente a través de nuestra web. Por eso, ya seas profesional, instalador, colaborador, usuario o cliente, en nuestro site encontrarás toda la información que necesites. Las 24 horas del día, los 365 días del año. Por ejemplo:

- > Descubre nuestras últimas novedades
- > Información de nuestros productos
- > Consulta Fichas técnicas
- > Descarga Manuales e Instrucciones
- > Accede al Área de descargas y últimas noticias
- > Además, si eres cliente activo Genebre podrás beneficiarte del Área Exclusiva para clientes.



¿Eres cliente de Genebre?  
Solicita el alta aquí

## Do you know all the advantages of our website?

At Genebre we work every day to continue improving all our communication channels with you. Especially through our website. Therefore, whether you are a professional, installer, collaborator, user or client, on our site you will find all the information you need. 24 hours a day, 365 days a year.

For example:

- > Discover our latest news
- > Information about our products
- > Consult technical specifications
- > Download Manuals and Instructions
- > Access the downloads and latest news area
- > Additionally, if you are an active Genebre customer you can benefit from the Exclusive Area for customers.



Are you a Genebre customer?  
Request registration here

**GENEBRE**

# Índice

Index

---

**Cuidamos del agua**  
We take care of water **p. 02**

---

**Cerca de ti**  
Close to you **p. 04**

---

**Feel the Water** **p. 08**

---

**Feel the Quality** **p. 10**

---

**Más opciones ecológicas**  
More green options **p. 12**

---

**Tecnología**  
Technology **p. 14**

---

**Novedades 2024**  
News 2024 **p. 16**

---

**Acabados**  
Finishes **p. 18**

---

**Medidas**  
Measures **p. 20**

---

**Grifería para Baños**  
Bathroom taps **p. 22**

---

Kloe	24
Koral	32
Oslo	42
Kode	54
Klip	62
Tau	68
Tau 2	78
Kenjo	84
K8	92
Ge2	98
New Regent Classic	106
New Regent	112
Gamma	118
Ixo	124
Kross	128
Kalo	132
Style shower	136
GEBOX system	148

---



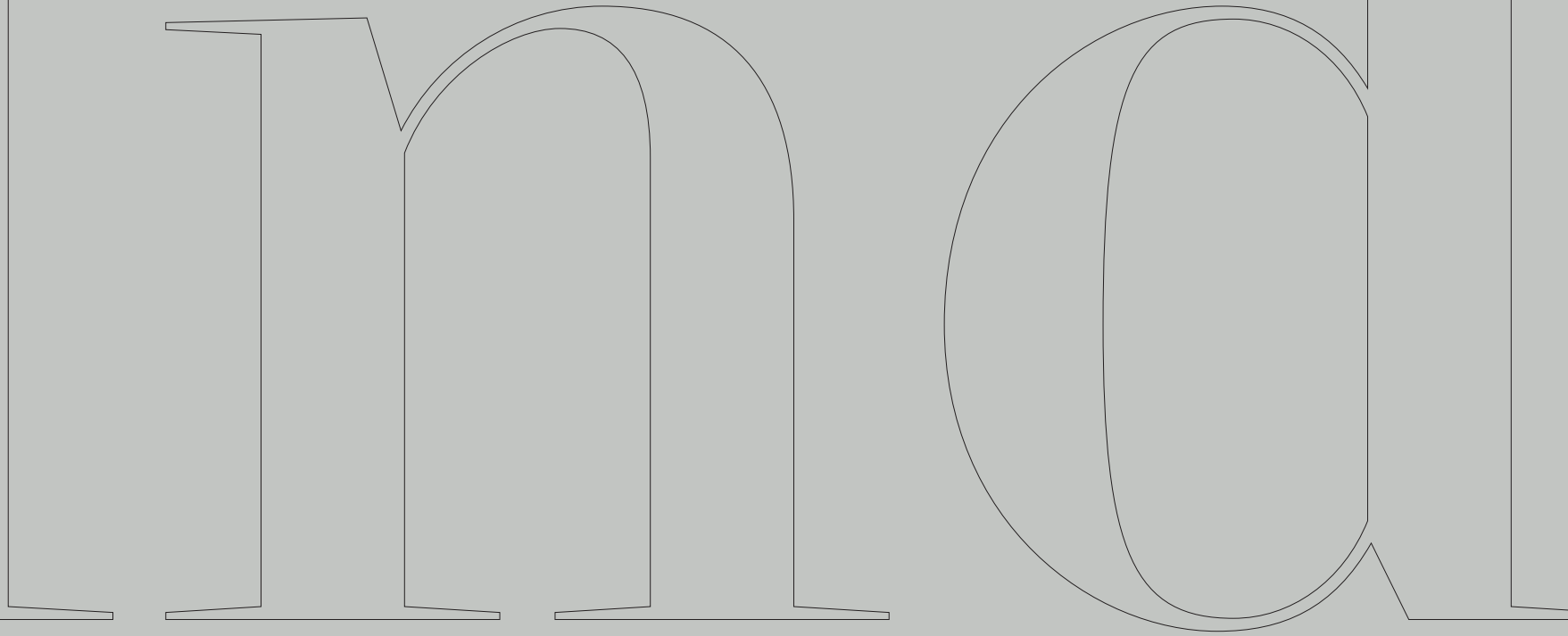

## Grifería para Cocinas

### Kitchen taps

p. 150

#### Grifería de cocina para encimeras

Countertop sink mixers

152

#### Grifería de cocina para filtrado

Sink mixers for filtration

158

#### Grifería de cocina extraíbles

Pull out sink mixers

160

#### Grifería de cocina con muelle

Sink mixers with spring

164

#### Grifería de cocina mural

Wall-mounted sink mixers

166

#### Grifería de cocina abatible

Folding sink mixers

168

#### Grifería de cocina selección inox

Stainless steel selection sink mixers

169

#### Grifería de cocina Classic

Classic sink mixers

172

#### Grifería de cocina de 1 agua

One-water sink taps

182

### Accesorios

Accessories

p.184

### Packaging

p.206

### Punto de venta

Point of sale

p.207

### Recambios

Spare parts

p.208

### Información técnica

Technical information

p.226

### Índice por referencia

Index by reference

p.292

### Condiciones de venta

Sales conditions

p.298

# Feel the water







El agua es vida. Sólo con verla y oírla, aumenta el flujo sanguíneo en el cerebro y el corazón, y nos relaja.

En Genebre sabemos la gran variedad de beneficios que sólo el agua puede ofrecer. Por eso seguimos mejorando continuamente nuestros productos para que tu experiencia con el agua sea cada día mejor. Esa es nuestra razón de ser y lo que en realidad mejor sabemos hacer.

*Water is life. Just seeing and hearing it increases the blood flow in the brain and heart, and relaxes us.*

*At Genebre, we know the great variety of benefits that only water can offer. That's why we continue improving our products so that your experience with water is better every day. That is our reason for being and what we really know best how to do.*



# GENEBRE

## Feel the quality



En Genebre podríamos hablarte de los rigurosos exámenes que organismos de certificación independientes han realizado a todos nuestros productos (laboratorios ENAC, laboratorio Oliver Rodés, WRAS, ACS).

También podríamos aburrirte enumerando las complejas normativas que cumple nuestra empresa (la ISO 9001, la ISO 14001) o nuestros productos ( la UNE-EN 19703, la EN 1982, la CW617N, la EN 12165, la ISO 9227, la EN 200, la NF 077, la EN1717, ...).

O maravillarte con las numerosas pruebas de resistencia a las que sometemos a nuestros productos antes de que salgan al mercado (discos cerámicos capaces de resistir más de 200.000 maniobras, giro de los caños que después de más de 80.000 accionados siguen como el primer día, cromados resistentes a la corrosión, plásticos anticálcareos, el latón y sus aleaciones, etc...).

Pero por encima de todo, queremos hablarte de nuestro compromiso con la calidad y la salud, del ahorro de agua y energía o de la garantía y la asistencia técnica con la que nos encontrarás siempre a tu lado.

Homologación CE (cuando es requerido) y otras específicas para mercados como Bielorrusia, Chile, Polonia, Rusia, México, Ucrania, Singapur y Arabia Saudí.

GENEBRE es miembro de Agrival, Asociación nacional de fabricantes de grifería y valvulería.

*At Genebre we could tell you about the rigorous examinations that independent certification institutions have carried out on our products (ENAC laboratories, Oliver Rodés laboratory, WRAS, ACS).*

*We could also bore you just by listing the large list of regulations that our company complies with (ISO 9001, ISO 14001) or our products (UNE-EN 19703, EN 1982, CW617N, EN 12165, ISO 9227, EN 200, NF 077, EN1717, ...).*

*Or marvel you with the numerous resistance tests that we always undergo internally to our products before they are launched on the market (ceramic discs capable of withstanding more than 200,000 maneuvers, turning of the pipes that after more than 80,000 actuation continue as the first day, corrosion-resistant chrome plating, anti-limescale plastics, brass and its alloys, etc ...*

*But above all, we want to talk to you about our commitment to quality and health, saving water and energy or the guarantee and technical assistance with which you will always find us by your side.*

*EC homologation (when required) and other specific certifications for markets in Belarus, Chile, Poland, Russia, Mexico, Ukraine, Singapore and Saudi Arabia.*

*GENEBRE is a member of Agrival, the national association of taps and valve manufacturers.*

### Grifería diseñada para edificios sostenibles

En GENE BRE desarrollamos productos pensados para mejorar el nivel de sostenibilidad de edificios y el confort de las personas, para que arquitectos, ingenieros y, en general, cualquier profesional de la construcción, puedan desarrollar sus proyectos de edificios sostenibles, saludables, respetuosos con el medio ambiente y que cumplan con la normativa vigente.

### Taps designed for sustainable buildings

*At GENE BRE we develop products that improve the level of sustainability of buildings and the comfort of people, so that architects, engineers and, in general, any construction professional, can develop their projects of sustainable, healthy, environmentally friendly buildings and that comply with current regulations.*





## La grifería GENE BRE ayuda a cumplir y mejorar las certificaciones: *GENE BRE taps help to comply and improve the certifications:*

**Certificación LEED (America) para la eficiencia con el consumo de agua, limitando el consumo máximo de litros por minuto o de litros por uso en el caso de temporizados.**



*LEED certification (America) for efficiency with water consumption, limiting the maximum consumption of liters per minute or liters per use in the case of timer.*

**Certificación DGNB (Alemania) para la evaluación y certificación de la sostenibilidad, que contempla aspectos medioambientales, económicos y socio-culturales de los edificios.**



*DGNB certification (Germany) for the evaluation and certification of sustainability, which considers environmental, economic and socio-cultural aspects of buildings.*

**Certificación BREEAM (Inglaterra) para la evaluación y certificación de la sostenibilidad en la edificación que actualmente ya cuenta con 600.000 edificios certificados en más de 90 países.**



*BREEAM certification (England) for the evaluation and certification of sustainability in buildings, which currently has 600,000 certified buildings in more than 90 countries.*

**La Certificación Edificio Sustentable (CES, Chile) para incentivar el diseño y la construcción de edificios con criterios de sustentabilidad y estimular el mercado para que valore este tipo de edificaciones.**



*The Sustainable Building Certification (CES, Chile) to encourage the design and construction of buildings with sustainability criteria and stimulate the market to value this type of buildings.*

**Certificación WELL sistema de puntuación dinámico para edificios y comunidades que permite identificar, medir y monitorizar las características de los espacios construidos que impactan en la salud y el bienestar de los ocupantes.**



*WELL certification, a dynamic scoring system for buildings and communities that allows to identify, measure and monitor the characteristics of the built spaces that impact on the health and well-being of the occupants*

**Certificación de Sustentabilidad (CS, Argentina) para dar visibilidad a las acciones relacionadas con el cuidado del Medio Ambiente y la Responsabilidad Social Empresarial.**



*Sustainability Certification (CS, Argentina) to give visibility to actions related to caring for the Environment and Corporate Social Responsibility.*

**Certificación Verde España: sistema de evaluación y certificación de la sostenibilidad. Un evaluador acreditado realiza la evaluación con la herramienta VERDE como paso previo a la certificación del edificio.**



*Green Spain Certification: sustainability evaluation and certification system. An accredited evaluator performs the evaluation with the GREEN tool as a preliminary step to the certification of the building.*

**Porque un edificio sostenible es el que funciona bien hoy y en el futuro.**

*Because a sustainable building is one that works well today and in the future.*

**Si tienes dudas o consultas, ponte en contacto con nuestro Departamento de Proyectos donde analizaremos tu caso en concreto y te ofreceremos un asesoramiento personalizado.**

*If you have questions or queries, get in touch with our Projects Department where we will analyze your specific case and offer you personalized advice.*





# Más opciones ecológicas

## More green options

Presentamos los sistemas que incorporan las diferentes griferías de GENE BRE para ahorrar en el gasto de agua y energía. Novedades diseñadas especialmente para facilitar el uso y, a su vez, hacerlo más seguro y medioambientalmente sostenible.

### **Promoviendo la sensibilidad y el respeto por el medioambiente**

GENEBRE es una compañía comprometida con el medioambiente. Su visión de un futuro sostenible y una filosofía enfocada en proteger el agua y los fluidos le permiten mejorar, investigar, desarrollar y crear conceptos innovadores a partir de las tecnologías más punteras. De manera que aplica siempre criterios que transmitan valores ecológicos en todos sus productos y a la vez que satisfagan las necesidades de funcionalidad, confort y diseño de los usuarios.

GENEBRE ha colaborado en el programa de I+D NUESVAL. Un estudio coordinado por el Centro Tecnológico de Manresa cuyo objetivo es desarrollar nuevas aleaciones de latón para válvulas de conducción de fluidos en condiciones ambientales de alta temperatura. Un modelo de proyecto basado en la innovación, en el que GENE BRE ha depositado su compromiso empresarial, con el fin de desarrollar tipos específicos de válvulas destinadas tanto a instalaciones domésticas como industriales..

*The following user-friendly systems include the different GENE BRE taps that make for safer and more environmentally sustainable use, leading to financial savings in water expenditure and/or domestic energy.*

### **Promoting respect for the environment**

*GENEBRE is a company committed to the environment. Its vision of a sustainable future and a philosophy focused on protecting water and fluids allow it to improve, research, develop and create innovative concepts using the most advanced technologies. GENE BRE always applies the same criteria which transmits ecological values in all of its products, and at the same time satisfies the users' needs of functionality, comfort, and design.*

*GENEBRE has collaborated el programa de I+D NUESVAL, a study coordinated by the Centro Tecnológico de Manresa, whose objective is to develop new brass and bronze alloy for valves. It is a project model based on innovation, in which GENE BRE reinforces its commitment to developing specific types of valves for domestic as well as industrial installations.*



**Ahorro de agua** *Water saving*  
**Ahorro energético** *Energy saving*  
**Medio ambiente** *Environment*  
**Sostenibilidad** *Sustainability*



**Sistema GE-ECO.**  
 En las series Koral, Kode,  
 Klip, Tau y Oslo.

*GE-ECO system.*  
*In Koral, Kode, Klip, Tau*  
*and Oslo series.*



**Sistema GE-COLD START.**  
 En las series Tau y Oslo.

*GE-COLD START.*  
*In Tau y Oslo series.*

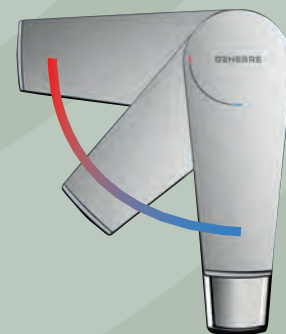

**Gran variedad de economizadores.**

*A wide range of economizers.*



**Sistemas de filtrado.**  
 En las serie Tau Cocinas.

*Filtration systems.*  
*In Tau Kitchen serie.*



**GENEBRE**

# Tecnología

## Technology

Presentamos los sistemas que incorporan las diferentes griferías de GENE BRE para ahorrar en el gasto de agua y energía.

Novedades diseñadas especialmente para facilitar el uso y, a su vez, hacerlo más seguro y medioambientalmente sostenible.

*The following user-friendly systems include the different GENE BRE taps that make for safer and more environmentally sustainable use, leading to financial savings in water expenditure and/or domestic energy.*



**GE-ECO**

- **Economizador de agua.**
- **Ahorro de energía.**
- *Water economizer.*
- *Energy saving.*



**GE-2P**

### **Apertura del grifo en dos posiciones:**

- Primera posición: **ahorro del 50% de agua.**
- Segunda posición: pleno caudal.

### **Two-position opening of the tap:**

- First position: **supplies 50% less water.**
- Second position: full flow.



# Innovo



## GE-COLD START

- **Gran ahorro energético:**

Descubre todos los nuevos productos con tecnología GE-COLD START, podrás identificarlo con el icono superior en cada producto.

- **Great deal of energy:**

*prevents boiler, heater or electric boiler from being activated unduly.*



Ref. 65219 18 45 66



## GE-SAFE

- **Prevención ante quemaduras:**

limita a 38°C el caudal de agua caliente, y asegura el corte de agua para evitar quemaduras en caso de fallo del suministro de agua fría.

- **Prevention against burns:**

*limits and ensures hot water cuts off at a maximum temperature of 38°C, avoiding burns in the event of a cut in the cold-water supply.*

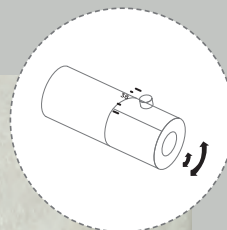

Ref.: 67112 14 45 67

# Novedades

## News

### 2024

NEW

- 1 Nueva Serie Kloe versátil y estilizada, disponible con los nuevos acabados Brushed Metal y Gold.
- 2 Nuevos acabados Black en serie Koral.
- 3 Nuevos accesorios para baño en los nuevos acabados Brushed Metal y Gold.
- 4 Nueva grifería empotrada para ducha GEBOX con sistema premontado
- 5 Nuevos accesorios para mayor modularidad en grifería empotrada para ducha.
- 6 Nueva sección de Ayudas Técnicas a la Instalación.

- 1 *New versatile and stylish Kloe Series, available with the new Brushed Metal and Gold finishes.*
- 2 *New Black finishes in series such as Koral.*
- 3 *New bathroom accessories in the new Brushed Metal and Gold finishes.*
- 4 *New GEBOX built-in shower taps with pre-assembled system*
- 5 *New accessories for greater modularity in built-in shower taps.*
- 6 *New section of Technical Installation Aids.*





Brushed  
Gold



Black



1 3

Nueva Serie de grifería  
para Baño KLOE y nuevos  
acabados en accesorios

*New Bathroom Taps KLOE  
Series and new finishes  
in accessories*

Chrome



Brushed  
Metal



## Nueva estructura New structure

Nueva presentación de acabados de  
producto, agrupados por referencias.  
Además, podrás acceder a la  
información técnica a través del QR.

*New presentation of product finishes,  
grouped by references. In addition,  
you can access technical information  
through the QR.*

Acabados Finishes

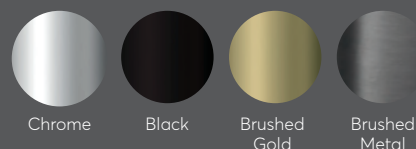

Chrome

Black

Brushed  
Gold

Brushed  
Metal



### Monomando de ducha empotrado

Built-in single lever shower mixer

● Ref.: 69115 34 45 66 - **Chrome**

● Ref.: 69115 34 41 66 - **Black**

● Ref.: 69115 34 51 66 - **Brushed Gold**

● Ref.: 69115 34 52 66 - **Brushed Metal**



Consulta las especificaciones técnicas  
de los productos escaneando el QR  
Check the technical specifications  
of the products by scanning the QR



GENEBRE

# Acabados

Finishes



# Amisino



Chrome



Black



Brushed Gold

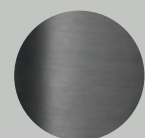

Brushed Metal



Bronze



White



Inox

**GENEBRE**

# Medidas

## Measures

Porque cada baño es distinto y personal, en Genebre ponemos a tu disposición diferentes alturas en todos nuestros grifos de las colecciones Kode, Oslo, Tau, Tau2, Koral, Klip, Klip2, Kelogic, Kenjo y K8, fabricadas siempre de una sola pieza, aportando un plus de diseño y robustez.

Tú eliges. La altura convencional de toda la vida para lavarse las manos, o una altura media, alta, empotrada o de pie con los que también podrás llenar recipientes, lavarte el pelo o darle a tu baño ese toque de diseño que estabas buscando.

*Because each bathroom is different and personal, at Genebre we offer you different heights in all our taps from the Kode, Oslo, Tau, Tau2, Koral, Klip, Klip2, Kelogic, Kenjo and K8 collections, all of them manufactured in one piece providing a plus of design and robustness.*

*It's your choice. The conventional height to wash your hands, or a medium, high, recessed or standing height with which you can also fill containers, wash your hair or give your bathroom that touch of design that you were looking for.*

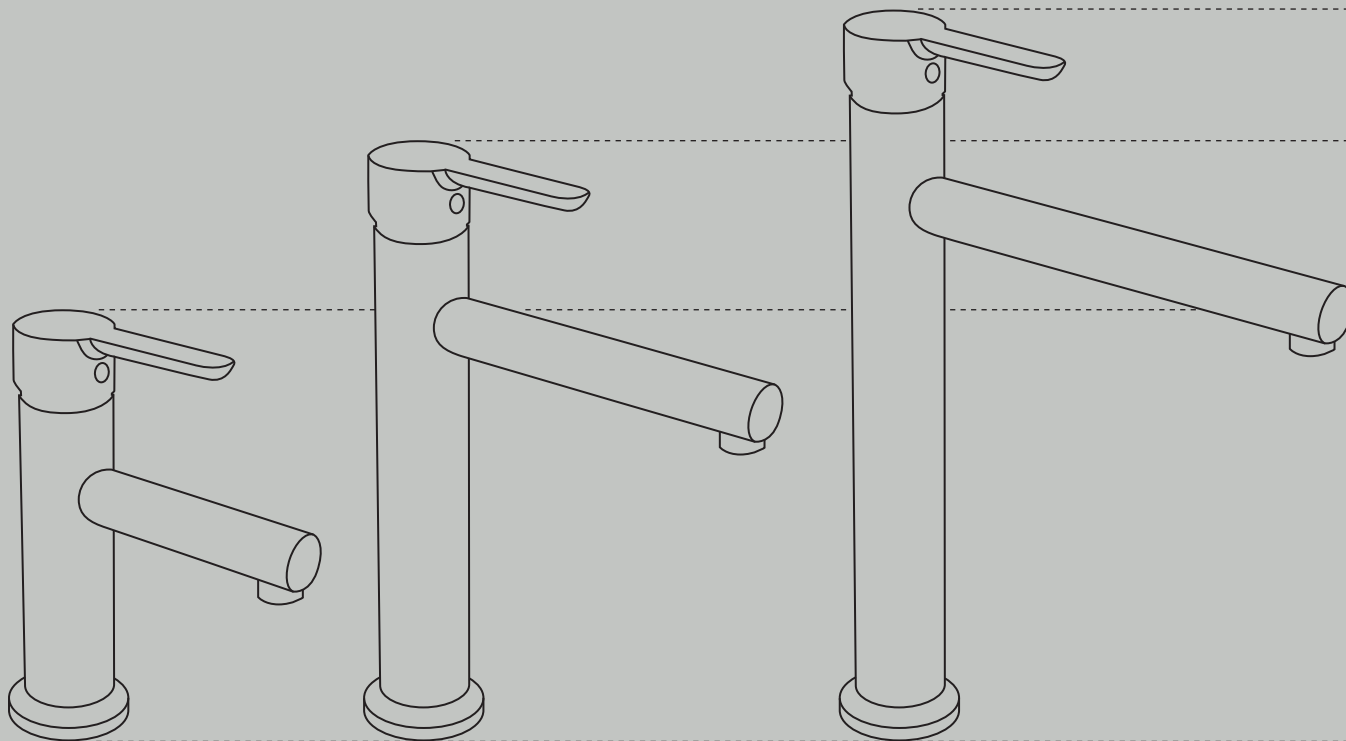



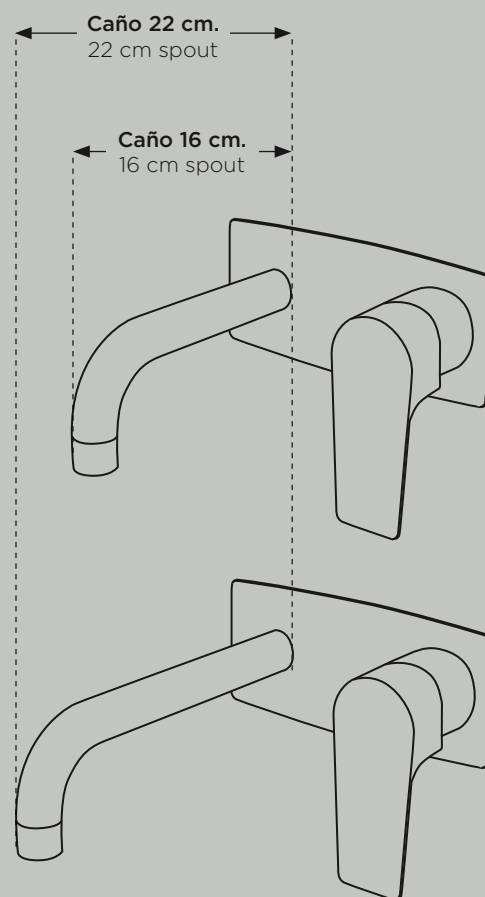
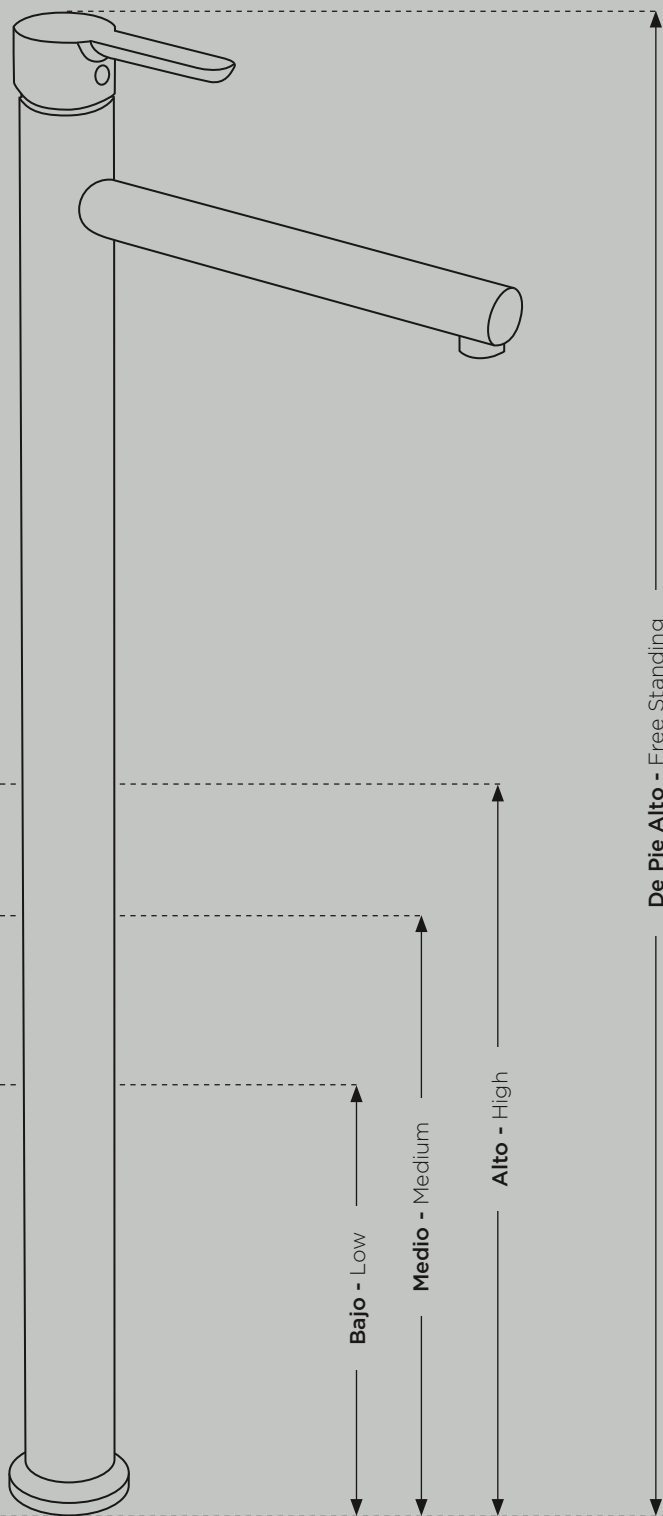

**Genebre: soluciones a medida y máximo confort para cada lavabo, ya sea empotrado, sobre encimera, normal o tipo bol.**

*Genebre: tailor-made solutions and maximum comfort for each washbasin, whether built-in, countertop, normal or bowl-type.*

DB

# Baños

## Bathrooms

**El agua es vida. Sólo con verla y oírla, aumenta el flujo sanguíneo en el cerebro y el corazón, y nos relaja.**

**En Genebre sabemos la gran variedad de beneficios que sólo el agua puede ofrecer. Por eso seguimos mejorando continuamente nuestros productos para que tu experiencia con el agua sea cada día mejor. Esa es nuestra razón de ser y lo que en realidad mejor sabemos hacer.**

*Water is life. Just seeing and hearing it increases the blood flow in the brain and heart, and relaxes us.*

*At Genebre, we know the great variety of benefits that only water can offer. That's why we continue improving our products so that your experience with water is better every day. That is our reason for being and what we really know best how to do.*





# Kloe

## Un mundo de acabados / A world of finishes

**La nueva serie Kloe reafirma el concepto de estilo y elegancia, con un diseño único, puro y estilizado. Además, se adapta perfectamente a todo tipo de espacios de baño, gracias a su incomparable versatilidad y una amplia gama de acabados.**

The new Kloe series reaffirms the concept of style and elegance, with a pure and stylized design. In addition, it adapts perfectly to all types of bathroom spaces, thanks to its incomparable versatility and a wide range of finishes.

**Monomandos Lavabo**  
Single lever wash-basin mixers





# Kloe



Consulta las especificaciones técnicas de los productos escaneando el QR  
Check the technical specifications of the products by scanning the QR



## Acabados Finishes



Chrome

Black

Brushed  
GoldBrushed  
Metal

### Monomando de lavabo

Single lever  
wash-basin mixer

- Ref.: 69130 34 45 66 - **Chrome**
- Ref.: 69130 34 41 66 - **Black**
- Ref.: 69130 34 51 66 - **Brushed Gold**
- Ref.: 69130 34 52 66 - **Brushed Metal**



### Monomando de lavabo medio alto

Medium height single lever  
wash-basin mixer

- Ref.: 69134 34 45 66 - **Chrome**
- Ref.: 69134 34 41 66 - **Black**
- Ref.: 69134 34 51 66 - **Brushed Gold**
- Ref.: 69134 34 52 66 - **Brushed Metal**



### Monomando de lavabo alto

High single lever  
wash-basin mixer

- Ref.: 69136 34 45 66 - **Chrome**
- Ref.: 69136 34 41 66 - **Black**
- Ref.: 69136 34 51 66 - **Brushed Gold**
- Ref.: 69136 34 52 66 - **Brushed Metal**



¡Enlaza al video y déjate inspirar con nuestra nueva serie Kloe para baños!

Link to the video and be inspired by our new Kloe series for bathrooms!

Acabados *Finishes*



Chrome



Black



Brushed  
Gold

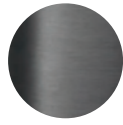

Brushed  
Metal



**Monomando de lavabo empotrado caño 16 cm**

Built-in wash-basin mixer 16 cm spout

- Ref.: 69131 34 45 66 - **Chrome**
- Ref.: 69131 34 41 66 - **Black**
- Ref.: 69131 34 51 66 - **Brushed Gold**
- Ref.: 69131 34 52 66 - **Brushed Metal**



**Monomando de lavabo empotrado caño 22 cm**

Built-in wash-basin mixer 22 cm spout

- Ref.: 69132 34 45 66 - **Chrome**
- Ref.: 69132 34 41 66 - **Black**
- Ref.: 69132 34 51 66 - **Brushed Gold**
- Ref.: 69132 34 52 66 - **Brushed Metal**



**Monomando de bidé**

Single lever bidet mixer

- Ref.: 69140 34 45 66 - **Chrome**
- Ref.: 69140 34 41 66 - **Black**
- Ref.: 69140 34 51 66 - **Brushed Gold**
- Ref.: 69140 34 52 66 - **Brushed Metal**



**Monomando de bidé con transmisión**

Single lever bidet mixer with diverter

- Ref.: 69142 34 45 66 - **Chrome**
- Ref.: 69142 34 41 66 - **Black**
- Ref.: 69142 34 51 66 - **Brushed Gold**
- Ref.: 69142 34 52 66 - **Brushed Metal**





**Monomandos Empotrados para Lavabo**  
Built-in wash-basin mixers



# Monomandos Empotrados para Ducha

Single lever shower mixers



Ref.: 69115 34 51 66





Acabados *Finishes*



**Monomando de baño con kit**  
Single lever bath mixer with kit

- Ref.: 69100 34 45 66 - **Chrome**
- Ref.: 69100 34 41 66 - **Black**
- Ref.: 69100 34 51 66 - **Brushed Gold**
- Ref.: 69100 34 52 66 - **Brushed Metal**

**Monomando de ducha con kit**  
Single lever shower mixer with kit

- Ref.: 69110 34 45 66 - **Chrome**
- Ref.: 69110 34 41 66 - **Black**
- Ref.: 69110 34 51 66 - **Brushed Gold**
- Ref.: 69110 34 52 66 - **Brushed Metal**



**Monomando de ducha empotrado**  
Built-in single lever shower mixer

- Ref.: 69115 34 45 66 - **Chrome**
- Ref.: 69115 34 41 66 - **Black**
- Ref.: 69115 34 51 66 - **Brushed Gold**
- Ref.: 69115 34 52 66 - **Brushed Metal**

**Monomando empotrado con inversor 2 vías**  
2 way Built-in single lever mixer with diverter

- Ref.: 69116 34 45 66 - **Chrome**
- Ref.: 69116 34 41 66 - **Black**
- Ref.: 69116 34 51 66 - **Brushed Gold**
- Ref.: 69116 34 52 66 - **Brushed Metal**





# Koral

## Relájate / Relax

**Siente tu respiración. Deja que el agua acaricie todos tus poros, y disfruta de las sinuosas líneas y el estilo propio de la nueva Serie Koral.**

*Feel your breath. Let the water caress all your pores, and enjoy the sinuous lines of the new Koral Series.*

# Koral

Acabados Finishes

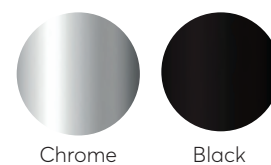

Chrome



Black

Consulta las especificaciones técnicas de los productos escaneando el QR  
Check the technical specifications of the products by scanning the QR



## Monomando de lavabo

Single lever wash-basin mixer

● Ref.: 64130 32 45 66 - **Chrome**

● Ref.: 64130 32 41 66 - **Black**



## Monomando de lavabo medio alto

Medium height single lever wash-basin mixer

● Ref.: 64134 32 45 66 - **Chrome**

● Ref.: 64134 32 41 66 - **Black**



## Monomando de lavabo alto

High single lever wash-basin mixer

● Ref.: 64136 32 45 66 - **Chrome**

● Ref.: 64136 32 41 66 - **Black**



## Monomando de lavabo apertura en frío

Single lever wash-basin mixer cold start

● Ref.: 64150 32 45 - **Chrome**



Monomandos de Lavabo  
Wash-basin mixers



Ref.: 64130 32 41 66



**Monomandos de Lavabo Empotrados**  
Built-in wash-basin Mixers





Acabados *Finishes*



Chrome

Black



**Monomando de lavabo empotrado caño 16 cm**  
Built-in wash-basin mixer 16 cm spout

- Ref.: 64131 32 45 66 - **Chrome**
- Ref.: 64131 32 41 66 - **Black**



**Monomando de lavabo empotrado caño 22 cm**  
Built-in wash-basin mixer 22 cm spout

- Ref.: 64132 32 45 66 - **Chrome**
- Ref.: 64132 32 41 66 - **Black**



**Monomando de bidé**  
Single lever bidet mixer

- Ref.: 64140 32 45 66 - **Chrome**
- Ref.: 64140 32 41 66 - **Black**



**Monomando de bidé con transmisión**  
Single lever bidet mixer with diverter

- Ref.: 64142 32 45 66 - **Chrome**
- Ref.: 64142 32 41 66 - **Black**



**Monomando de ducha con kit**  
Single lever shower mixer with kit

- Ref.: 64110 32 45 66 - **Chrome**
- Ref.: 64110 32 41 66 - **Black**



**Monomando de baño con kit**  
Single lever bath mixer with kit

- Ref.: 64100 32 45 66 - **Chrome**
- Ref.: 64100 32 41 66 - **Black**



\* **Kit incluido**

\* **Kit included**



Se crean 5 variantes de monomando para bañera exenta, y un juego de columnas equipables con la grifería a escoger. Todas las variantes poseen un sistema de regulación único, el cuál nos ayudará a instalarlo totalmente perpendicular y alineado perfectamente con la bañera.

5 variants of single-lever bath for exempt bathtub are created, and a set of columns that can be equipped with the taps to be selected. All the variants have a unique regulation system, which will help us to install it completely perpendicular and perfectly aligned with the bathtub.



**Monomando de pie para bañera**  
Floor single lever mixer for bath  
● Ref.: 64119 32 45 66 - **Chrome**  
● Ref.: 64119 32 41 66 - **Black**

Monomando de Pie para Bañera  
Floor Single-lever Mixer for Bath



Ref.: 64119 32 41 66



Acabados *Finishes*



Chrome

Black



**Monomando de ducha empotrado**  
Built-in single lever shower mixer

- Ref.: 64115 32 45 66 - **Chrome**
- Ref.: 64115 32 41 66 - **Black**



**Monomando empotrado con inversor 2 vías**  
2 way Built-in single lever mixer with diverter

- Ref.: 64116 32 45 66 - **Chrome**
- Ref.: 64116 32 41 66 - **Black**



**Monomando 2 vías empotrado**  
2 way Built-in single lever mixer

- Ref.: 64316 32 45 66 - **Chrome**
- Ref.: 64316 32 41 66 - **Black**



**¡Enlaza al video y conoce mejor nuestro sistema GEBOX!**

Link to the video and learn about our GEBOX system!



**Monomando empotrado con inversor cerámico 2 vías**

Built-in single lever mixer with 2-way ceramic diverter

- Ref.: 64117 32 45 66 - **Chrome**
- Ref.: 64117 32 41 66 - **Black**



**Monomando empotrado con inversor cerámico 3 vías**

Built-in single lever mixer with 3-way ceramic diverter

- Ref.: 64118 32 45 66 - **Chrome**
- Ref.: 64118 32 41 66 - **Black**



**Inversor cerámico 3 vías empotrado**  
Built-in 3-way ceramic diverter

- Ref.: 64114 30 45 66 - **Chrome**
- Ref.: 64114 30 41 66 - **Black**

Acabados *Finishes*



Chrome



Black

**GE-EASY: UNIC Control**



Un innovador concepto de columna de ducha extensible que incorpora un sistema de doble función en la maneta, desde donde accionar el rociador o el mango de ducha.

An innovative concept of extendable shower column that incorporate a dual function system in the actuator from which to operate the shower head or shower handle.

**UNIC Control:**

**Temperatura.** Temperature.

**Caudal.** Flow.

**Inversor.** Inverter.

- A** **Función rociador.**  
Shower head function.
- B** **Función mango de ducha.**  
Handshower function.
- C** **Stop.**



**Columna monomando extensible con kit**  
Single lever extendable column with kit

● Ref.: CM64110 32 - **Chrome**

● Ref.: CM64111 32 41 - **Black**





**Columna Monomando Extensible con Kit**  
Single Lever Extensible Column eith Kit





# Oslo

## Vanguardismo y sencillez Vanguardism and simplicity

**Una línea estilizada de formas depuradas y ángulos rectos es la base de la serie Oslo. Una nueva colección con diferentes alturas de caños, que proyecta elegancia y esbeltez y un avanzado diseño vanguardista donde cada detalle está pensado para embellecer el baño.**

*A stylized line of pure forms and right angles is the basis of the Oslo series. A new collection, with different spout heights, which projects elegance and slenderness, and has an advanced vanguardist design where each detail is intended to beautify the bathroom.*

# Oslo

Acabados Finishes

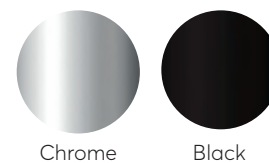

Chrome



Black

Consulta las especificaciones técnicas de los productos escaneando el QR  
Check the technical specifications of the products by scanning the QR



**Monomando de lavabo**  
Single lever wash-basin mixer

- Ref.: 65130 19 45 66 - **Chrome**
- Ref.: 65130 19 45 66 - **Black**



**Monomando de lavabo medio alto**  
Medium height single lever wash-basin mixer

- Ref.: 65134 19 45 66 - **Chrome**
- Ref.: 65134 19 41 66 - **Black**



**Monomando de lavabo alto**  
High single lever wash-basin mixer

- Ref.: 65136 19 45 66 - **Chrome**
- Ref.: 65136 19 41 66 - **Black**



**Monomando de lavabo apertura en frío**  
Single lever wash-basin mixer cold start

- Ref.: 65150 19 45 66 - **Chrome**



Monomando de Lavabo  
Wash-basin Mixer





**Monomando de Pie para Lavabo**  
Floor Single-lever Mixer for Basin



Ref.: 65139 19 41 66



La grifería GENE BRE está diseñada y fabricada según los estándares europeos de calidad, como la UNE-EN 19703 ofreciendo la funcionalidad, durabilidad y seguridad esperadas.

GENEBRE taps are designed and manufactured according to European quality standards, such as UNE-EN 19703, offering the expected functionality, durability and safety.



Para una instalación totalmente perpendicular y alineado.

Completely perpendicular and perfectly aligned installation.



NEW

**Monomando de Pie para lavabo OSLO**  
OSLO Floor single lever mixer for basin

● Ref.: 65139 19 45 66 - **Chrome**

● Ref.: 65139 19 41 66 - **Black**

Acabados *Finishes*



Chrome



Black

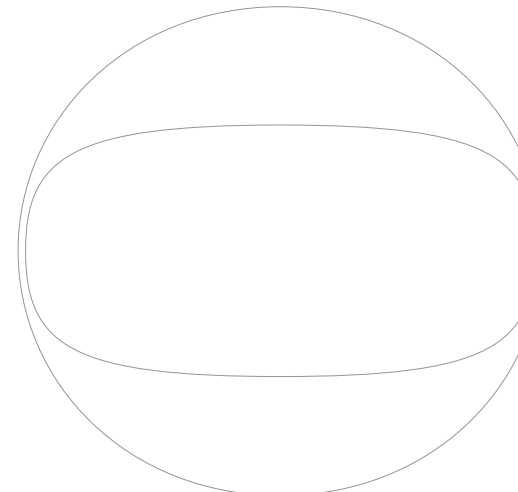
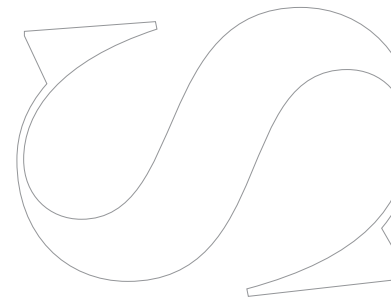
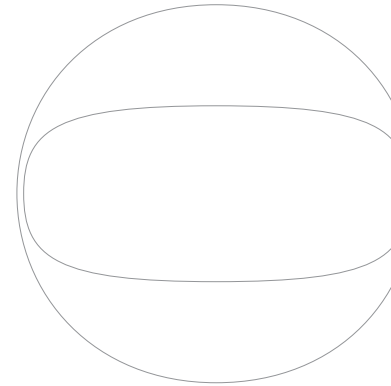



Acabados *Finishes*



Chrome



Black



NEW

**Monomando de lavabo empotrado caño 16 cm**

Built-in wash-basin mixer 16 cm spout

● Ref.: 65131 19 45 66 - **Chrome**

● Ref.: 65131 19 41 66 - **Black**



NEW

**Monomando de lavabo empotrado caño 22 cm**

Built-in wash-basin mixer 22 cm spout

● Ref.: 65132 19 45 66 - **Chrome**

● Ref.: 65132 19 41 66 - **Black**

**Monomandos de Lavabo Empotrados**  
Built-in Wash-basin Mixers



Ref.: 65132 19 45 66





**Monomando de bidé**  
Single lever bidet mixer

● Ref.: 65140 19 45 66 - **Chrome**  
● Ref.: 65140 19 41 66 - **Black**



**Monomando de bidé con transmisión**  
Single lever bidet mixer with diverter

● Ref.: 65142 19 45 66 - **Chrome**  
● Ref.: 65142 19 41 66 - **Black**



**Set mezclador sanitario de ducha con soporte**  
Sanitary shower mixer with support

● Ref.: 65144 19 45 67 - **Chrome**  
● Ref.: 65144 19 41 67 - **Black**



**Set mezclador sanitario de ducha con soporte**  
Sanitary shower mixer set with support

● Ref.: 65144 19 45 66 - **Chrome**



**Set mezclador Sanitario**  
Sanitary Shower Mixer

Ref.: 65144 19 45 66

Acabados *Finishes*



Chrome



Black



NEW

**Monomando de baño con kit**  
Single lever bath mixer with kit

- Ref.: 65100 19 45 66 - **Chrome**
- Ref.: 65100 19 41 66 - **Black**



NEW

**Monomando de ducha con kit**  
Single lever shower mixer with kit

- Ref.: 65110 19 45 66 - **Chrome**
- Ref.: 65110 19 41 66 - **Black**



**Mango de ducha C1 jet**  
C1 jet handshower

- Ref.: 100197 45 00 - **Chrome**

**Flexo H 1/2" - H 1/2" 1,70 m inoxidable**  
F 1/2" - F 1/2" Stainless steel flexible hose 1.70 m

- Ref.: 100135 60 00 - **Chrome**

**Soporte ducha cilíndrico**  
Cylindrical shower holder

- Ref.: 100153 45 - **Chrome**



NEW

**Monomando de ducha empotrado**  
Built-in single lever shower mixer

- Ref.: 65115 19 45 66 - **Chrome**
- Ref.: 65115 19 41 66 - **Black**



NEW

**Monomando empotrado con inversor 2 vías**  
2 way Built-in single lever mixer with diverter

- Ref.: 65116 19 45 66 - **Chrome**
- Ref.: 69115 19 41 66 - **Black**

## OSLO



NEW

**Set columna fija con kit**  
Fixed column set with kit

- Ref.: 1744 45 - **Chrome**
- Ref.: 1744 41 - **Black**



**Columna monomando fija con kit**  
Single lever fixed column with kit

- Ref.: CM65110 19 - **Chrome**
- Ref.: CM65111 19 41 - **Black**



**Columna termostática extensible con kit**  
Thermostatic fixed column with kit

- Ref.: CT67110 1 - **Chrome**
- Ref.: CT67111 19 41 - **Black**



Acabados *Finishes*



Chrome



Black



NEW

**Kit de ducha empotrado Oslo**

Oslo Built-in shower kit

● Ref.: ST116 19 - **Chrome**

● Ref.: SN111 19 41 - **Black**





**Kit de Ducha Empotrado**  
Built-in Shower Kit

REF.: ST1111941





OO

HOST

E CORPS  
TION



# Kode

## Robustez estilizada / Stylized robustness

**Inspirada en las nuevas tendencias, la nueva serie Kode deja entrever un estilo robusto y dinámico de maneta prominente con formas redondeadas que la matizan. Un magnífico diseño de alta gama creada para los baños de última generación.**

*Inspired in new trends, the new Kode series reveals a robust, dynamic style with a prominent handle with round forms that match. A magnificent high-end design created for new generation bathrooms.*

# Kode



Chrome



Consulta las especificaciones técnicas de los productos escaneando el QR  
Check the technical specifications of the products by scanning the QR



**Monomando de lavabo**  
Single lever wash-basin mixer  
● Ref.: 62130 08 45 66 - **Chrome**



**Monomando de lavabo alto**  
High single lever wash-basin mixer  
● Ref.: 62136 08 45 66 - **Chrome**

Monomandos de Lavabo  
Wash-basin Mixers







**Monomando de lavabo empotrado  
caño 16 cm**

Built-in wash-basin mixer  
16 cm spout

● Ref.: 62131 31 45 66 - **Chrome**



**Monomando de lavabo empotrado  
caño 22 cm**

Built-in wash-basin mixer  
22 cm spout

● Ref.: 62132 31 45 66 - **Chrome**



**Monomando de bidé**  
Single lever bidet mixer

● Ref.: 62140 08 45 66 - **Chrome**



**Monomando de bidé con transmisión**  
Single lever bidet mixer with diverter

● Ref.: 62142 31 45 66 - **Chrome**



**Monomando de baño sin kit**  
Single lever bath mixer without kit  
● Ref.: 62100 08 45 67 - **Chrome**



**Monomando de ducha sin kit**  
Single lever shower mixer without kit  
● Ref.: 62110 31 45 67 - **Chrome**



**\* Kit de ducha recomendado:**  
\* Recommended shower kit:

- Ref.: DXO3 45 - **Chrome**
- Ref.: 100137 60 00 - **Chrome**
- Ref.: 100068 45 - **Chrome**



**Monomando de pie para bañera Kode con sistema de anclaje único**  
Kode Floor single lever mixer for bath with unique fastening system  
● Ref.: 62119 31 45 66 - **Chrome**



Ref.: 62119 31 45 66





**Monomando de ducha empotrado**  
Built-in single lever shower mixer

● Ref.: 62115 31 45 66 - **Chrome**



**Monomando empotrado con inversor cerámico 2 vías**

Built-in single lever mixer with 2 way ceramic diverter

● Ref.: 62117 31 45 66 - **Chrome**



**Monomando empotrado con inversor cerámico 3 vías**

Built-in single lever mixer with 3 way ceramic diverter

● Ref.: 62118 31 45 66 - **Chrome**



**Inversor cerámico 3 vías empotrado con placa ovalada**

Built-in 3 way ceramic diverter with oval plate

● Ref.: 62114 30 45 66 - **Chrome**

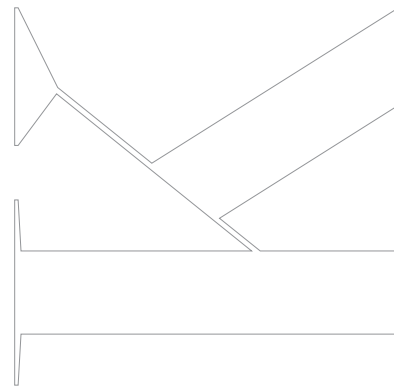
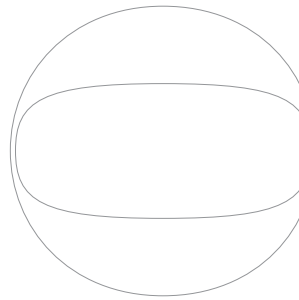
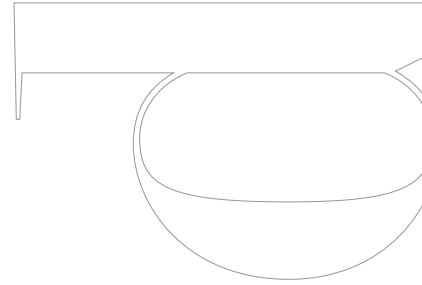
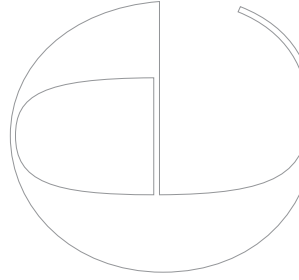

La grifería GENE BRE está diseñada y fabricada según los estándares europeos de calidad, como la UNE-EN 19703 ofreciendo la funcionalidad, durabilidad y seguridad esperadas.

GENEBRE taps are designed and manufactured according to European quality standards, such as UNE-EN 19703, offering the expected functionality, durability and safety.



**Inversor cerámico 3 vías empotrado con placa ovalada**

Built-in 3 way ceramic diverter with oval plate

● Ref.: 62114 30 45 66 - **Chrome**

**Monomando de ducha empotrado**

Built-in single lever shower mixer

● Ref.: 62115 31 45 66 - **Chrome**

**Rociador doble función cascada-lluvia**

Shower head double function waterfall-rain

● Ref.: 1643 45 - **Chrome**

**Toma ducha mural redonda**

Round wall connector

● Ref.: 1680 04 - **Chrome**

**Barra ducha TAU**

TAU shower bar

● Ref.: 1636 45 - **Chrome**

**Flexo extensible**

H 1/2" - H 1/2" 1,70 - 2,25 m inoxidable

F 1/2" - F 1/2" Extensible stainless steel flexible hose 1.70 to 2.25 m

● Ref.: 100137 60 00 - **Chrome**

**Mango de ducha O3 jets**

O3 jets handshower

● Ref.: DXO3 45 - **Chrome**

**Monomando empotrado con inversor cerámico 3 vías**

Built-in single lever mixer with 3 way ceramic diverter

● Ref.: 62118 31 45 66 - **Chrome**

**Brazo pared redondo 35 cm**

Round wall arm 35 cm

● Ref.: B65113 18 - **Chrome**

**Rociador D22 ovalado**

Oval D22 shower sprayer

● Ref.: R63112 08 - **Chrome**

**Toma ducha mural redonda**

Round wall connector

● Ref.: 1680 04 - **Chrome**

**Barra ducha TAU**

TAU shower bar

● Ref.: 1636 45 - **Chrome**

**Flexo extensible**

H 1/2" - H 1/2" 1,70 - 2,25 m inoxidable

F 1/2" - F 1/2" Extensible stainless steel flexible hose 1.70 to 2.25 m

● Ref.: 100137 60 00 - **Chrome**

**Mango de ducha O3 jets**

O3 jets handshower

● Ref.: DXO3 45 - **Chrome**

**Caño mural baño cilíndrico**

Round wall bath spout

● Ref.: 1668 45 - **Chrome**











# Klip

## Siempre actual / Stylized robustness

De líneas rectas y casi cuadradas ofrece un diseño sugerente que se integra con las tendencias de decoración de las cocinas y baños más modernos. Robusta, resistente y de belleza discreta, la colección Klip es una de nuestras colecciones más solicitadas.

*Straight, almost square lines offer a suggestive design that combines with the most modern decoration trends for kitchens and bathrooms. Robust, and resistant in its discreet beauty, the Klip series is one of our most sought after collections.*

Acabados Finishes

# Klip



Consulta las especificaciones técnicas de los productos escaneando el QR  
Check the technical specifications of the products by scanning the QR

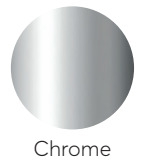

Chrome



**Monomando de lavabo**  
Single lever wash-basin mixer  
● Ref.: 64130 16 45 66 - **Chrome**



**Monomando de lavabo medio alto**  
Medium height single lever wash-basin mixer  
● Ref.: 64134 16 45 66 - **Chrome**



**Monomando de lavabo alto**  
High single lever wash-basin mixer  
● Ref.: 64136 16 45 66 - **Chrome**

**Sistema de apertura en frío**  
Cold start system  
● Ref.: 64150 16 45 66 - **Chrome**

Monomandos de Lavabo  
Wash-basin Mixers



Ref.: 64130 16 45 66





**Monomando de lavabo empotrado caño 16 cm**  
Built-in wash-basin mixer 16 cm spout

● Ref.: 64131 16 45 66 - **Chrome**



**Monomando de lavabo empotrado caño 22 cm**  
Built-in wash-basin mixer 22 cm spout

● Ref.: 64132 16 45 66 - **Chrome**



**Monomando de bidé**  
Single lever bidet mixer

● Ref.: 64140 16 45 66 - **Chrome**



**Monomando de bidé con transmisión**  
Single lever bidet mixer with diverter

● Ref.: 64142 16 45 66 - **Chrome**



**Monomando de baño con kit \***  
Single lever bath mixer with kit \*

● Ref.: 64100 16 45 66 - **Chrome**



**Monomando de ducha con kit \***  
Single lever shower mixer with kit \*

● Ref.: 64110 16 45 66 - **Chrome**



**\* Kit incluido**  
\* Kit included



**Monomando de ducha empotrado**  
Built-in single lever shower mixer

● Ref.: 64115 16 45 66 - **Chrome**



**Monomando empotrado con inversor 2 vías**  
2 way Built-in single lever mixer with diverter

● Ref.: 64116 16 45 66 - **Chrome**



**Monomando empotrado con inversor cerámico 2 vías**  
Built-in single lever mixer with 2-way ceramic diverter

● Ref.: 64117 04 45 66 - **Chrome**



**Monomando empotrado con inversor cerámico 3 vías**  
Built-in single handle mixer with 3-way ceramic diverter

● Ref.: 64118 04 45 66 - **Chrome**



**Inversor cerámico 3 vías empotrado con placa cuadrada**  
Built-in 3-way ceramic diverter with square plate

● Ref.: 65114 30 45 66 - **Chrome**



**Termostática baño**  
Thermostatic bath mixer

● Ref.: 67103 14 45 67 - **Chrome**



**Termostática ducha**  
Thermostatic shower mixer

● Ref.: 67104 14 45 67 - **Chrome**





**Monomando empotrado con inversor 2 vías**  
2 way Built-in single lever mixer with diverter  
● Ref.: 64116 16 45 66 - **Chrome**

**Brazo a techo redondo 15 cm**  
Round roof arm 15 cm  
● Ref.: 1671 45 - **Chrome**

**Rociador redondo 22 cm**  
Round shower head Ø 22 cm  
● Ref.: R65112 18 - **Chrome**

**Toma ducha mural redonda**  
Round wall connector  
● Ref.: 1680 04 - **Chrome**

**Conjunto Tau, barra, flexo y ducha 5 jets**  
Tau set, bar, hose and 5 jets handshower  
● Ref.: 1748 45 - **Chrome**



**Termostática baño**  
Thermostatic bath mixer  
● Ref.: 67103 14 45 67 - **Chrome**

**Set columna con ducha, soporte y flexo**  
Column set with shower, holder and flexible hose  
● Ref.: 1745 45 - **Chrome**



La grifería GENE BRE está diseñada y fabricada según los estándares europeos de calidad, como la UNE-EN 19703 ofreciendo la funcionalidad, durabilidad y seguridad esperadas.

GENEBRE taps are designed and manufactured according to European quality standards, such as UNE-EN 19703, offering the expected functionality, durability and safety.

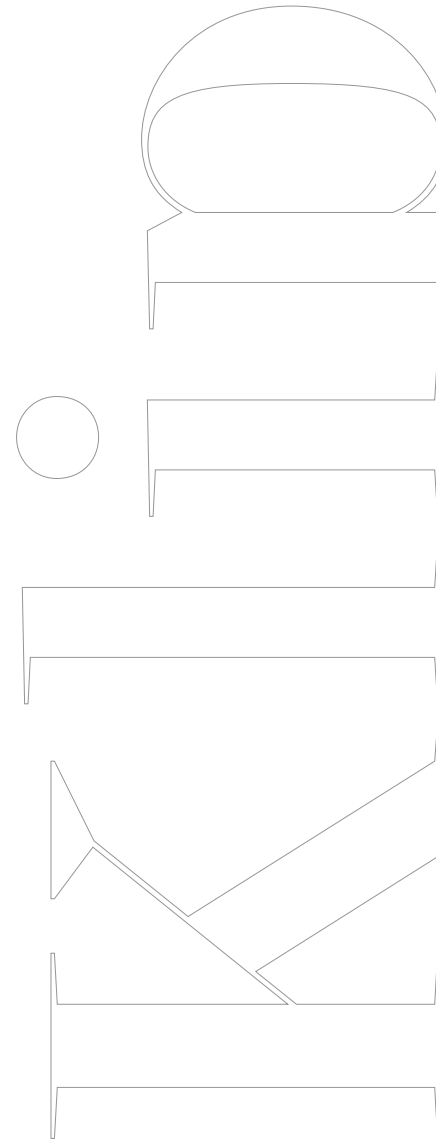



OLIVE & SAGE

GENEBRE



# Tau

## Espacios con carácter / Spaces with character

**Bella y seductora, la serie Tau transforma la cocina y el baño en espacios con estilo. Concebida a partir de un concepto de líneas cilíndricas y curvas estilizadas que realzan su silueta, cuenta con una gran gama de versiones que permiten adaptarla a todos los ambientes.**

*Beautiful and seductive, the Tau series transforms the kitchen and bathroom into spaces with style. Conceived from cylindrical lines and stylized curves that highlight its silhouette, there is a large variety that adapts to all types of ambiances.*

# Tau



Consulta las especificaciones técnicas de los productos escaneando el QR  
Check the technical specifications of the products by scanning the QR



Chrome



**Monomando de lavabo**  
Single lever wash-basin tap  
● Ref.: 65135 18 45 66 - **Chrome**



**Monomando de lavabo medio alto**  
Medium height single lever wash-basin mixer  
● Ref.: 65134 18 45 66 - **Chrome**



**Monomando de lavabo alto**  
High single lever wash-basin mixer  
● Ref.: 65136 18 45 66 - **Chrome**

**Monomandos de Lavabo**  
Wash-basin Mixers

Ref.: 65134 18 54 66

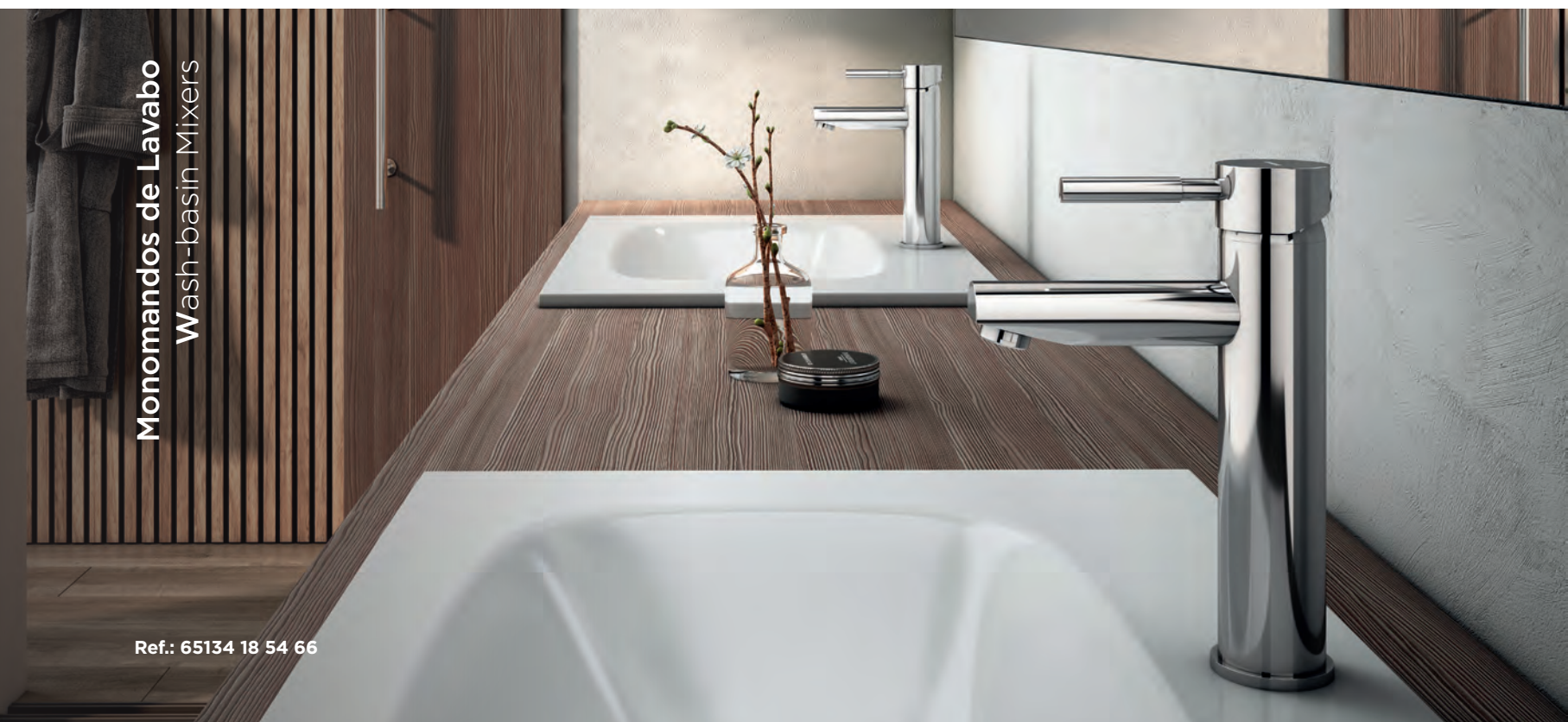





**Monomando de lavabo apertura en frío**  
Single lever wash-basin tap cold start  
● Ref.: 65138 18 45 66 - **Chrome**



**Monomando de lavabo empotrado caño 16 cm**  
Built-in wash-basin mixer 16 cm spout  
● Ref.: 65131 18 45 66 - **Chrome**



**Monomando de lavabo empotrado caño 22 cm**  
Built-in wash-basin mixer 22 cm spout  
● Ref.: 65132 18 45 66 - **Chrome**



**Monomando de bidé**  
Single lever bidet mixer  
● Ref.: 65145 18 45 66 - **Chrome**



**Monomando de bidé con transmisión**  
Single lever bidet mixer with diverter  
● Ref.: 65142 18 45 66 - **Chrome**



La grifería GENE BRE está diseñada y fabricada según los estándares europeos de calidad, como la UNE-EN 19703 ofreciendo la funcionalidad, durabilidad y seguridad esperadas.

GENEBRE taps are designed and manufactured according to European quality standards, such as UNE-EN 19703, offering the expected functionality, durability and safety.



**Monomando de baño con kit \***  
Single lever bath mixer with kit \*  
● Ref.: 65100 18 45 66 - **Chrome**



**Monomando de ducha con kit \***  
Single lever shower mixer with kit \*  
● Ref.: 65110 18 45 66 - **Chrome**



\* **Kit incluido**  
\* Kit included



**Monomando de pie para bañera Tau**  
Tau Floor single lever mixer for bath  
● Ref.: 65119 18 45 66 - **Chrome**

**NEW**



Se crean 5 variantes de monomando para bañera exenta, y un juego de columnas equipables con la grifería a escoger. Todas las variantes poseen un sistema de regulación único, el cuál nos ayudará a instalarlo totalmente perpendicular y alineado perfectamente con la bañera.

5 variants of single-lever bath for exempt bathtub are created, and a set of columns that can be equipped with the taps to be selected. All the variants have a unique regulation system, which will help us to install it completely perpendicular and perfectly aligned with the bathtub.





Set Columna con Ducha, Soporte y Flexo  
Column Set with Shower, Holder and Flexible Hose

# Tau



**Monomando de ducha empotrado**  
Built-in single lever shower mixer

● Ref.: 65115 18 45 66 - **Chrome**



**Monomando empotrado con inductor 2 vías**  
2 way Built-in single lever mixer with diverter

● Ref.: 65116 18 45 66 - **Chrome**



**Monomando empotrado con inductor cerámico 2 vías**  
Built-in single lever mixer with 2-way ceramic diverter

● Ref.: 65117 18 45 66 - **Chrome**



**Monomando empotrado con inductor cerámico 3 vías**  
Built-in single lever mixer with 3-way ceramic diverter

● Ref.: 65118 18 45 66 - **Chrome**



**Inductor cerámico 3 vías empotrado con placa cuadrada**  
Built-in 3-way ceramic diverter with square plate

● Ref.: 65114 30 45 66 - **Chrome**

NEW





**Termostática baño**  
Thermostatic bath mixer  
● Ref.: 67102 14 45 67 - **Chrome**



**Termostática ducha**  
Thermostatic shower mixer  
● Ref.: 67112 14 45 67 - **Chrome**



Ref.: 67112 14 45 67



**Termostática empotrada 2 vías**  
Built-in 2-way thermostatic mixer  
● Ref.: 64114 14 45 67 - **Chrome**



**Termostática empotrada 3 vías**  
Built-in 3-way thermostatic  
● Ref.: 64111 14 45 67 - **Chrome**



**Columna monomando extensible con kit**  
Single lever extensible column with kit  
● Ref.: CM65110 18 - **Chrome**



**Columna termostática extensible con kit**  
Thermostatic extensible column with kit  
● Ref.: CT67110 18 - **Chrome**



**Set columna con ducha, soporte y flexo**  
Column set with shower, holder and flexible hose  
● Ref.: 1745 45 - **Chrome**





Columna Monomando Extensible con Kit  
Single-lever Extensible Column with Kit







# Tau 2

## Mezcla de formas / Mixture of forms

**Una colección con mucha personalidad que se sumerge en el contraste de las formas. El caño cilíndrico que proviene de la serie TAU convive con una maneta de formas totalmente rectas. Una fusión que aporta a esta colección un aire más actual.**

*A collection with a lot of personality is immersed in the contrast of forms. The cylindric spout that comes from the TAU series co-exists with a handle with totally straight lines. A fusion that contributes an air of modernity to the collection.*

# Tau 2



Consulta las especificaciones técnicas de los productos escaneando el QR  
Check the technical specifications of the products by scanning the QR



Chrome



**Monomando de lavabo**  
Single lever wash-basin mixer

● Ref.: 65135 29 45 66 - **Chrome**



**Monomando de lavabo medio alto**  
Medium height single lever wash-basin mixer

● Ref.: 65134 29 45 66 - **Chrome**



**Monomando de lavabo alto**  
High single lever wash-basin mixer

● Ref.: 65136 29 45 66 - **Chrome**



**Monomando de lavabo empotrado caño 16 cm**  
Built-in wash-basin mixer 16 cm spout

● Ref.: 65131 29 45 66 - **Chrome**



**Monomando de lavabo empotrado caño 22 cm**  
Built-in wash-basin mixer 22 cm spout

● Ref.: 65132 29 45 66 - **Chrome**





La grifería GENEBRE está diseñada y fabricada según los estándares europeos de calidad, como la UNE-EN 19703 ofreciendo la funcionalidad, durabilidad y seguridad esperadas.

GENEBRE taps are designed and manufactured according to European quality standards, such as UNE-EN 19703, offering the expected functionality, durability and safety.



**Monomando de bidé**  
Single lever bidet mixer

● Ref.: 65145 29 45 66 - **Chrome**



**Monomando de bidé con transmisión**  
Single lever bidet mixer with diverter

● Ref.: 65142 29 45 66 - **Chrome**



**Monomando de baño con kit \***  
Single lever bath mixer with kit \*

● Ref.: 65100 29 45 66 - **Chrome**



**Monomando de ducha con kit \***  
Single lever shower mixer with kit \*

● Ref.: 65110 29 45 66 - **Chrome**



**\* Kit incluido**  
\* Kit included

MINA



**Monomando de ducha empotrado**

Built-in single lever shower mixer

● Ref.: 65115 29 45 66 - **Chrome**



**Monomando empotrado con inversor 2 vías**

2 way Built-in single lever mixer with diverter

● Ref.: 65116 29 45 66 - **Chrome**



**Monomando de pie para bañera Tau 2**

Tau 2 Floor single lever mixer for bath

● Ref.: 65119 29 45 66 - **Chrome**



**Se crean 5 variantes de monomando para bañera exenta, y un juego de columnas equipables con la grifería a escoger.**

**Todas las variantes poseen un sistema de regulación único, el cuál nos ayudará a instalarlo totalmente perpendicular y alineado perfectamente con la bañera.**

5 variants of single-lever bath for exempt bathtub are created, and a set of columns that can be equipped with the taps to be selected. All the variants have a unique regulation system, which will help us to install it completely perpendicular and perfectly aligned with the bathtub.

**NEW**





**Columna monomando extensible con kit**  
 Single lever extensible column with kit  
 ● Ref.: CM65110 29 - **Chrome**



**Columna termostática extensible con kit**  
 Thermostatic extensible column with kit  
 ● Ref.: CT67110 18 - **Chrome**



**Set columna con ducha, soporte y flexo**  
 Column set with shower, holder  
 and flexible hose  
 ● Ref.: 1745 45 - **Chrome**









# Kenjo

**Creada para sentir el placer del agua.  
Created to feel the pleasure of water.**

**Diseño de gran belleza minimalista, con cuidadas formas rectas y una minuciosa atención a los detalles la convierten en una gama muy especial. Elegante y sobria, pero a la vez espectacular. La salida del agua es libre o tipo cascada que proporciona un chorro limpio y natural para disfrutar de momentos de intenso placer.**

*A design with great minimalist beauty, careful straight lines, and a meticulous attention to detail make it a very special range. Elegant and simple, yet spectacular at the same time. The water outlet is free or waterfall-style and gives a clean and natural stream to enjoy the pleasures of water.*

# Kenjo



Consulta las especificaciones técnicas de los productos escaneando el QR  
Check the technical specifications of the products by scanning the QR



Chrome



## Monomando de lavabo

Single lever wash-basin mixer

● Ref.: 63130 26 45 66 - **Chrome**



## Monomando de lavabo medio alto

Medium height single lever wash-basin mixer

● Ref.: 63134 26 45 66 - **Chrome**



## Monomando de lavabo alto

High single lever wash-basin mixer

● Ref.: 63136 26 45 66 - **Chrome**



## Monomando de lavabo cascada

Waterfall single lever wash-basin mixer

● Ref.: 63137 26 45 66 - **Chrome**



## Monomando de lavabo cascada alto

High waterfall single lever wash-basin mixer

● Ref.: 63138 26 45 66 - **Chrome**



**Monomando de Lavabo**  
Wash-basin Mixer



Ref.: 63137 26 45 66





**Monomando de lavabo empotrado caño 16 cm**  
Built-in wash-basin mixer 16 cm spout  
● Ref.: 63131 26 45 66 - **Chrome**



**Monomando de lavabo empotrado caño 22 cm**  
Built-in wash-basin mixer 22 cm spout  
● Ref.: 63132 26 45 66 - **Chrome**



**Monomando de bidé**  
Single lever bidet mixer  
● Ref.: 63140 26 45 66 - **Chrome**



**Monomando de bidé con transmisión**  
Single lever bidet mixer with diverter  
● Ref.: 63142 26 45 66 - **Chrome**



**Monomando de baño sin kit**  
Single lever bath mixer without kit  
● Ref.: 63100 26 45 67 - **Chrome**



**Monomando de ducha sin kit**  
Single lever shower mixer without kit  
● Ref.: 63110 26 45 67 - **Chrome**



**\* Kit de ducha recomendado:**  
\* Recommended shower kit:

**Mango de ducha K3 jets**  
K3 jets handshower  
● Ref.: DXK3 45 - **Chrome**

**Flexo H 1/2" - H 1/2" 1,70 m inoxidable**  
F 1/2" - F 1/2" Stainless steel flexible hose 1.70 m  
● Ref.: 100135 60 00 - **Chrome**

**Soporte ducha Kenjo**  
Kenjo shower holder  
● Ref.: 100149 45 - **Chrome**





**Monomando de ducha empotrado**  
Built-in single lever shower mixer  
● Ref.: 63115 26 45 66 - **Chrome**



**Monomando empotrado con inversor 2 vías**  
2 way Built-in single lever mixer with diverter  
● Ref.: 63116 26 45 66 - **Chrome**



**Termostática ducha sin kit**  
Thermostatic shower mixer without kit  
● Ref.: 67110 26 45 67 - **Chrome**



**Monomando de pie para bañera Kenjo**  
Kenjo Floor single lever mixer for bath  
● Ref.: 63119 26 45 66 - **Chrome**



**Monomando de Pie para Bañera**  
Single Lever Mixer for Bath

Ref.: 67112 14 45 67



Columna Extensible con Kit  
Extensible Column with Kit



Ref.: CT67110 26





**Columna monomando extensible con kit**  
Single lever extensible column with kit  
● Ref.: CM63110 26 - **Chrome**



**Columna termostática extensible con kit**  
Thermostatic extensible column with kit  
● Ref.: CT67110 26 - **Chrome**



**Set columna con ducha, soporte y flexo**  
Extensible column set with shower, holder  
and flexible hose  
● Ref.: 1746 45 - **Chrome**







# K8

## La sencillez convertida en diseño / Simply design

**A veces, lo más sencillo puede ser inolvidable. Como esta colección de formas discretas y sutiles, combinadas con delicadas líneas curvas y rectas que le confieren una personalidad única y la convierten en la elección ideal para el baño o la cocina.**

*Sometimes the simplest things can be unforgettable. Like this collection of discreet, subtle forms, combined with delicate curved and straight lines which give it a unique personality and make it the ideal choice for the bathroom and the kitchen.*

# K8

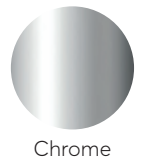

Consulta las especificaciones técnicas de los productos escaneando el QR  
Check the technical specifications of the products by scanning the QR



**Monomando de lavabo Plus**  
Single lever wash-basin mixer

● Ref.: 61130 28 45 66 - **Chrome**



**Monomando de lavabo medio alto**  
Medium height single lever wash-basin mixer

● Ref.: 60134 28 45 66 - **Chrome**



**Monomando de lavabo alto**  
High single lever wash-basin mixer

● Ref.: 60136 28 45 66 - **Chrome**

**Apertura en frío**  
Cold start

● Ref.: 61150 28 45 66 - **Chrome**



**Monomando de lavabo**  
Single lever wash-basin mixer

● Ref.: 60150 28 45 66 - **Chrome**



**Apertura en frío**  
Cold start

● Ref.: 60130 28 45 66 - **Chrome**



**Monomando de Lavabo**  
Single-lever Wash-basin Mixer

Ref.: 60150 28 45 66





**Monomando de lavabo centerset 4"**  
Single lever wash-basin mixer 4" centerset  
● Ref.: 60188 28 45 66 - **Chrome**



**Monomando de Lavabo**  
Single-lever Wash-basin Mixer

Ref.: 60188 28 45 66



**Monomando de bidé**  
Single lever bidet mixer  
● Ref.: 60140 28 45 66 - **Chrome**



**Monomando de bidé con transmisión**  
Single lever bidet mixer with diverter  
● Ref.: 61142 28 45 66 - **Chrome**

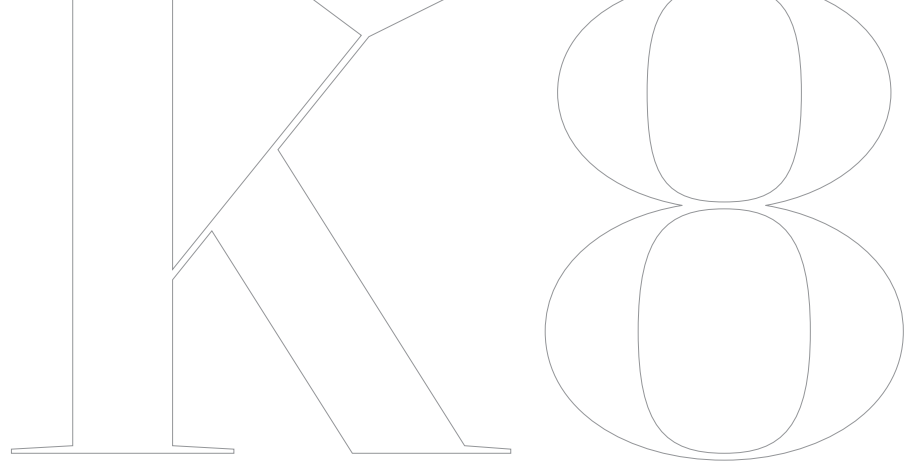

**Monomando de baño con kit**  
Single lever bath mixer with kit  
● Ref.: 60100 28 45 66 - **Chrome**



**Monomando de ducha con kit**  
Single lever shower mixer with kit  
● Ref.: 60110 28 45 66 - **Chrome**



\* **Kit incluido**  
\* Kit included



**Monomando de ducha empotrado**  
Built-in single lever shower mixer  
● Ref.: 61115 28 45 66 - **Chrome**



**Monomando empotrado con inversor 2 vías**  
2 way Built-in single lever mixer with diverter  
● Ref.: 61116 28 45 66 - **Chrome**



La grifería GENE BRE está diseñada y fabricada según los estándares europeos de calidad, como la UNE-EN 19703 ofreciendo la funcionalidad, durabilidad y seguridad esperadas.

GENEBRE taps are designed and manufactured according to European quality standards, such as UNE-EN 19703, offering the expected functionality, durability and safety.





Monomando de Baño con Kit  
Single Lever Bath Mixer with Kit





19-69  
KASBA  
EAU DE PARFUM



# Ge2

**La grandeza de lo sencillo.  
The greatness of the simple.**

**Sencillez y dinamismo, de formas naturales y energicas son los atributos que definen esta sugerente colección. Sus líneas curvas y, a la vez, inclinadas y ergonómicas, su resistencia y su gran fiabilidad le otorgan un aspecto inconfundible.**

*Simplicity and dynamism, with natural energetic forms, are the attributes that define this suggestive collection. Its curved and ergonomic lines, ireresistance and great reliability give it a striking appearance.*

# Ge2

Acabados Finishes



Chrome



Consulta las especificaciones técnicas de los productos escaneando el QR  
Check the technical specifications of the products by scanning the QR



**Monomando de lavabo Plus**  
Single lever Plus wash-basin mixer  
● Ref.: 61130 22 45 66 - **Chrome**



**Monomando de lavabo**  
Single lever wash-basin mixer  
● Ref.: 60130 22 45 66 - **Chrome**



**Monomando de lavabo centerset 4"**  
Single lever wash-basin mixer 4" centerset  
● Ref.: 60188 22 45 66 - **Chrome**



**Monomando de bidé**  
Single lever bidet mixer  
● Ref.: 60140 22 45 66 - **Chrome**



**Monomando de bidé con transmisión**  
Single lever bidet mixer with diverter  
● Ref.: 61142 22 45 66 - **Chrome**





**Monomando de baño con kit**  
Single lever bath mixer with kit  
● Ref.: 60100 22 45 66 - **Chrome**



**Monomando de ducha con kit**  
Single lever shower mixer with kit  
● Ref.: 60110 22 45 66 - **Chrome**



\* **Kit incluido**  
\* Kit included



**Monomando de ducha empotrado**  
Built-in single lever shower mixer  
● Ref.: 61115 22 45 66 - **Chrome**



**Monomando empotrado con inversor 2 vías**  
2 way Built-in single lever mixer with diverter  
● Ref.: 61116 22 45 66 - **Chrome**



La grifería GENE BRE está diseñada y fabricada según los estándares europeos de calidad, como la UNE-EN 19703 ofreciendo la funcionalidad, durabilidad y seguridad esperadas.

GENEBRE taps are designed and manufactured according to European quality standards, such as UNE-EN 19703, offering the expected functionality, durability and safety.



**Monomando empotrado con inversor 2 vías**  
2 way Built-in single lever mixer with diverter

● Ref.: 61116 22 45 66 - **Chrome**

**Rociador ducha con brazo**  
Wall shower arm and spray

● Ref.: 1698 45 00 - **Chrome**

**Caño mural baño fundido**  
Casted wall bath spout

● Ref.: 1667 45 - **Chrome**

**Monomando empotrado con inversor 2 vías**  
2 way Built-in single lever mixer with diverter

● Ref.: 61116 22 45 66 - **Chrome**

**Brazo pared redondo 35 cm**  
Round wall arm 35 cm

● Ref.: B65113 18 - **Chrome**

**Rociador redondo 22 cm**  
Round shower head Ø 22 cm

● Ref.: R65112 18 - **Chrome**

**Barra ducha redonda**  
Round shower bar

● Ref.: 1638 45 - **Chrome**

**Toma ducha mural redonda**  
Round wall connector

● Ref.: 1680 04 - **Chrome**

**Mango de ducha E2 jets**  
E2 jets handshower

● Ref.: DXE2 45 - **Chrome**

**Flexo H 1/2" - H 1/2" 1,70 m inoxidable**  
F 1/2" - F 1/2" Stainless steel flexible hose 1.70 m

● Ref.: 100135 60 00 - **Chrome**





**Grifo lavabo 1 agua cartucho 25**  
 One-water wash-basin tap 25 cartridge  
 ● Ref.: 1002 04 - **Chrome**



**Grifo lavabo mural 1 agua cartucho 25**  
 One-water wall wash-basin tap 25 cartridge  
 ● Ref.: 1003 04 - **Chrome**



**Grifo doble combinable 1/2"-3/4" y 1/2"**  
 Double outlet tap 1/2"-3/4" and 1/2"  
 ● Ref.: 1023 04 - **Chrome**



**Grifo doble combinable a 1/2"- 3/4" y Aireador**  
 Double outlet tap 1/2" - 3/4" and aerator  
 ● Ref.: 1024 04 - **Chrome**

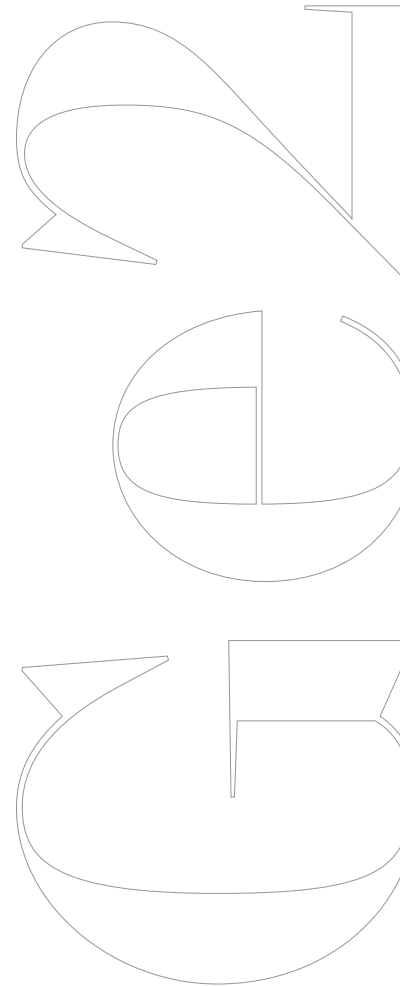



**Grifo lavabo mural 1 agua cartucho 25**  
One-water wall wash-basin tap 25 cartridge  
● Ref.: 1006 04 - **Chrome**



**Grifo lavabo 1 agua cartucho 25**  
One-water wash-basin tap 25 cartridge  
● Ref.: 1007 04 - **Chrome**



**Grifo bide mural 1 agua**  
1 water wall bidet  
● Ref.: 60001 22 45 67 - **Chrome**



**Flexo H 1/2" - H 1/2" 1,20 m inoxidable**  
F 1/2" - F 1/2" Stainless steel flexible hose 1.20 m  
● Ref.: 100141 45 - **Chrome**

**Kit ducha sanitaria**  
Sanitary shower kit  
● Ref.: 100696 45 - **Chrome**

Consulte la ficha técnica de nuestros productos: Para encontrar toda la información técnica de cualquier producto, localice la referencia del artículo al final de este catálogo, o en nuestra web.

Consult data sheet of our products: Use the item reference to find all of the technical information on any of our products, at the end of this catalogue or our web.







**Grifo Lavabo 1 Agua**  
One-water Wash-basin Tap

Ref.: 1002 04







# New Regent Classic

## Glamour vintage / Vintage glamour

La serie New Regent Classic readapta el estilo más clásico, y a veces de elegancia barroca, a los baños y cocinas de hoy. Un excelente y refinado maridaje de calidad, glamour y estilo vintage que nos transporta a épocas lejanas. Disponibles en acabados cromo o bronce.

*The New Regent Classic series readapts a most classic style, almost barroque in elegance, to the bathrooms and kitchens of today. An excellent and refined blend of quality, glamour and vintage style that transports us to ancient times. Available in chrome and bronze finidhes..*

# New Regent Classic

Acabados Finishes:



Chrome



Bronze



Consulta las especificaciones técnicas de los productos escaneando el QR  
Check the technical specifications of the products by scanning the QR



## Monobloc de lavabo cromo

Chrome wash-basin mixer

● Ref.: 68506 09 45 66 - **Chrome**



## Monobloc de bidé cromo

Chrome bidet mixer

● Ref.: 68516 09 45 66 - **Chrome**



## Mezclador de baño cromo con kit \*

Chrome bath mixer with kit \*

● Ref.: 68526 09 45 66 - **Chrome**



## Mezclador de ducha cromo con kit \*

Chrome shower mixer with kit \*

● Ref.: 68531 09 45 66 - **Chrome**



\* **Kit incluido**

\* **Kit included**



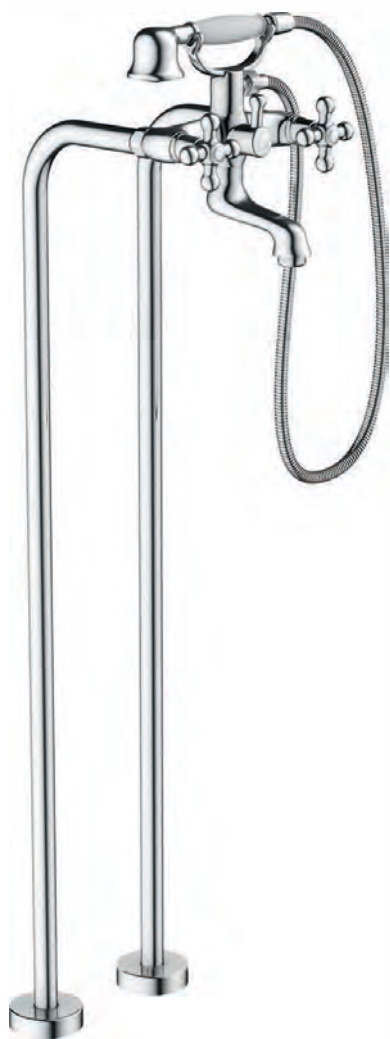

NEW

**Pies para mezclador de bañera \***  
Floor support for bath mixer \*

● Ref.: 65120 45 - **Chrome**

\* **Mezclador de baño no incluido**  
\* Bath mixer not included

**Mezclador de baño cromo**  
Chrome bath mixer

● Ref.: 68526 09 45 66 - **Chrome**



**Pies para mezclador para Bañera**  
Floor Support for Bath Mixer

Ref.: 65120 45

# New Regent Classic



**Monobloc de lavabo**  
Wash-basin mixer

● Ref.: 68506 09 43 66 - **Bronze**



**Monobloc bidet**  
Bidet mixer

● Ref.: 68516 09 43 66 - **Bronze**



**Mezclador de baño con kit \***  
Bath mixer with kit \*

● Ref.: 68526 09 43 66 - **Bronze**



**Mezclador de ducha con kit \***  
Shower mixer with kit \*

● Ref.: 68531 09 43 66 - **Bronze**



\* **Kit incluido**  
\* Kit included



# Classic

Acabados Finishes:



Chrome



Bronze



**Llave de paso 1/2"**  
Stopcock 1/2"

● Ref.: 68590 09 43 66 - **Bronze**



**Brazo pared redondo 35cm**  
Round wall arm 35cm

● Ref.: B64113 43 - **Bronze**

**Rociador redondo 20cm**  
round shower head 20cm

● Ref.: R68113 43 - **Bronze**



**Válvula universal click para bañera**  
Click pop-up waste for bath

● Ref.: 100208 43 - **Bronze**



**Válvula universal click Luxe con y sin rebosadero**

Luxe universal click pop-up waste with and without overflow

● Ref.: 100211 43 - **Bronze**



La grifería GENE BRE está diseñada y fabricada según los estándares europeos de calidad, como la UNE-EN 19703 ofreciendo la funcionalidad, durabilidad y seguridad esperadas.

GENEBRE taps are designed and manufactured according to European quality standards, such as UNE-EN 19703, offering the expected functionality, durability and safety.







# New Regent

## Distinción y elegancia clásica Classic distinction and elegance

De líneas curvas y volantes en cruz, esta colección está impregnada del estilo vintage del modelo New Regent Classic. Insinuando el pasado, sus líneas más sencillas y evocadoras la convierten en una bella selección de grifos que aportan un toque de romanticismo al ambiente.

*With curved lines and cross handled wheels, this collection is permeated with full of vintage style from the New Regent Classic model. Insinuating the past, its simple and evocative lines makes it a beautiful selection of taps that add a touch of romanticism to the ambience.*

Acabados Finishes

# New Regent



Chrome



Consulta las especificaciones técnicas de los productos escaneando el QR  
Check the technical specifications of the products by scanning the QR



**Monobloc de lavabo**

Wash-basin mixer

● Ref.: 68505 09 45 66 - **Chrome**



**Batería lavabo**

Widespread wash-basin mixer

● Ref.: 68510 09 45 66 - **Chrome**



**Batería lavabo**

Widespread wash-basin mixer

● Ref.: 68120 09 45 66 - **Chrome**

**Batería Lavabo**  
Widespread Wash-basin Mixer

Ref.: 68510 09 45 66







**Mezclador lavabo 4"**  
Wash-basin mixer 4"

● Ref.: 68511 09 45 66 - **Chrome**



**Grifo lavabo**  
Wash-basin tap

● Ref.: 68500 09 45 66 - **Chrome**



**Monobloc de bidé**  
Bidet mixer

● Ref.: 68515 09 45 66 - **Chrome**



**Grifo bidé**  
Bidet tap

● Ref.: 68520 09 45 66 - **Chrome**



**Batería de bidé con transmisión**  
Widespread bidet mixed with transmission

● Ref.: 68142 09 45 66 - **Chrome**



**Mezclador de baño con kit \***  
Bath mixer with kit \*

● Ref.: 68525 09 45 66 - **Chrome**



**Mezclador de ducha con kit \***  
Shower mixer with kit \*

● Ref.: 68530 09 45 66 - **Chrome**



\* **Kit incluido**  
\* Kit included

# New Regent



**Grupo de lavabo empotrado**  
Built-in wash-basin mixer  
● Ref.: 68131 09 45 66 - **Chrome**



**Grupo ducha empotrado 8"**  
Built-in 8" shower mixer  
● Ref.: 68535 09 45 66 - **Chrome**



**Grupo baño empotrado 8" con inversor**  
Built-in 8" bath mixer with diverter  
● Ref.: 68527 09 45 66 - **Chrome**



**Llave de paso 1/2"**  
Stopcock 1/2"  
● Ref.: 68590 09 45 66 - **Chrome**



**Grifo de bidé con teleducha**  
Bidet tap with shower  
● Ref.: 68001 09 45 66 - **Chrome**



Batería Lavabo  
Widespread Wash-basin Mixer



Ref.: 68120 09 45 66





GENEBRE



# Gamma

## Discreción intencionada / Intentional discretion

**Sencilla y discreta. Ideal para aquellos espacios que buscan funcionalidad. De estilo bimando y características clásicas, los grifos de esta serie ofrecen un excelente equilibrio entre su diseño sereno y la alta calidad.**

*Simple and discreet. Ideal for those spaces seeking functionality. With dual handles and classic features, the taps in this series offer an excellent balance between their serene design and high quality.*

# Gamma

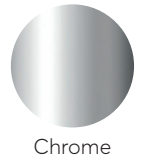

Consulta las especificaciones técnicas de los productos escaneando el QR  
Check the technical specifications of the products by scanning the QR



**Monobloc de lavabo**  
Wash-basin mixer

● Ref.: 68130 11 45 66 - **Chrome**



**Batería de lavabo**  
Widespread wash-basin mixer

● Ref.: 68120 11 45 66 - **Chrome**



**Mezclador lavabo 4"**  
Wash-basin mixer 4"

● Ref.: 68122 11 45 66 - **Chrome**



**Grifo de lavabo**  
Wash-basin tap

● Ref.: 68180 11 45 66 - **Chrome**



La grifería GENE BRE está diseñada y fabricada según los estándares europeos de calidad, como la UNE-EN 19703 ofreciendo la funcionalidad, durabilidad y seguridad esperadas.

GENEBRE taps are designed and manufactured according to European quality standards, such as UNE-EN 19703, offering the expected functionality, durability and safety.



# Gamma



**Monobloc de bidé**  
Bidet mixer

● Ref.: 68140 11 45 66 - **Chrome**



**Grifo bidé**  
Bidet tap

● Ref.: 68160 11 45 66 - **Chrome**



**Batería de bidé con transmisión**

Widespread bidet mixer with transmission

● Ref.: 68142 11 45 66 - **Chrome**



**Mezclador de baño con kit \***  
Bath mixer with kit \*

● Ref.: 68100 11 45 66 - **Chrome**



**Mezclador de ducha con kit \***  
Shower mixer with kit \*

● Ref.: 68110 11 45 66 - **Chrome**



**\* Kit incluido**  
\* Kit included



**Grupo de lavabo empotrado**

Built-in wash-basin

● Ref.: 68131 11 45 66 - **Chrome**



**Grupo ducha empotrado 8"**

Built-in 8" shower mixer

● Ref.: 68115 11 45 66 - **Chrome**

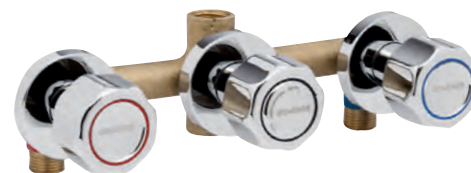

**Grupo baño empotrado 8" con inversor**

Built-in 8" bath mixer with diverter

● Ref.: 68116 11 45 66 - **Chrome**



**Llave de paso 1/2"**

Stopcock 1/2"

● Ref.: 68170 11 45 66 - **Chrome**



**Grifo de bidé con teleducha**

Bidet tap with shower

● Ref.: 68001 11 45 66 - **Chrome**



Consulte la ficha técnica de nuestros productos: Para encontrar toda la información técnica de cualquier producto, localice la referencia del artículo al final de este catálogo, o en nuestra web.

Consult data sheet of our products: Use the item reference to find all of the technical information on any of our products, at the end of this catalogue or our web.













# Ixo

## Infinitas posibilidades / Infinite possibilities

**Fusión entre elegancia clásica y minimalismo. Los volantes del modelo Ixo de formas geométricas y muy estilizadas son ideales para conjuntar con las múltiples posibilidades de caños que ofrece la colección. Un diseño actual y hermoso que consigue un ambiente muy especial.**

*A fusion of classic elegance and minimalism. The handles of the Ixo model with geometric stylised forms are ideal to match with the multiple possibilities of spouts that the collection offers. A current, attractive design that achieves a very special ambience.*

# Ixo



Chrome



Consulta las especificaciones técnicas de los productos escaneando el QR  
Check the technical specifications of the products by scanning the QR



**Batería de lavabo caño recto**  
Widespread wash-basin mixer with straight pipe spout  
● Ref.: 68120 12 45 66 - **Chrome**



**Batería de lavabo caño cisne**  
Widespread wash-basin mixer with swan pipe spout  
● Ref.: 68124 12 45 66 - **Chrome**



**Batería de lavabo caño inclinado**  
Widespread wash-basin mixer with sloping pipe spout  
● Ref.: 68125 12 45 66 - **Chrome**

**Batería Lavabo Caño Cisne**  
Widespread Wash-basin Mixer  
with Swan Pipe Spout

Ref.: 68124 12 45 66





Las series Kalo, Kross e Ixo nacen de la combinación de diferentes componentes: cuerpos, caños y volantes. Busque la combinación que mejor se adapte a su baño. Puede pedirla utilizando la referencia del catálogo (conjunto) o bien por referencia de cada uno de los componentes (ver información técnica en la página 267).

The series Kalo, Kross and Ixo are born from the combination of different components: bodies, pipes and handles. Look for the combination that best suits your bathroom. You can order it using the set reference or by components reference (see technical information on page 267).



**Grupo de lavabo empotrado caño 16 cm**

Built-in wash-basin mixer with 16 cm pipe spout

● Ref.: 68131 12 45 66 - **Chrome**



**Grupo de lavabo empotrado caño 22 cm**

Built-in wash-basin mixer with 22 cm pipe spout

● Ref.: 68132 12 45 66 - **Chrome**



**Grupo ducha empotrado 8"**

Built-in 8" shower mixer

● Ref.: 68115 12 45 66 - **Chrome**



**Grupo ducha empotrado 8" con inversor**

Built-in 8" shower mixer with diverter

● Ref.: 68116 12 45 66 - **Chrome**



**Inversor cerámico 3 vías empotrado placa redonda**

Built-in 3 way ceramic diverter with round plate

● Ref.: 63114 30 45 66 - **Chrome**



**Batería de baño con inversor**

Widespread bath mixer with diverter

● Ref.: 68113 12 45 66 - **Chrome**



**Batería de bidé con transmisión**

Widespread bidet mixer with transmission

● Ref.: 68142 12 45 66 - **Chrome**



**Llave de paso 1/2"**

Stopcock 1/2"

● Ref.: 68170 12 45 66 - **Chrome**





# Kross

## En la variedad está el gusto / A taste for diversity

**Los volantes de la serie Kross están diseñados para ser los protagonistas de los baños más elegantes. Y la posibilidad de combinarse con diferentes tipos de caños le permite múltiples opciones para adaptarse a cada estilo de baño.**

*The handle in the Kross series are designed to be the main focus of the most elegant bathrooms. They offer the possibility to combine with different types of spouts that allow for multiple options to adapt to each style of bathroom.*

# Kross

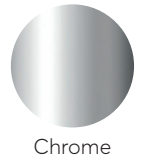

Consulta las especificaciones técnicas de los productos escaneando el QR  
Check the technical specifications of the products by scanning the QR



**Batería de lavabo caño recto**  
Widespread wash-basin mixer  
with straight pipe spout

● Ref.: 68120 08 45 66 - **Chrome**



**Batería de lavabo caño cisne**  
Widespread wash-basin mixer  
with swan pipe spout

● Ref.: 68124 08 45 66 - **Chrome**



**Batería de lavabo caño inclinado**  
Widespread wash-basin mixer  
with sloping pipe spout

● Ref.: 68125 08 45 66 - **Chrome**



**Batería Lavabo Caño Cisne**  
Widespread Wash-basin Mixer  
with Swan Pipe Spout

Ref.: 68124 05 45 66



Las series Kalo, Kross e Ixo nacen de la combinación de diferentes componentes: cuerpos, caños y volantes. Busque la combinación que mejor se adapte a su baño. Puede pedirla utilizando la referencia del catálogo (conjunto) o bien por referencia de cada uno de los componentes (ver información técnica en la página 265).

The series Kalo, Kross and Ixo are born from the combination of different components: bodies, pipes and handles. Look for the combination that best suits your bathroom. You can order it using the set reference or by components reference (see technical information on page 265).



**Grupo de lavabo empotrado caño 16 cm**

Built-in wash-basin mixer with 16 cm pipe spout

● Ref.: 68131 08 45 66 - **Chrome**



**Grupo de lavabo empotrado caño 22 cm**

Built-in wash-basin mixer with 22cm pipe spout

● Ref.: 68132 08 45 66 - **Chrome**



**Grupo ducha empotrado 8"**

Built-in 8" shower mixer

● Ref.: 68115 08 45 66 - **Chrome**



**Grupo ducha empotrado 8" con inversor**

Built-in 8" bath mixer with diverter

● Ref.: 68116 08 45 66 - **Chrome**



**Inversor cerámico 3 vías empotrado placa redonda**

Built-in 3 way ceramic diverter with round plate

● Ref.: 63114 30 45 66 - **Chrome**



**Batería de baño con inversor**

Widespread bath mixer with diverter

● Ref.: 68113 08 45 66 - **Chrome**



**Batería de bidé con transmisión**

Widespread bidet mixer with transmission

● Ref.: 68142 08 45 66 - **Chrome**



**Llave de paso 1/2"**

Stopcock 1/2"

● Ref.: 68170 08 45 66 - **Chrome**





# Kalo

## Diseño modular para todos los estilos Modular design for all styles

**Genebre ha diseñado tres series de grifería bimando que combinan de forma perfecta y armoniosa los diferentes caños y volantes: Kalo, Kross e Ixo. Una propuesta muy versátil de formas sencillas y elegantes que permite múltiples combinaciones, únicas y personales..**

*Genebre has designed three series of dual-handle taps that perfectly and harmoniously combine these different spouts and handles: Kalo, Kross and Ixo. A versatile design with simple elegant forms which allow for multiple, personal and unique combinations.*

# Kalo



Chrome



Consulta las especificaciones técnicas de los productos escaneando el QR  
Check the technical specifications of the products by scanning the QR



**Batería de lavabo caño recto**  
Widespread wash-basin mixer with straight pipe spout

● Ref.: 68120 07 45 66 - **Chrome**



**Batería de lavabo caño cisne**  
Widespread wash-basin mixer with swan pipe spout

● Ref.: 68124 07 45 66 - **Chrome**



**Batería de lavabo caño inclinado**  
Widespread wash-basin mixer with sloping pipe spout

● Ref.: 68125 07 45 66 - **Chrome**



**Grupo de lavabo empotrado caño 16 cm**  
Built-in wash-basin mixer with 16 cm pipe spout

● Ref.: 68131 07 45 66 - **Chrome**



**Grupo de lavabo empotrado caño 22 cm**  
Built-in wash-basin with 22 cm pipe spout

● Ref.: 68132 07 45 66 - **Chrome**



**Grupo de Lavabo Empotrado**  
WBuilt-in Wash-basin Mixer

Ref.: 68137 07 45 66



Las series Kalo, Kross e Ixo nacen de la combinación de diferentes componentes: cuerpos, caños y volantes.  
Busque la combinación que mejor se adapte a su baño. Puede pedirla utilizando la referencia del catálogo (conjunto)  
o bien por referencia de cada uno de los componentes (ver información técnica en la página 264).

The series Kalo, Kross and Ixo are born from the combination of different components: bodies, pipes and handles.  
Look for the combination that best suits your bathroom. You can order it using the set reference or by components reference  
(see technical information on page 264).

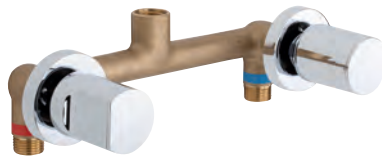

#### Grupo ducha empotrado 8"

Built-in 8" shower mixer

● Ref.: 68115 07 45 66 - **Chrome**



#### Grupo baño empotrado 8" con inversor

Built-in 8" bath mixer with diverter

● Ref.: 68116 07 45 66 - **Chrome**



#### Inversor cerámico 3 vías empotrado placa redonda

Built-in 3 way ceramic diverter with round plate

● Ref.: 63114 30 45 66 - **Chrome**



#### Batería de baño con inversor

Widespread bath mixer with diverter

● Ref.: 68113 07 45 66 - **Chrome**



#### Batería de bidé con transmisión

Widespread bidet mixer with transmission

● Ref.: 68142 07 45 66 - **Chrome**



#### Llave de paso 1/2"

Stopcock 1/2"

● Ref.: 68170 07 45 66 - **Chrome**





# Style shower

## Duchas con estilo / Showers with style

**Para que a la ducha no le falte de nada. Disponemos de una amplia gama de mangos de duchas, accesorios y complementos ideales para cada modelo. Una colección que convierte a cada pieza en una creación inteligente y totalmente flexible para un entorno de bienestar.**

*For the shower that has everything. We have a wide range of jet handshowers, accessories and complements ideal for each model. A collection that turns each piece in to an intelligent creation, totally flexible for an environment of well being.*

# Style shower



NEW



**Inversor cerámico 3 vías empotrado con placa cuadrada**  
Built-in 3-way ceramic diverter with square plate

● Ref.: 65114 30 45 66 - **Chrome**

**Monomando de ducha empotrado**  
Built-in single lever shower mixer

● Ref.: 65115 18 45 66 - **Chrome**

**Rociador doble función cascada-lluvia**  
Shower head double function waterfall-rain

● Ref.: 1643 45 - **Chrome**

**Toma ducha mural redonda**  
Round wall connector

● Ref.: 1680 04 - **Chrome**

**Conjunto Tau, barra, flexo y ducha 5 jets**  
Tau set, bar, hose and 5 jets handshower

● Ref.: 1748 45 - **Chrome**

**Monomando empotrado con inversor cerámico 3 vías**  
Built-in single lever mixer with 3-way ceramic diverter

● Ref.: 64118 32 45 66 - **Chrome**

**Rociador doble función cascada-lluvia**  
Shower head double function waterfall-rain

● Ref.: 1643 45 - **Chrome**

**Soporte de ducha cilíndrico con toma 1/2"**  
Cylindrical shower holder with 1/2" connector

● Ref.: 1634 04 - **Chrome**

**Flexo extensible 1,70 - 2,25 m inoxidable doble grapaje**  
Extensible stainless steel flexible hose 1,70 to 2,25 m double lock

● Ref.: 100137 60 00 - **Chrome**

**Mango de ducha T3 jets**  
T3 jets handshower

● Ref.: DXT3 45 - **Chrome**

**Grupo ducha empotrado 8" con inversor**  
Built-in 8" shower mixer with diverter

● Ref.: 68116 12 45 66 - **Chrome**

**Inversor cerámico 3 vías empotrado placa redonda**  
Built-in 3 way ceramic diverter with round plate

● Ref.: 63114 30 45 66 - **Chrome**

**Rociador doble función cascada-lluvia**  
Shower head double function waterfall-rain

● Ref.: 1643 45 - **Chrome**

**Soporte de ducha orientable cilíndrico con toma 1/2"**  
Orientable cylindrical shower holder with 1/2" connector

● Ref.: 1633 04 - **Chrome**

**Flexo extensible H 1/2" - H 1/2" 1,70 - 2,25 m inoxidable**  
F 1/2" - F 1/2" Extensible stainless steel flexible hose 1,70 to 2,25 m

● Ref.: 100137 60 00 - **Chrome**

**Mango de ducha T3 jets**  
T3 jets handshower

● Ref.: DXT3 45 - **Chrome**

**Caño mural baño cilíndrico**  
Round wall bath spout

● Ref.: 1668 45 - **Chrome**





**Ejemplos de combinaciones\*  
para todos los espacios y necesidades.**

*Examples of combinations\* for all kind of  
spaces and needs.*

*\* En cada combinación hay un conjunto de  
referencias que han de ser solicitadas para  
obtener su conjunto.*

*\* In each combination there is a set of references  
that have to be requested to obtain their set.*



NEW

**Monomando empotrado con inversor cerámico 2 vías**  
Built-in single lever mixer with 2-way ceramic diverter

● Ref.: 64117 32 45 66 - **Chrome**

**Brazo pared redondo 35 cm**  
Round wall arm 35 cm

● Ref.: B65113 18 - **Chrome**

**Rociador D22 ovalado**  
Oval D22 shower sprayer

● Ref.: R63112 08 - **Chrome**

**Soporte de ducha cilíndrico con toma 1/2"**  
Cylindrical shower holder with 1/2" connector

● Ref.: 1634 04 - **Chrome**

**Flexo extensible 1,70 - 2,25 m inoxidable doble grapaje**  
**Extensible stainless steel flexible hose 1,70 to 2,25 m double lock**

● Ref.: 100137 60 00 - **Chrome**

**Mango de ducha T3 jets**  
T3 jets handshower

● Ref.: DXT3 45 - **Chrome**

**Monomando empotrado con inversor cerámico 3 vías**  
Built-in single lever mixer with 3-way ceramic diverter

● Ref.: 65118 18 45 66 - **Chrome**

**Brazo pared redondo 35 cm**  
Round wall arm 35 cm

● Ref.: B65113 18 - **Chrome**

**Rociador redondo 22 cm**  
Round shower head Ø 22 cm

● Ref.: R65112 18 - **Chrome**

**Toma ducha mural redonda**  
Round wall connector

● Ref.: 1680 04 - **Chrome**

**Conjunto Tau, barra, flexo y ducha 5 jets**  
Tau set, bar, hose and 5 jets handshower

● Ref.: 1748 45 - **Chrome**

**Caño mural baño cilíndrico**  
Round wall bath spout

● Ref.: 1668 45 - **Chrome**

**Monomando empotrado con inversor 2 vías**  
2 way Built-in single lever mixer with diverter

● Ref.: 64116 16 45 66 - **Chrome**

**Brazo pared redondo 35 cm**  
Round wall arm 35 cm

● Ref.: B65113 18 - **Chrome**

**Rociador redondo 22 cm**  
Round shower head Ø 22 cm

● Ref.: R65112 18 - **Chrome**

**Caño mural baño cilíndrico**  
Round wall bath spout

● Ref.: 1668 45 - **Chrome**





**Monomando empotrado con inversor 2 vías**  
2 way Built-in single lever mixer with diverter

● Ref.: 63116 26 45 66 - **Chrome**

**Brazo pared cuadrado 35 cm**  
Square wall arm 35 cm

● Ref.: B63113 26 - **Chrome**

**Rociador cuadrado 22 cm**  
Square shower head 22 cm

● Ref.: R63112 26 - **Chrome**

**Caño mural baño cuadrado**  
Square wall bath spout

● Ref.: 1674 45 - **Chrome**





**Monomando de baño sin kit**

Single lever bath mixer without kit

● Ref.: 63100 26 45 67 - **Chrome**

**Set columna con ducha, soporte y flexo**

Column set with shower, holder and flexible hose

● Ref.: 1746 45 - **Chrome**



**Termostática ducha sin kit**

Thermostatic shower mixer without kit

● Ref.: 67110 26 45 67 - **Chrome**

**Set columna con ducha, soporte y flexo**

Column set with shower, holder and flexible hose

● Ref.: 1746 45 - **Chrome**



**Consulte la ficha técnica de nuestros productos: Para encontrar toda la información técnica de cualquier producto, localice la referencia del artículo al final de este catálogo, o en nuestra web.**

Consult data sheet of our products: Use the item reference to find all of the technical information on any of our products, at the end of this catalogue or our web.







**Set Columna con Ducha, Soporte y Flexo**  
Column Set with Shower, Holder and Flexible Hose



**Grupo ducha empotrado 8"**  
Built-in 8" shower mixer

● Ref.: 68115 08 45 66 - **Chrome**

**Toma ducha mural redonda**  
Round wall connector

● Ref.: 1680 04 - **Chrome**

**Set columna con ducha, soporte y flexo**  
Column set with shower, holder and flexible hose

● Ref.: 1745 45 - **Chrome**



**Monomando de ducha empotrado**  
Built-in single lever shower mixer

● Ref.: 64115 16 45 66 - **Chrome**

**Toma ducha mural redonda**  
Round wall connector

● Ref.: 1680 04 - **Chrome**

**Set columna con ducha, soporte y flexo**  
Column set with shower, holder and flexible hose

● Ref.: 1745 45 - **Chrome**



**Monomando empotrado con inversor cerámico 3 vías**  
Built-in single handle mixer with 3-way ceramic diverter

● Ref.: 64118 04 45 66 - **Chrome**

**Brazo a techo redondo 15 cm**  
Round roof arm 15 cm

● Ref.: 1671 45 - **Chrome**

**Rociador redondo 22 cm**  
Round shower head Ø 22 cm

● Ref.: R65112 18 - **Chrome**

**Toma ducha mural redonda**  
Round wall connector

● Ref.: 1680 04 - **Chrome**

**Barra ducha metálica**  
Metallic shower bar

● Ref.: 1639 45 - **Chrome**

**Flexo H 1/2" - H 1/2" 1,70 m. PVC antirrotura**  
F 1/2" - F 1/2" PVC flexible hose 1.70 m anti-breaking

● Ref.: 100140 30 - **Chrome**

**Mango de ducha T3 jets**  
T3 jets handshower

● Ref.: DXT3 45 - **Chrome**

**Caño mural baño cilíndrico**  
Round wall bath spout

● Ref.: 1668 45 - **Chrome**





**Set Columna con Ducha, Soporte y Flexo**  
Column Set with Shower, Holder and Flexible Hose



**Monomando empotrado con inversor 2 vías**  
2 way Built-in single lever mixer with diverter

● Ref.: 63116 26 45 66 - **Chrome**

**Brazo a techo cuadrado 15 cm**  
Square roof arm 15 cm

● Ref.: 1672 45 - **Chrome**

**Rociador cuadrado 22 cm**  
Square shower head 22 cm

● Ref.: R63112 26 - **Chrome**

**Toma ducha mural cuadrada**  
Square wall connector

● Ref.: 1679 04 - **Chrome**

**Conjunto Kenjo, barra, flexo y ducha 3 jets**  
Kenjo set, bar, flexible hose and 3 jets handshower

● Ref.: 1747 45 - **Chrome**

**Monomando empotrado con inversor cerámico 2 vías**  
Built-in single lever mixer with 2 way ceramic diverter

● Ref.: 62117 31 45 66 - **Chrome**

**Brazo a techo redondo 15 cm**  
Round roof arm 15 cm

● Ref.: 1671 45 - **Chrome**

**Rociador ovalado 22 cm**  
Oval shower head 22 cm

● Ref.: R65112 08 - **Chrome**

**Soporte de ducha orientable cilíndrico con toma 1/2"**  
Orientable cylindrical shower holder with 1/2" connector

● Ref.: 1633 04 - **Chrome**

**Flexo extensible H 1/2" - H 1/2" 1,70 - 2,25 m inoxidable**  
F 1/2" - F 1/2" Extensible stainless steel flexible hose 1.70 to 2.25 m

● Ref.: 100137 60 00 - **Chrome**

**Mango de ducha O3 jets**  
O3 jets handshower

● Ref.: DXO3 45 - **Chrome**

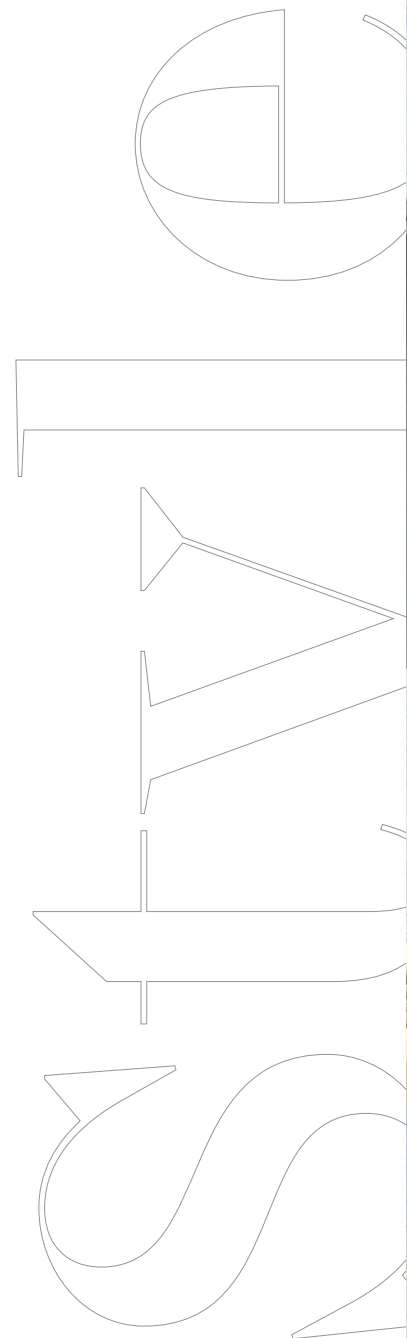





**Monomando Empotrado con Inversor Cerámico 2 Vías**  
Built-in Single Lever Mixer with 2 Way Ceramic Diverter

# Grifería empotrada para ducha con sistema GEBOX

## Built-in shower taps with GEBOX system

Con el sistema GEBOX de Genebre, ahora la instalación de grifería empotrada para ducha resulta más sencilla, ágil y segura. Gracias a su sistema premontado de cuerpo preinstalado en caja permite una instalación rápida y sencilla. Disponible tanto para monomandos de una vía, como también para monomandos de dos o tres vías. Además, cuenta con un gran abanico de acabados, lo que le otorga gran versatilidad al sistema modular para grifería empotrada, que permite combinar elementos para que se adapten perfectamente a cualquier espacio de baño.

*With the GEBOX system from Genebre, the installation of built-in shower taps is now easier, more agile and safer. Thanks to its pre-assembled system with a pre-installed body in a box, it allows for quick and easy installation. Available for both one-way single-lever and also two- or three-way single-lever. In addition, it has a wide range of finishes, which gives great versatility to the modular system for built-in taps, allowing elements to be combined so that they adapt perfectly to any bathroom space.*



**¡Enlaza al video y conoce mejor nuestro sistema GEBOX!**

*Link to the video and learn about our GEBOX system!*

**Monomando empotrado premontado sistema GEBOX**  
GEBOX system pre-assembled built-in single lever mixer

**1 vía**  
1 way



B115 40 45



**Kits Placa ducha empotrada**  
*Built-in shower mixer plate Kits*



KPB115 40 45



KPC115 40 45



KPT115 40 45



**Manetas**  
*Levers*



100001 18 45



100001 22 45

**Kits Placa ducha empotrada Negro**  
*Black Built-in shower mixer plate Kit*



KPC115 40 41



**Monomando empotrado premontado sistema GEBOX**  
 GEBOX system pre-assembled built-in single lever mixer

**2 vías**  
 2 ways



B117 40 45



KPB117 40 45



KPC117 40 45



KPT117 40 45



100001 28 45



100001 29 45

**Monomando empotrado premontado sistema GEBOX**  
 GEBOX system pre-assembled built-in single lever mixer

**3 vías**  
 3 ways



B118 40 45



KPB118 40 45



KPC118 40 45



KPT118 40 45



100001 31 45



100001 32 45



KPC117 40 41



KPC118 40 41

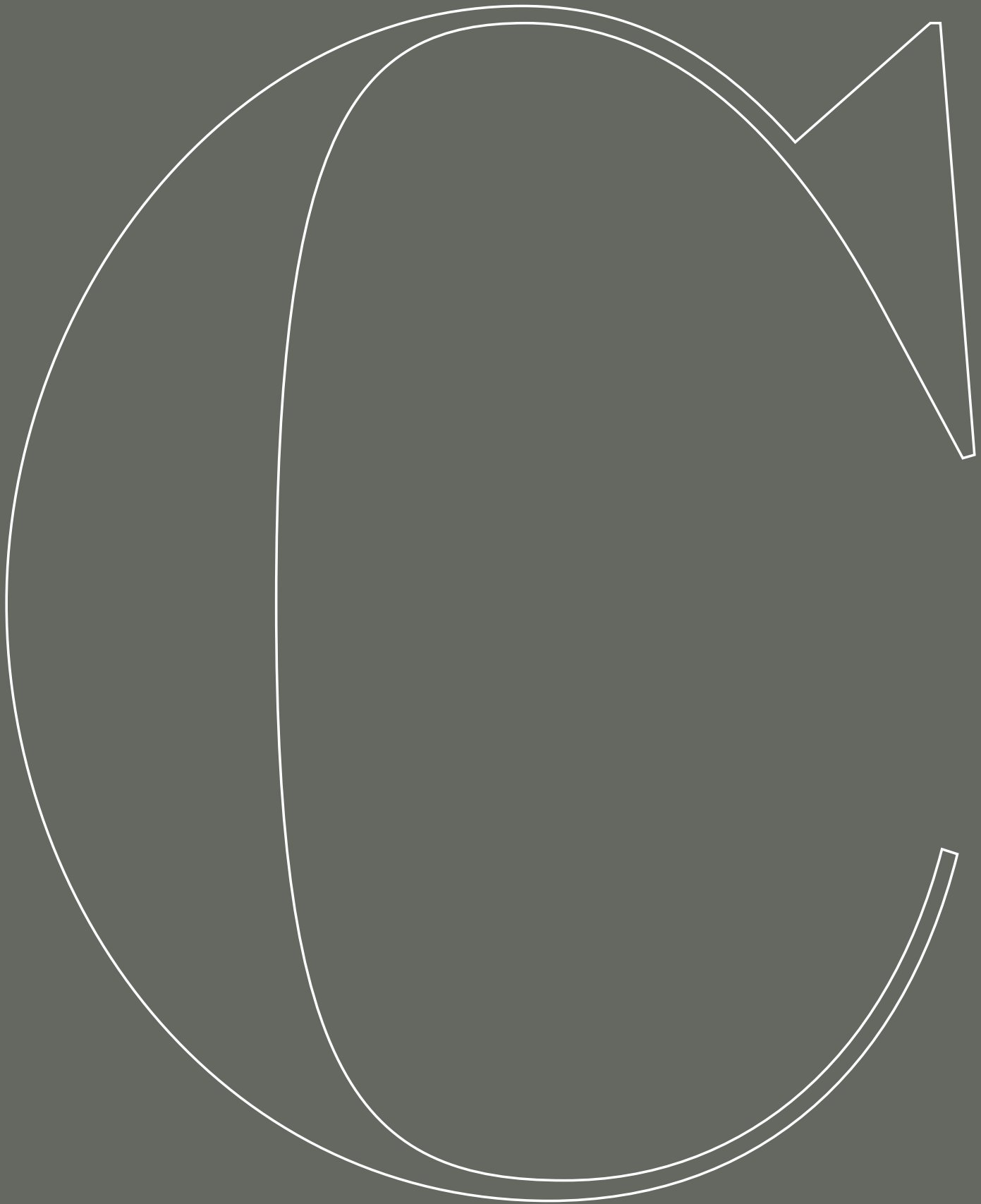



# Cocina

## Kitchen

**El agua es vida. Sólo con verla y oírla, aumenta el flujo sanguíneo en el cerebro y el corazón, y nos relaja.**

**En Genebre sabemos la gran variedad de beneficios que sólo el agua puede ofrecer. Por eso seguimos mejorando continuamente nuestros productos para que tu experiencia con el agua sea cada día mejor. Esa es nuestra razón de ser y lo que en realidad mejor sabemos hacer.**

*Water is life. Just seeing and hearing it increases the blood flow in the brain and heart, and relaxes us.*

*At Genebre, we know the great variety of benefits that only water can offer. That's why we continue improving our products so that your experience with water is better every day. That is our reason for being and what we really know best how to do.*

# Grifería de cocina para encimeras

## Countertop sink mixers

Cartucho **Ø40** Cartridge



**Monomando de fregadera KORAL**  
KORAL Single lever sink mixer  
● Ref.: 64201 32 45 66 - **Chrome**



**Monomando de fregadera KLIP**  
KLIP Single lever sink mixer  
● Ref.: 64201 16 45 66 - **Chrome**



**Monomando de fregadera apertura frío KELOGIC**  
KELOGIC Single lever sink mixer cold start  
● Ref.: 64201 04 45 66 - **Chrome**



**Monomando de fregadera cartucho 40 TAU**  
TAU Single lever sink mixer 40 cartridge  
● Ref.: 65214 18 45 66 - **Chrome**



**Monomando de fregadera cartucho 40 TAU**  
TAU Single lever sink mixer 40 cartridge  
● Ref.: 65204 18 45 66 - **Chrome**



**Monomando de fregadera cartucho 40 TAU**  
TAU Single lever sink mixer 40 cartridge  
● Ref.: 65203 18 45 66 - **Chrome**



Cartucho **Ø40** Cartridge



**Monomando de fregadera caño fundido K8**

K8 Single lever sink mixer casted spout

● Ref.: 61201 28 45 66 - **Chrome**



**Monomando de fregadera caño conformado K8**

K8 Single-lever sink mixer tube spout

● Ref.: 61203 28 45 66 - **Chrome**



**Monomando de fregadera caño conformado K8**

K8 Single-lever sink mixer tube spout

● Ref.: 61204 28 45 66 - **Chrome**



**Monomando de fregadera caño fundido K8**

K8 Single lever sink mixer casted spout

● Ref.: 61210 28 45 66 - **Chrome**



**Monomando de fregadera K8**

K8 Single lever sink mixer

● Ref.: 61200 28 45 66 - **Chrome**

# Grifería de cocina para encimeras

## Countertop sink mixers



Consulta las especificaciones técnicas de los productos escaneando el QR  
Check the technical specifications of the products by scanning the QR



Cartucho  $\varnothing 35$  Cartridge



**Monomando de fregadera OSLO**  
OSLO Single lever sink mixer

● Ref.: 65200 19 45 66 - **Chrome**



**Monomando de fregadera apertura en frío OSLO**  
OSLO Single lever sink mixer cold start

● Ref.: 65203 19 45 66 - **Chrome**



**Monomando de fregadera cartucho 35 apertura en frío TAU**  
TAU Single lever sink mixer 35 cartridge cold start

Ref.: FRT65402



**Monomando de fregadera cartucho 35 apertura en frío TAU**  
TAU Single lever sink mixer 35 cartridge cold start

● Ref.: 65404 18 45 66 - **Chrome**

Cartucho  $\varnothing$ 25 Cartridge



**Monomando de fregadera cartucho 25  
apertura en frío TAU**

TAU Single lever sink mixer 25 cartridge  
cold start

- Ref.: 65403 18 45 66 - **Chrome**
- Ref.: 65403 18 41 66 - **Black**
- Ref.: 65403 18 40 66 - **White**
- Ref.: 65403 18 44 66 - **Inox**



Monomando de Fregadera  
Single Lever Sink Mixer

Ref.: 65403 18 40 66



**Monomando de fregadera cartucho 25  
apertura en frío TAU**

TAU Single lever sink mixer 25 cartridge  
cold start

- Ref.: 65215 18 45 66 - **Chrome**



**Monomando de fregadera cartucho 25  
apertura en frío TAU**

TAU Single lever sink mixer 25 cartridge  
cold start

Ref.: FRT65401



Monomando de Fregadera  
Single Lever Sink Mixer



Ref.: FRK63400



## Grifería de cocina para encimeras / Countertop sink mixers

Cartucho **Ø25** Cartridge



**Monomando de fregadera cartucho 25  
apertura en frío TAU**

TAU Single lever sink mixer 25 cartridge  
cold start

● Ref.: 65219 18 45 66 - **Chrome**



**Monomando de fregadera  
cartucho 25 KENJO**

KENJO Single lever sink mixer 25 cartridge  
Ref.: FRK63400



**Monomando de fregadera cartucho 25 KENJO**

KENJO Single lever sink mixer 25 cartridge

● Ref.: FRK63401 - **Chrome**



**Monomando mesada 8"**

8" widespread single lever sink mixer

● Ref.: 60198 05 45 66 - **Chrome**



**Monomando mesada 16cm**

16cm widespread single lever sink mixer

● Ref.: 60199 05 45 66 - **Chrome**

# Tu manantial de agua pura y sana

## Your own source of pure and healthy water

**El nuevo sistema de ultrafiltración GENE BRE purifica el agua conservando todos los minerales y propiedades beneficiosas para la salud.**

En el proceso de ultrafiltración participan un primer cartucho compuesto de carbón activo de clorador, para el filtrado y retención de olores y sabores, cloro libre, compuestos orgánicos, trihalometanos y DQO. El cartucho verde es de ultra filtración anti bacteriológico con una efectividad superior al 99% la eliminación de E. Coli, bacterias coliformes y aerobios totales.

*The new GENE BRE ultrafiltration anti system purifies water conserving all the minerals and properties that are beneficial to your health.*

*The ultrafiltration process involves a first cartridge composed of dechlorinating active carbon, to filter and retain odours and flavours, free chlorine, organic compounds, trihalomethanes and COD. The green cartridge offers anti-bacteriological ultrafiltration, which is more than 99% effective at eliminating E. coli, coliform and total aerobic bacteria.*

### **Carbón activo de clorador** Dechlorinator activated carbon

**El filtro azul elimina olores y malos sabores dejando el agua pura.**

The blue filter eliminates odours and bad tastes leaving pure water.

### **Filtración anti bacteriológica** Anti-bacteriological filtration

**El cartucho verde realiza una ultrafiltración anti bacteriológica con una efectividad superior al 99%, para un agua sana.**

The green cartridge performs anti-bacteriological ultrafiltration, with more than 99% effectiveness, for healthy water.





# Grifería de cocina para filtrado

## Sink mixers for filtration



Consulta las especificaciones técnicas de los productos escaneando el QR  
Check the technical specifications of the products by scanning the QR



NEW

### Monomando de fregadera 3 vías apertura en frío TAU

TAU Single lever 3-way sink mixer cold start

- Ref.: 65702 18 45 66 - **Chrome**
- Ref.: 65702 18 41 66 - **Black**
- Ref.: 65702 18 44 66 - **Inox**



### Grifo de 1 vía TAU

TAU One way tap

- Ref.: 65700 18 45 66 - **Chrome**



Monomando de Fregadera  
Single Lever Sink Mixer

Ref.: 65702 18 41 66



**Kit declorador**  
Dechlorinator kit  
Ref.: FT00



NEW

**Kit ultrafiltración**  
Ultrafiltration kit  
Ref.: FT01



NEW

**Filtro declorador**  
Dechlorinator filter  
Ref.: FT92



NEW

**Filtro ultrafiltración**  
Ultrafiltration filter  
Ref.: FT91



Monomando de Fregadera  
Single Lever Sink Mixer



Ref.: FRV61208 44

# Grifería de cocina extraíble

## Pull out sink mixers



Consulta las especificaciones técnicas de los productos escaneando el QR  
Check the technical specifications of the products by scanning the QR



Cartucho  $\varnothing 25$  Cartridge



### Monomando de fregadera Inox caño extraíble TAU

TAU Stainless steel Single-lever sink mixer with pull-out spout

- Ref.: FRV61208 44 - **Inox**
- Ref.: FRV61208 41 - **Black**
- Ref.: FRV61208 45 - **Chrome**

Cartucho  $\varnothing 35$  Cartridge



### Monomando de fregadera Inox caño extraíble TAU

TAU Stainless steel Single-lever sink mixer with pull-out spout

- Ref.: FRV61206 - **Chrome**
- Ref.: FRV61207 44 - **Inox**
- Ref.: FRV61207 40 - **White**
- Ref.: FRV61207 41 - **Black**



## Grifería de cocina extraíble / Pull out sink mixers

Cartucho Ø40 Cartridge



**Monomando de fregadera ducha extraíble**  
Single lever sink mixer with pull-out spray

● Ref.: 65205 18 45 66 - **Chrome**



**Monomando de fregadera caño extraíble TAU**  
TAU Single lever sink mixer with pull-out spout

● Ref.: 65206 18 45 66 - **Chrome**



**Monomando de fregadera ducha extraíble TAU**

TAU Single lever sink mixer with pull-out spray

● Ref.: FRV61205 - **Chrome**



**Monomando de fregadera ducha extraíble KORAL**  
KORAL Single lever sink mixer with pull-out spray

● Ref.: 64206 32 45 66 - **Chrome**



**Monomando de fregadera ducha extraíble KLIP**  
KLIP Single lever sink mixer with pull-out spray

● Ref.: 64206 16 45 66 - **Chrome**



**Monomando de fregadera ducha extraíble K8**

K8 Single-lever sink mixer with pull-out spray

● Ref.: 61206 28 45 66 - **Chrome**



**Monomando de fregadera ducha extraíble K8**  
K8 Single lever sink mixer with pull-out spray

● Ref.: 61205 28 45 66 - **Chrome**



**Monomando de Fregadera**  
Single Lever Sink Mixer

Ref.: FRV61205



Monomando de Fregadera  
Single Lever Sink Mixer

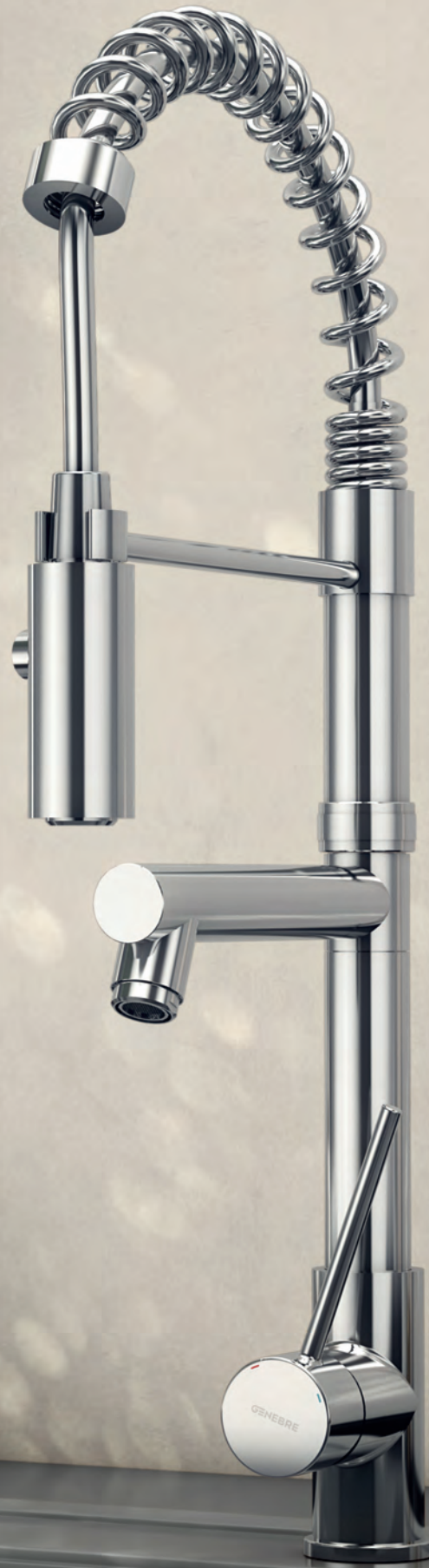



# Grifería de cocina con muelle

## Sink mixers with spring

Cartucho  $\varnothing 35$  Cartridge



### Monomando de fregadera inox con muelle y ducha extraíble TAU

TAU Stainless steel single lever sink mixer with spring and pull-out sprayer

● Ref.: 65207 18 60 66 - **Inox**



### Monomando de fregadera inox con muelle TAU

TAU Stainless steel single lever sink mixer with spring

● Ref.: 65211 18 60 66 - **Inox**



Consulta las especificaciones técnicas de los productos escaneando el QR  
Check the technical specifications of the products by scanning the QR



### Monomando de fregadera con muelle TAU

TAU Single lever sink mixer with spring

● Ref.: 65211 18 45 66 - **Chrome**



### Monomando de fregadera con muelle y caño TAU

TAU Single lever sink mixer with spring and spout

● Ref.: 65212 18 45 66 - **Chrome**

# Grifería de cocina mural

## Wall-mounted sink mixers



Consulta las especificaciones técnicas de los productos escaneando el QR  
Check the technical specifications of the products by scanning the QR



Cartucho  $\varnothing$ 40 Cartridge



**Monomando de fregadera mural KORAL**  
KORAL Wall single lever sink mixer

● Ref.: 64192 32 45 66 - **Chrome**



**Monomando de fregadera mural KLIP**  
KLIP Wall single lever sink mixer

● Ref.: 64192 16 45 66 - **Chrome**



**Monomando de fregadera mural 15 cm TAU**  
TAU Wall single lever sink mixer 15 cm

● Ref.: 65192 18 45 66 - **Chrome**



**Monomando de fregadera mural 11 cm**  
Wall single lever sink mixer 11 cm

● Ref.: 61195 28 45 66 - **Chrome**



**Monomando de fregadera caño inferior elevado K8**  
K8 Wall single lever sink mixer low spout

● Ref.: 61196 28 45 66 - **Chrome**



Cartucho **Ø40** Cartridge



**Monomando de fregadera mural 15 cm, caño corto**  
Wall single lever sink mixer 15 cm, short spout

● Ref.: 61190 28 45 66 - **Chrome**



**Monomando de fregadera mural 15 cm, caño largo**  
Wall single-lever sink mixer 15 cm, long spout

● Ref.: 61192 28 45 66 - **Chrome**

Cartucho **Ø35** Cartridge



**Monomando de fregadera mural 15 cm OSLO**  
OSLO Wall single lever sink mixer 15 cm

● Ref.: 65192 19 45 66 - **Chrome**



**Monomando de fregadera mural 8"**  
Wall single lever 8" sink mixer

● Ref.: 60194 05 45 66 - **Chrome**



La grifería GENE BRE está diseñada y fabricada según los estándares europeos de calidad, como la UNE-EN 19703 ofreciendo la funcionalidad, durabilidad y seguridad esperadas.

GENEBRE taps are designed and manufactured according to European quality standards, such as UNE-EN 19703, offering the expected functionality, durability and safety.



**Monomando de Fregadera Mural**  
Wall Single Lever Sink Mixer

Ref.: 61190 28 45 66

# Grifería de cocina abatible

## Folding sink mixers



Consulta las especificaciones técnicas de los productos escaneando el QR  
Check the technical specifications of the products by scanning the QR



Cartucho  $\varnothing$ 35 Cartridge



**Monomando de fregadera abatible cartucho 35 apertura en frío TAU**  
TAU Single lever folding sink mixer 35 cartridge cold start

● Ref.: 65900 18 45 66 - **Chrome**

Cartucho  $\varnothing$ 40 Cartridge



**Monomando de fregadera abatible K8**  
K8 Single lever folding sink mixer

● Ref.: 61900 28 45 66 - **Chrome**



# Grifería de cocina selección Inox

## Stainless steel selection sink mixers



Consulta las especificaciones técnicas de los productos escaneando el QR  
Check the technical specifications of the products by scanning the QR



### Beneficios del acero inoxidable en la cocina:

La serie Inox está diseñada especialmente para el mundo de la cocina, su material es ideal para cubrir todas las garantías de higiene y sanitarias y resultan más inalterables al uso.

### Benefits of stainless steel in the kitchen:

The Inox series is specially designed for the kitchen world, its material is ideal to cover all hygiene and sanitary guarantees and is more unalterable when used.



Ref.: 65219 40 60 66

### Cartucho Ø35 Cartridge



#### Monomando de fregadera inox caño cisne TAU

TAU Stainless steel single lever sink mixer with swan pipe

● Ref.: 65203 18 60 66 - **Inox**



#### Monomando de fregadera inox con muelle TAU

TAU Stainless steel single lever sink mixer with spring

● Ref.: 65211 18 60 66 - **Inox**



#### Monomando de fregadera inox con muelle y ducha extraíble TAU

TAU Stainless steel single lever sink mixer with spring and pull-out sprayer

● Ref.: 65207 18 60 66 - **Inox**



## Grifería de cocina selección Inox / Stainless steel selection sink mixers

Cartucho Ø25 Cartridge



**Monomando de fregadera inox cartucho 25**

Stainless steel single lever sink mixer  
25 cartridge

● Ref.: 65215 40 60 66 - **Inox**



**Monomando de fregadera inox cartucho 25**

**TAU 2**  
TAU 2 Stainless steel single lever sink mixer  
25 cartridge

● Ref.: 65219 40 60 66 - **Inox**





**Monomando de Fregadera Inox**  
Stainless Steel Single Lever Sink Mixer

Ref.: 65215 40 60 66

# Grifería de cocina Classic

## Classic sink mixers

Encimeras Countertop

### New Regent

Cartucho Ø40 Cartridge



Consulta las especificaciones técnicas de los productos escaneando el QR  
Check the technical specifications of the products by scanning the QR



**Monomando de fregadera NEW REGENT**  
NEW REGENT sink mixer  
● Ref.: 68201 39 43 66 - **Bronze**



**Monomando de fregadera NEW REGENT**  
NEW REGENT sink mixer  
● Ref.: 68201 39 45 66 - **Chrome**

Montura cerámica Ceramic frame



**Monobloc de fregadera NEW REGENT**  
NEW REGENT sink mixer  
● Ref.: 68595 09 43 66 - **Bronze**



**Monobloc de fregadera NEW REGENT**  
NEW REGENT sink mixer  
● Ref.: 68595 09 45 66 - **Chrome**



**Monomando de Fregadera**  
Single Lever Sink Mixer



## Grifería de cocina Classic / Classic sink mixers

Encimeras Countertop

### New Regent

Montura cerámica Ceramic frame



---

**Monobloc fregadera caño tubo**  
**NEW REGENT**  
NEW REGENT Sink mixer, swan neck spout  
● Ref.: 68540 09 45 66 - **Chrome**



---

**Grifo fregadera encimera caño tubo vertical**  
**NEW REGENT**  
NEW REGENT Deck sink tap  
with swan neck spout  
● Ref.: 68585 09 45 66 - **Chrome**



---

**Mezclador mesada 8" caño tubo**  
**NEW REGENT**  
NEW REGENT 8" deck mixer  
with swan neck spout  
● Ref.: 68545 09 45 66 - **Chrome**



---

**Mezclador mesada 16 cm caño tubo**  
**NEW REGENT**  
NEW REGENT 16 cm deck mixer  
with swan neck spout  
● Ref.: 68194 09 45 66 - **Chrome**

## Gamma

Montura cerámica Ceramic frame



### Monobloc de fregadera caño tubo GAMMA

GAMMA Sink mixer, swan neck spout

● Ref.: 68200 11 45 66 - **Chrome**



### Mezclador mesada 6" caño tubo GAMMA

GAMMA 6" deck mixer with swan neck spout

● Ref.: 68194 11 45 66 - **Chrome**



### Mezclador mesada 8" caño tubo GAMMA

GAMMA 8" deck mixer with swan neck spout

● Ref.: 68199 11 45 66 - **Chrome**



### Grifo fregadera encimera caño tubo vertical GAMMA

GAMMA Deck sink tap with swan neck spout

● Ref.: 68003 11 45 66 - **Chrome**





## Grifería de cocina Classic / Classic sink mixers

Mural Wall

### New Regent

Montura cerámica Ceramic frame



**Grupo mural fregadera 15 cm caño tubo alto 24 cm NEW REGENT**  
NEW REGENT Wall sink mixer with 15 cm with high tube, 24 cm spout

● Ref.: 68555 09 45 66 - **Chrome**



**Grupo mural fregadera 15 cm caño tubo bajo 24 cm NEW REGENT**  
NEW REGENT Wall sink mixer with 15cm low tube, 24 cm spout

● Ref.: 68560 09 45 66 - **Chrome**



**Grupo mural fregadera 11 cm caño tubo alto 24 cm NEW REGENT**  
NEW REGENT Wall sink mixer with 11cm high tube, 24 cm spout

● Ref.: 68196 09 45 66 - **Chrome**



**Grupo mural fregadera 11 cm caño tubo alto 18 cm NEW REGENT**  
NEW REGENT Wall sink mixer with 11 cm high tube, 18 cm spout

● Ref.: 68550 09 45 66 - **Chrome**



**Grupo mural fregadera 20 cm caño tubo alto 24 cm NEW REGENT**  
NEW REGENT 20 cm wall sink mixer with high tube, 24 cm spout

● Ref.: 68565 09 45 66 - **Chrome**



**Grupo mural fregadera 20 cm caño tubo alto vertical NEW REGENT**  
NEW REGENT 20 cm wall sink mixer with swan neck spout

● Ref.: 68570 09 45 66 - **Chrome**

# Classico



**Grifo mural fregadera caño tubo alto 24 cm NEW REGENT**

NEW REGENT Wall sink tap with tube spout 24 cm

● Ref.: 68580 09 45 66 - **Chrome**



**Grifo fregadera mural caño tubo vertical NEW REGENT**

NEW REGENT Wall sink tap with swan neck spout

● Ref.: 68575 09 45 66 - **Chrome**



La grifería GENE BRE está diseñada y fabricada según los estándares europeos de calidad, como la UNE-EN 19703 ofreciendo la funcionalidad, durabilidad y seguridad esperadas.

GENEBRE taps are designed and manufactured according to European quality standards, such as UNE-EN 19703, offering the expected functionality, durability and safety.

## Grifería de cocina Classic / Classic sink mixers

Mural Wall

### New Regent

Montura cerámica Ceramic frame



**Cuerpo grupo mural 20 cm NEW REGENT**  
NEW REGENT Wall body mixer 20 cm  
Ref.: 568565 45



**Cuerpo grupo mural 15 cm NEW REGENT**  
NEW REGENT Wall body mixer 15 cm  
Ref.: 568555 45



**Cuerpo grupo mural 11 cm NEW REGENT**  
NEW REGENT Wall body mixer 11 cm  
Ref.: 568550 45



**Cuerpo grifo mural NEW REGENT**  
NEW REGENT Wall body tap  
Ref.: 568575 45



**Caño alto tubo 18 cm**  
High pipe spout 18 cm  
Ref.: 68901 45

**Caño alto tubo 24 cm**  
High pipe spout 24 cm  
Ref.: 68902 45

**Caño alto tubo 30 cm**  
High tube spout 30 cm  
Ref.: 68908 45



**Caño tubo vertical**  
Vertical pipe spout  
Ref.: 68903 45



**Caño bajo tubo 18 cm**  
Low tube spout 18 cm  
Ref.: 68910 45

**Caño bajo tubo 24 cm**  
Low tube spout 24 cm  
Ref.: 68904 45

**Caño bajo tubo 30 cm**  
Low tube spout 30 cm  
Ref.: 68909 45



## Grifería de cocina Classic / Classic sink mixers

Mural Wall

### Gamma

Montura convencional Conventional frame



**Grupo mural fregadera 15 cm caño tubo alto 24 cm GAMMA**

GAMMA Wall sink mixer with 15 cm with high tube, 24 cm spout

● Ref.: 68193 11 45 66 - **Chrome**



**Grupo mural fregadera 15 cm caño tubo bajo 24 cm GAMMA**

GAMMA Wall sink mixer with 15cm low tube, 24 cm spout

● Ref.: 68197 11 45 66 - **Chrome**



**Grupo mural fregadera 11 cm caño tubo alto 24 cm GAMMA**

GAMMA Wall sink mixer with 11 cm, high tube 24 cm spout

● Ref.: 68196 11 45 66 - **Chrome**



**Grupo mural fregadera 11 cm caño tubo alto 18 cm GAMMA**

GAMMA Wall sink mixer with 11cm high tube, 18 cm spout

● Ref.: 68195 11 45 66 - **Chrome**



**Grupo mural fregadera 20 cm caño tubo alto 24 cm GAMMA**

GAMMA 20 cm wall sink mixer with high tube, 24 cm spout

● Ref.: 68104 11 45 66 - **Chrome**



**Grupo mural fregadera 20 cm caño tubo alto vertical GAMMA**

GAMMA 20 cm wall sink mixer with swan neck spout

● Ref.: 68103 11 45 66 - **Chrome**

## Grifería de cocina Classic / Classic sink mixers

Mural Wall

### Gamma

Montura convencional Conventional frame



**Grupo mural fregadera 15 cm caño tubo alto 18 cm GAMMA**

GAMMA Wall sink mixer with 15 cm, high tube, 18 cm spout

● Ref.: 68190 11 45 66 - **Chrome**



**Grifo mural fregadera caño tubo alto 24 cm GAMMA**

GAMMA Wall sink tap with tube spout 24 cm

● Ref.: 68093 11 45 66 - **Chrome**



**Grifo fregadera mural caño tubo vertical GAMMA**

GAMMA Wall sink tap with swan neck spout

● Ref.: 68083 11 45 66 - **Chrome**

# Classic

**Cuerpo grupo mural 20 cm GAMMA**

GAMMA Wall body mixer 20 cm

Ref.: 568104 45

**Cuerpo grupo mural 15 cm GAMMA**

GAMMA Wall body mixer 15 cm

Ref.: 568193 45

**Cuerpo grupo mural 11 cm GAMMA**

GAMMA Wall body mixer 11 cm

Ref.: 568195 45

**Cuerpo grifo mural GAMMA**

GAMMA Wall body tap

Ref.: 568083 45

**Caño alto tubo 18 cm**

High pipe spout 18 cm

Ref.: 68901 45

**Caño alto tubo 24 cm**

High pipe spout 24 cm

Ref.: 68902 45

**Caño alto tubo 30 cm**

High tube spout 30 cm

Ref.: 68908 45

**Caño tubo vertical**

Vertical pipe spout

Ref.: 68903 45

**Caño bajo tubo 18 cm**

Low tube spout 18 cm

Ref.: 68910 45

**Caño bajo tubo 24 cm**

Low tube spout 24 cm

Ref.: 68904 45

**Caño bajo tubo 30 cm**

Low tube spout 30 cm

Ref.: 68909 45



# Grifería de cocina de 1 agua

## One-tap sink taps



Consulta las especificaciones técnicas de los productos escaneando el QR  
Check the technical specifications of the products by scanning the QR



**Grifo mural con tubo 24 cm 1 agua cartucho 25**  
One-water wall sink tap spout 24 cm 25 cartridge  
Ref.: 1008 04



**Grifo fregadera 1 agua cartucho 25**  
One-water sink tap 25 cartridge  
Ref.: 1009 04



**Grifo mural con tubo alto 1 agua cartucho 25**  
One-water wall sink tap high spout 25 cartridge  
Ref.: 1005 04



**Grifo doble combinable a 1/2"- 3/4" y Aireador**  
Double outlet tap 1/2" - 3/4" and aerator  
Ref.: 1024 04



**Grifo doble combinable 1/2"-3/4" y 1/2"**  
Double outlet tap 1/2"-3/4" and 1/2"  
Ref.: 1023 04



La grifería GENE BRE está diseñada y fabricada según los estándares europeos de calidad, como la UNE-EN 19703 ofreciendo la funcionalidad, durabilidad y seguridad esperadas.

GENEBRE taps are designed and manufactured according to European quality standards, such as UNE-EN 19703, offering the expected functionality, durability and safety.







# Accesorios

## Accessories

Hasta el último detalle.

**Genebre te ofrece una larga lista de accesorios y complementos funcionales y decorativos ideales para combinar con nuestros modelos de grifería y dar un toque personal a cada baño.**

*Down to the last detail.*

*Genebre offers a long list of accessories and functional and decorative complements, ideal to combine with our models of taps, and give a personal touch to each bathroom.*

# Mangos de ducha / Handshowers



Consulta las especificaciones técnicas de los productos escaneando el QR  
Check the technical specifications of the products by scanning the QR



**Mango de ducha K3 jets**  
K3 jets handshower  
Ref.: DXK3 45



**Mango de ducha K1 jets**  
K1 jet handshower  
Ref.: DXK1 45



**Mango de ducha O3 jets**  
O3 jets handshower  
Ref.: DXO3 45



**Mango de ducha T3 jets**  
T3 jets handshower  
Ref.: DXT3 45



**Mango de ducha L3 jets**  
L3 jets handshower  
● Ref.: DXL3 45 - **Chrome**  
● Ref.: DXL3 41 - **Black**  
● Ref.: DXL3 51 - **Brushed Gold**  
● Ref.: DXL3 52 - **Brushed Metal**



**Mango de ducha T5 jets**  
T5 jets handshower  
Ref.: DXT5 45



**Mango de ducha E1 jet**  
E1 jet handshower  
Ref.: 100175 45 00



**Mango de ducha E2 jets**  
E2 jets handshower  
Ref.: DXE2 45



**Mango de ducha E5 jets**  
E5 jets handshower  
Ref.: DXE5 45



**Mango de ducha C1 jet**  
C1 jet handshower  
● Ref.: 100197 45 00 - **Chrome**



La grifería GENE BRE está diseñada y fabricada según los estándares europeos de calidad, como la UNE-EN 19703 ofreciendo la funcionalidad, durabilidad y seguridad esperadas.

GENEBRE taps are designed and manufactured according to European quality standards, such as UNE-EN 19703, offering the expected functionality, durability and safety.



## Kits de ducha / Shower kits



**Kit de ducha Kenjo, flexo, soporte y ducha 3 jets**  
Kenjo shower set, flexible hose, holder and 3 jets handshower  
Ref.: 100698 45



**Kit de ducha Tau, flexo, soporte y ducha 5 jets**  
Tau shower set, flexible hose, holder and 5 jets handshower  
Ref.: 100699 45



**Kit de ducha GE2, flexo, soporte y ducha 1 jet**  
GE2 shower set, flexible hose, holder and 1 jet handshower  
Ref.: 100697 45

## Flexos / Flexible hoses



**Flexo H 1/2" - H 1/2" 1,20 m inoxidable**  
F 1/2" - F 1/2" Stainless steel flexible hose 1.20 m

- Ref.: 100141 45 - **Chrome**
- Ref.: 9908 0285 - **Black**
- Ref.: 100141 51 - **Brushed Gold**
- Ref.: 100141 52 - **Brushed Metal**



**Flexo H 1/2" - H 1/2" 1,70 m inoxidable**  
F 1/2" - F 1/2" Stainless steel flexible hose 1.70 m

- Ref.: 100135 60 00 - **Chrome**
- Ref.: 9908 0287 - **Black**
- Ref.: 100135 51 00 - **Brushed Gold**
- Ref.: 100135 52 00 - **Brushed Metal**



**Flexo extensible H 1/2" - H 1/2" 1,70 - 2.25 m inoxidable**  
F 1/2" - F 1/2" Extensible stainless steel flexible hose 1.70 to 2.25 m

Ref.: 100137 60 00



**Flexo H 1/2" - H 1/2" 1,70 m PVC antirrotura**  
F 1/2" - F 1/2" PVC flexible hose 1.70 m anti-breaking

Ref.: 100140 30

## Soportes de ducha / Shower holders



**Soporte ducha Kenjo**  
Kenjo shower holder  
Ref.: 100149 45



**Soporte ducha**  
Shower holder  
Ref.: 100152 45 00



**Soporte ducha cilíndrico**  
Cylindrical shower holder  
● Ref.: 100153 45 - **Chrome**  
● Ref.: 100153 41 - **Black**  
● Ref.: 100153 51 - **Brushed Gold**  
● Ref.: 100153 52 - **Brushed Metal**



**Soporte de ducha ovalado**  
Oval shower holder  
Ref.: 100068 45



**Soporte de ducha orientable cuadrado con toma 1/2"**  
Orientable square shower holder with 1/2" connector  
Ref.: 1649 04



**Soporte de ducha cuadrado con toma 1/2"**  
Square shower holder with 1/2" connector  
Ref.: 1635 04



**Soporte ducha cilíndrico con toma 1/2"**  
Cylindrical shower holder with 1/2" connector  
● Ref.: 1634 04 - **Chrome**  
● Ref.: 1946 41 - **Black**  
● Ref.: 1946 51 - **Brushed Gold**  
● Ref.: 1946 52 - **Brushed Metal**



**Soporte de ducha orientable cilíndrico con toma 1/2"**  
Orientable cylindrical shower holder with 1/2" connector  
Ref.: 1633 04

## Tomas de ducha / Wall connectors



**Toma ducha mural cuadrada**  
Square wall connector  
Ref.: 1679 04



**Toma ducha mural redonda**  
Round wall connector  
● Ref.: 1680 04 - **Chrome**  
● Ref.: 1618 41 - **Black**  
● Ref.: 1618 51 - **Brushed Gold**  
● Ref.: 1618 52 - **Brushed Metal**

## Conjuntos barra / Bar sets



**Conjunto Kenjo, barra, flexo y ducha 3 jets**  
Kenjo set, bar, flexible hose and 3 jets  
handshower  
Ref.: 1747 45



**Conjunto Tau, barra, flexo y ducha 5 jets**  
Tau set, bar, hose and 5 jets handshower  
Ref.: 1748 45



**Barra ducha Kenjo**  
Kenjo shower bar  
Ref.: 1637 45



**Barra ducha redonda**  
Round shower bar  
Ref.: 1638 45



**Barra ducha metálica**  
Metallic shower bar  
Ref.: 1639 45



**Barra ducha TAU**  
TAU shower bar  
● Ref.: 1636 45 - **Chrome**  
● Ref.: 1636 41 - **Black**  
● Ref.: 1636 51 - **Brushed Gold**  
● Ref.: 1636 52 - **Brushed Metal**

NEW



# Rociadores y brazos / Shower heads and sprayer arms



**Rociador doble función cascada-lluvia**  
Shower head double function waterfall-rain  
Ref.: 1643 45



NEW

**Brazo pared redondo 35 cm**  
Round wall arm 35 cm  
● Ref.: B65113 18 - **Chrome**  
● Ref.: B64113 43 - **Bronze**  
● Ref.: B64113 41 - **Black**  
● Ref.: B64113 51 - **Brushed Gold**  
● Ref.: B64113 52 - **Brushed Metal**



NEW

**Brazo a techo redondo 15 cm**  
Round roof arm 15 cm  
● Ref.: 1671 45 - **Chrome**  
● Ref.: 1671 41 - **Black**  
● Ref.: 1671 51 - **Brushed Gold**  
● Ref.: 1671 52 - **Brushed Metal**



**Brazo pared cuadrado 35 cm**  
Square wall arm 35 cm  
Ref.: B63113 26



**Brazo a techo cuadrado 15 cm**  
Square roof arm 15 cm  
Ref.: 1672 45



**Brazo pared redondo 24 cm**  
Round wall 24 cm  
Ref.: B65114 18



**Rociador redondo 22 cm**  
Round shower head Ø 22 cm  
● Ref.: R65112 18 - **Chrome**



**Rociador D22 Oslo Black**  
Oslo Black D22 shower head  
● Ref.: R65112 41- **Black**



**Rociador redondo 20 cm Bronce**  
Bronze round shower head Ø 20 cm  
● Ref.: R68113 43 - **Bronze**

## Rociadores y brazos / Shower heads and sprayer arms



**Rociador cuadrado 22 cm**  
Square shower head 22 cm  
Ref.: R63112 26



**Rociador D22 ovalado**  
Oval D22 shower sprayer  
Ref.: R63112 08



**Rociador cilíndrico 10 cm**  
Cylindrical shower head 10 cm  
Ref.: R1155 04



**Rociador redondo 25 cm**  
Round shower head 25 cm

- Ref.: R65110 60 - **Chrome**
- Ref.: R65110 41 - **Black**
- Ref.: R65110 51 - **Brushed Gold**
- Ref.: R65110 52 - **Brushed Metal**

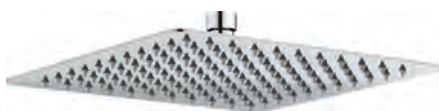

**Rociador cuadrado 25 cm Inox**  
Square shower head 25 cm

- Ref.: R65130 60 - **Chrome**
- Ref.: R65130 41 - **Black**
- Ref.: R65130 51 - **Brushed Gold**
- Ref.: R65130 52 - **Brushed Metal**



**Rociador redondo 30 cm**  
Round shower head 30 cm

- Ref.: R65150 60 - **Inox**



**Rociador cuadrado 30 cm**  
Square shower head 30 cm  
● Ref.: R65170 70 - **Inox**



**Rociador ducha con brazo**  
Wall shower arm and spray  
Ref.: 1698 45 00

# Válvulas de escuadra / Angle valves



**Válvula de escuadra cuadrada 3/8"**  
Square angle valve 3/8"

Ref.: 3106 04

**Válvula de escuadra cuadrada 1/2"**  
Square angle valve 1/2"

Ref.: 3106 05



**Válvula de escuadra redonda 3/8"**  
Round angle valve 3/8"

- Ref.: 3104 04 - **Chrome**
- Ref.: 3110 03 41 - **Black**
- Ref.: 3110 03 51 - **Brushed Gold**
- Ref.: 3110 03 52 - **Brushed Metal**

**Válvula de escuadra redonda 1/2"**  
Round angle valve 1/2"

- Ref.: 3104 05 - **Chrome**
- Ref.: 3110 04 41 - **Black**
- Ref.: 3110 04 51 - **Brushed Gold**
- Ref.: 3110 04 52 - **Brushed Metal**



**Válvula de escuadra doble 1/2" - 3/8"**  
Double angle valve 1/2" - 3/8"

Ref.: 3109 04

**Válvula de escuadra doble 1/2" - 1/2"**  
Double angle valve 1/2" - 1/2"

- Ref.: 3109 05 - **Chrome**
- Ref.: 3113 05 41 - **Black**
- Ref.: 3113 05 51 - **Brushed Gold**
- Ref.: 3113 05 52 - **Brushed Metal**



NEW

**Kit ducha sanitaria**  
Sanitary shower kit

- Ref.: 100694 45 - **Chrome**
- Ref.: 100694 41 - **Black**
- Ref.: 100694 60 - **Inox**
- Ref.: 100694 51 - **Brushed Gold**
- Ref.: 100694 52 - **Brushed Metal**



**Kit ducha sanitaria**  
Sanitary shower kit

Ref.: 100696 45



NEW

**Llave de paso 1/2"**  
1/2" Stopcock

- Ref.: 60170 41 45 66 - **Chrome**
- Ref.: 60170 41 41 66 - **Black**
- Ref.: 60170 41 51 66 - **Brushed Gold**
- Ref.: 60170 41 52 66 - **Brushed Metal**



## Kits de ducha / Shower kits



NEW

**Llave de paso 3/4"**  
3/4" Stopcock

- Ref.: 60171 41 45 66 - **Chrome**
- Ref.: 60171 41 41 66 - **Black**
- Ref.: 60171 41 51 66 - **Brushed Gold**
- Ref.: 60171 41 52 66 - **Brushed Metal**



**Mezclador sanitario de ducha con soporte**  
Sanitary shower mixer with support

- Ref.: 65144 19 45 67 - **Chrome**
- Ref.: 65144 19 41 67 - **Black**
- Ref.: 65144 19 51 67 - **Brushed Gold**
- Ref.: 65144 19 52 67 - **Brushed Metal**



**Set mezclador sanitario de ducha con soporte**  
Sanitary shower mixer set with support

- Ref.: 65144 19 45 66 - **Chrome**

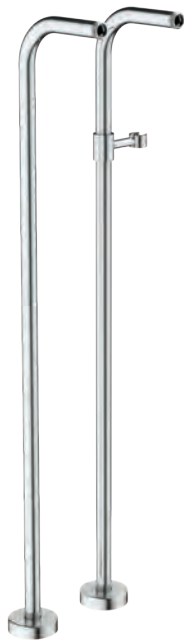

**Pies para mezclador de bañera**  
Floor support for bath mixer  
Ref.: 65120 45



La grifería GENE BRE está diseñada y fabricada según los estándares europeos de calidad, como la UNE-EN 19703 ofreciendo la funcionalidad, durabilidad y seguridad esperadas.

GENEBRE taps are designed and manufactured according to European quality standards, such as UNE-EN 19703, offering the expected functionality, durability and safety.

# Caños lavabo / Wash basin spout



## Caño mural baño cuadrado

Square wall bath spout

- Ref.: 1674 45 - **Chrome**
- Ref.: 1674 41 - **Black**
- Ref.: 1674 51 - **Brushed Gold**
- Ref.: 1674 52 - **Brushed Metal**



NEW

## Caño mural baño cilíndrico

Round wall bath spout

- Ref.: 1668 45 - **Chrome**
- Ref.: 1668 41 - **Black**
- Ref.: 1668 51 - **Brushed Gold**
- Ref.: 1668 52 - **Brushed Metal**



## Caño mural baño fundido

Casted wall bath spout

Ref.: 1667 45



## Caño mural tubo recto 16 cm

Wall-mounted pipe spout 16 cm

Ref.: 68911 45



## Caño mural tubo recto 22 cm

Wall-mounted pipe spout 22 cm

Ref.: 68912 45



## Caño mural tubo inclinado 20 cm

Wall-mounted sloping pipe spout 20 cm

Ref.: 68913 45

## Caños lavabo / Wash basin spout



---

**Caño mural tubo retro 20 cm**  
Wall-mounted retro pipe spout 20 cm  
Ref.: 68914 45



---

**Caño encimera recto tubo**  
Straight pipe spout  
Ref.: 68915 45



---

**Caño encimera cisne tubo**  
Swan neck pipe spout  
Ref.: 100696 45



---

**Caño encimera inclinado tubo**  
Sloping pipe spout  
Ref.: 68917 45



# Válvulas de desagüe/ Drain valves



NEW

**Válvula universal click Luxe con y sin rebosadero**

Luxe universal click pop-up waste with and without overflow

- Ref.: 100211 45 - **Chrome**
- Ref.: 100211 43 - **Bronze**
- Ref.: 100211 41 - **Black**
- Ref.: 100211 51 - **Brushed Gold**
- Ref.: 100211 52 - **Brushed Metal**



**Tapa universal "Click remove"**

"Click remove" universal cover

Ref.: 100202 45



NEW

**Válvula universal click con y sin rebosadero**

Universal click pop-up waste with and without overflow

Ref.: 100205 45



**Válvula universal click Kenjo con y sin rebosadero**

Kenjo universal click pop-up waste with and without overflow

Ref.: 100204 45



**Válvula universal click lavabo y bidé click con rebosadero**

Click pop-up waste for basin and bidet with overflow

Ref.: 100206 45



**Válvula universal lavabo y bidé click**

Click pop-up waste for basin and bidet

Ref.: 100207 45



NEW

**Válvula universal click para bañera**

Click pop-up waste for bath

- Ref.: 100208 45 - **Chrome**
- Ref.: Ref.: 100208 43 - **Bronze**



NEW

**Válvula universal click lavabo y bidé click doble función**

Double function click pop-up waste for basin and bidet

Ref.: 100209 45



NEW

**Válvula universal click lavabo y bidé click doble función**

Double function click pop-up waste for basin and bidet

Ref.: 100210 45



**Válvula automática plástico 1 1/4"**

1 1/4" plastic automatic valve

Ref.: 100200 45



**Válvula automática metálica 1 1/4"**

1 1/4" metallic automatic valve

Ref.: 100203 45

## Sifones / Siphons



**Sifón botella cuadrado para lavabo y bidé 1 1/4"**  
Square 1 1/4" bidet and wash-basin siphon  
Ref.: 1621 07

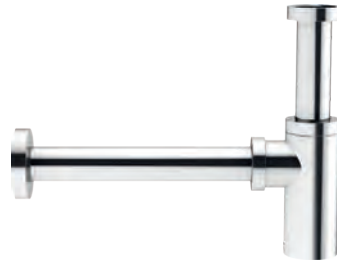

**Sifón botella redondo para lavabo y bidé 1 1/4"**  
Round 1 1/4" bidet and wash-basin siphon  
● Ref.: 1622 07 - **Chrome**  
● Ref.: 1626 41 - **Black**  
● Ref.: 1626 51 - **Brushed Gold**  
● Ref.: 1626 52 - **Brushed Meta**



**Tubo alargo vertical sifón 1 1/4"**  
Vertical enlarge tube 1 1/4" siphon  
● Ref.: 1632 00 - **Chrome**  
● Ref.: 1648 41 - **Black**  
● Ref.: 1648 51 - **Brushed Gold**  
● Ref.: 1648 52 - **Brushed Meta**



NEW

**Tubo alargo horizontal sifón 1 1/4"**  
Horizontal enlarge tube 1 1/4" siphon  
● Ref.: 1640 07 - **Chrome**  
● Ref.: 1650 41 - **Black**  
● Ref.: 1650 51 - **Brushed Gold**  
● Ref.: 1650 52 - **Brushed Metal**

## Reguladores de caudal Flow regulator

Para duchas / For showers



**Conector 1/2" con regulador caudal**  
1/2" Connector with flow regulator

**Consumo litros x minuto**  
Consumption in litres x minute

Ref.: 9908 0300	<b>3L</b>
Ref.: 9908 0301	<b>4L</b>
Ref.: 9908 0302	<b>5L</b>
Ref.: 9908 0303	<b>6L</b>
Ref.: 9908 0304	<b>8L</b>
Ref.: 9908 0305	<b>10L</b>
Ref.: 9908 0306	<b>12L</b>
Ref.: 9908 0307	<b>14L</b>

## Aireadores Aerators

Aerators / For taps



NEW

**Aireador M24x1 antical economizador**  
M24x1 Anti-lime economizer aerator

**Consumo litros x minuto**  
Consumption in litres x minute

Ref.: 9908 0311	<b>2L</b>
Ref.: 9908 0312	<b>4L</b>
Ref.: 9908 0313	<b>5L</b>
Ref.: 9908 0314	<b>6L</b>
Ref.: 9908 0315	<b>8L</b>



Para instalaciones con baja presión, recomendamos los aireadores ref. 9908 0310 (M24X1) y 9908 0316 (H22X1), ofrecen alta sensación de confort con consumo de 5 litros a los 0,2 Bar.

For installations with very low pressure, we offer aerators ref. 9908 0310 (M24X1) and 9908 0316 (F22X1), that offer a great feeling of comfort with a consumption of 5 litres at 0.2 Bar.

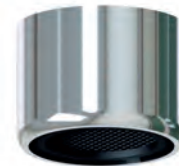

NEW

**Aireador H22x1 antical economizador**  
F22x1 Anti-lime economizer aerator

**Consumo litros x minuto**  
Consumption in litres x minute

Ref.: 9908 0317	<b>2L</b>
Ref.: 9908 0318	<b>4L</b>
Ref.: 9908 0319	<b>5L</b>
Ref.: 9908 0320	<b>6L</b>
Ref.: 9908 0321	<b>8L</b>

**Aireador antical M24x1 baja presión**  
M24x1 Anti-lime low pressure aerator  
Ref.: 9908 0310

**Aireador antical H22x1 baja presión**  
F22x1 Anti-lime low pressure aerator  
Ref.: 9908 0316

## Ahorro de agua y energía Water and energy saving

Ahora GENE BRE presenta su amplia gama de economizadores, tanto para baño como cocina.

Nuestros conectores con regulador de caudal para ducha y aireadores antical economizadores ideales para grifos, harán que tus instalaciones sean más eficientes en el consumo de agua y energía.

### Consumo más sostenible

Gracias al sistema de regulación dinámica, la reducción se produce sea cual sea la presión del agua.

En los aireadores, su mezclado de agua con aire ofrece una gran sensación de confort, a la vez que se reduce el consumo, haciéndolo más eficiente y sostenible. Además, al reducir su caudal, también se ahorra energía en la fase de calentamiento del agua.



**Ahorro de agua, hasta 20 litros minuto.**  
Water saving, up to 20 litres minute

Now GENE BRE presents its wide range of economizers, for both bathroom and kitchen.

Our connectors with flow regulator for showers, and antical economizing aerators ideal for taps, will make your installations more efficient in terms of water and energy consumption.

### More sustainable consumption

Thanks to the dynamic regulation system, the reduction occurs whatever the water pressure.

In aerators, mixing water with air offers a great feeling of comfort, while reducing consumption, making it more efficient and sustainable. In addition, by reducing the flow, you also save energy in the water heating phase.

**Los economizadores GENE BRE ayudan a conseguir las certificaciones más exigentes.**  
The GENE BRE economizers help achieve the most demanding certifications.



## Filtros / Filters



**Kit dechlorador**  
Dechlorinator kit  
Ref.: FT00



**Kit ultrafiltración**  
Ultrafiltration kit  
Ref.: FT01



**Filtro ultrafiltración**  
Ultrafiltration filter  
Ref.: FT91



**Filtro dechloración**  
Dechlorinator filter  
Ref.: FT92

## Accesorios / Accessories



**Conjunto florón y excéntricas gigantes**  
Giant scutcheon and eccentric set  
Ref.: 100122 45



**Placa adaptadora 4"**  
4" adaptor plate  
Ref.: P130



**Placa adaptadora 8"**  
8" adaptor plate  
Ref.: P200

# Accesorios para la instalación

Installation accessories

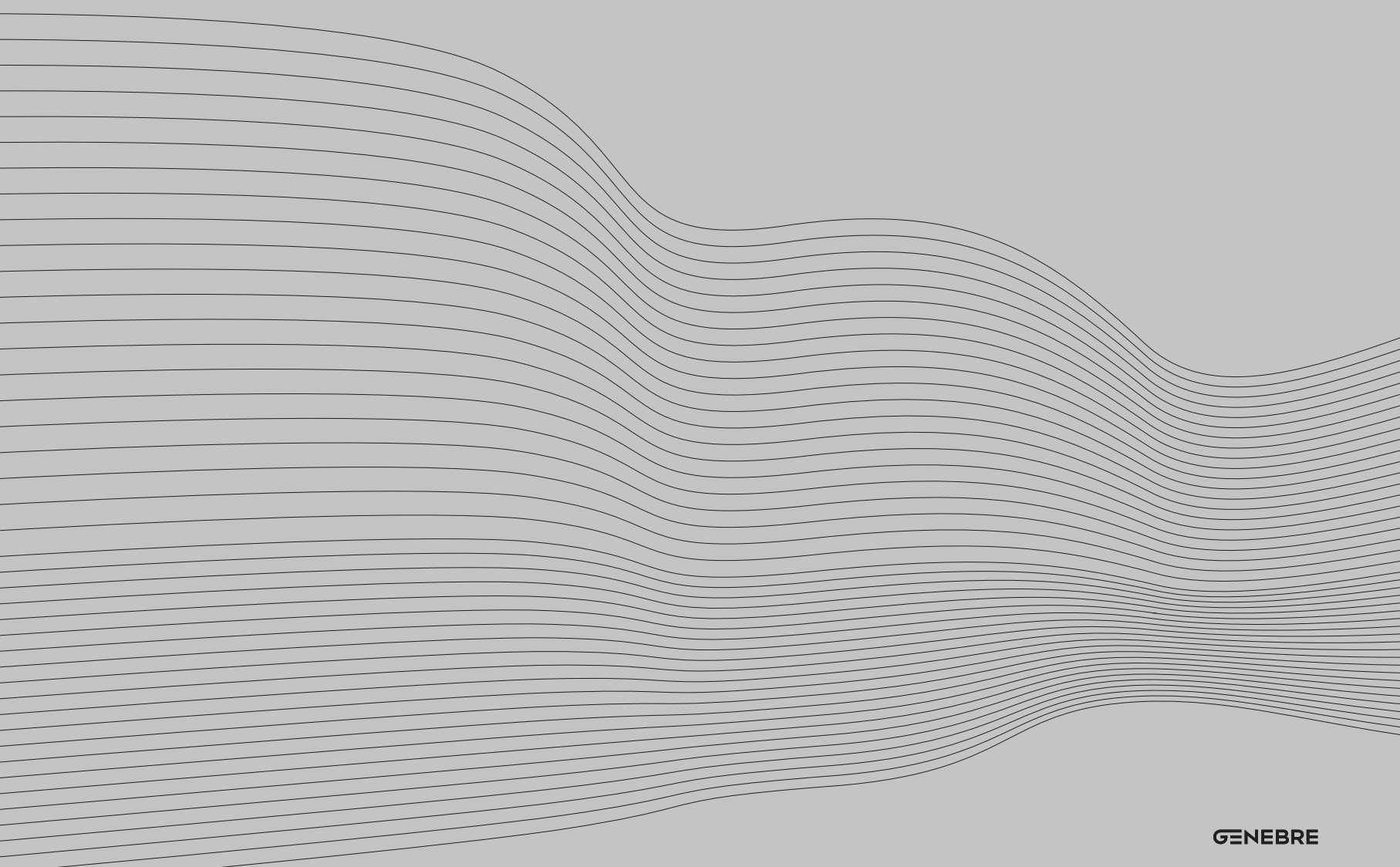

# Accesorios para la instalación / Installation accessories



NEW

**Caja instalacion GEBOX 115**  
Installation box 115 GEBOX  
Ref.: 115BOX



NEW

**Caja instalacion GEBOX 116**  
Installation box 116 GEBOX  
Ref.: 116BOX



NEW

**Caja instalacion GEBOX 118**  
Installation box 118 GEBOX  
Ref.: 118BOX



NEW

**Inversor largo**  
Long diverter  
Ref.: EXT0001



NEW

**Inversor largo negro**  
Black long diverter  
Ref.: EXT0002



NEW

**Kit extensor cartucho 40mm**  
Extension kit 40mm cartridge  
Ref.: EXT0003



NEW

**Kit extensión inversor cerámico**  
Extension kit ceramic diverter  
Ref.: EXT0004



NEW

**Kit extensión cartucho 35mm**  
Extension kit 35mm cartridge  
Ref.: EXT0005



NEW

**Kit extensión cartucho negro 35mm**  
Blanck extension kit 35mm cartridge  
Ref.: EXT0006



# Empotrados con caja de instalación

Built-in with installation box

# Empotrados con caja de instalación / Built-in with installation box



NEW

**Monomando empotrado 1 vía GEBOX**  
GEBOX Built-in single lever shower mixer  
Ref.: B115 40 10



NEW

**Monomando empotrado 2 vías GEBOX**  
GEBOX Built-in single lever mixer 2-way  
Ref.: B117 40 10



NEW

**Monomando empotrado 3 vías GEBOX**  
GEBOX Built-in single lever mixer 3-way  
Ref.: B118 40 10



NEW

**Kit Placa redonda para empotrada**  
Built-in round plate Kit  
● Ref.: KPB115 40 - Chrome



NEW

**Kit Placa ducha empotrada**  
Built-in shower mixer plate Kit  
● Ref.: KPC115 40 45 - Chrome



NEW

**Kit Placa ducha empotrada**  
Built-in shower mixer plate Kit  
● Ref.: KPT115 40 45 - Chrome



NEW

**Kit Placa redonda empotrada 2 vías**  
Built-in 2 way round plate Kit  
● Ref.: KPB117 40 45 - Chrome



NEW

**Kit Placa empotrada 2 vías**  
Built-in 2 way plate Kit  
● Ref.: KPC117 40 45 - Chrome



NEW

**Kit Placa rectangular empotrada 2 vías**  
Built-in 2 way rectangular plate Ki  
● Ref.: KPT117 40 45 - Chrome



NEW

**Kit Placa redonda empotrada 3 vías**  
Built-in 3 way round plate Kit  
● Ref.: KPB118 40 45 - Chrome



NEW

**Kit Placa empotrada 3 vías**  
Built-in 3 way plate Ki  
● Ref.: KPC118 40 45 - Chrome



NEW

**Kit Placa rectangular empotrada 3 vías**  
Built-in 3 way rectangular plate Kit  
● Ref.: KPT118 40 45 - Chrome



**¡Enlaza al video y conoce mejor nuestro sistema GEBOX!**

Link to the video and learn about our GEBOX system!



NEW

**Kit Placa ducha empotrada Negro**  
Black Built-in shower mixer plate Kit  
● Ref.: KPC115 40 41 - **Black**



NEW

**Kit Placa empotrada 2 vías Negro**  
Black Built-in 2 way plate Kit  
● Ref.: KPC117 40 41 - **Black**



NEW

**Kit Placa empotrada 3 vías Negro**  
Black Built-in 3 way plate Kit  
● Ref.: KPC118 40 41 - **Black**



NEW

**Maneta K8**  
K8 lever  
● Ref.: 100001 28 45 - **Chrome**



NEW

**Maneta Ge2**  
Ge2 lever  
● Ref.: 100001 22 45 - **Chrome**



NEW

**Maneta Tau**  
Tau lever  
● Ref.: 100001 18 45 - **Chrome**



NEW

**Maneta Tau 2**  
Tau 2 lever  
● Ref.: 100001 29 45 - **Chrome**



NEW

**Maneta Korál**  
Koral lever  
● Ref.: 100001 32 45 - **Chrome**



NEW

**Maneta Kode corta**  
Short Kode lever  
● Ref.: 100001 31 45 - **Chrome**



# Packaging

## Packaging con diseño e identidad visual fácilmente identificable

Packaging with easily identifiable design and visual identity



El packaging de los productos Genebre incluye toda la información necesaria para identificar el producto, además también disponen de QR para ampliar información si se desea.

*The packaging of Genebre products includes all the information necessary to identify the product, and in many cases a QR can also be found to provide more information.*

# Punto de venta

## Point of sale

### Expositores para mayor visibilidad en el punto de venta

Displays for greater visibility at the point of sale



Los expositores Genebre están formulados para mayor visibilidad en el espacio de venta. De este modo se consigue impulsar y reforzar la identidad corporativa de nuestros productos y mejorar la experiencia de compra.

*Genebre displays are formulated for greater visibility in the sales space. In this way, it is possible to promote and reinforce the corporate identity of our products and improve the purchasing experience.*

**Consultar condiciones para soporte en el punto de venta en**

**[comunicacion@genebre.es](mailto:comunicacion@genebre.es)**

*Consult conditions for support at the point of sale at*





# Recambios

Spare parts

La importancia de las piezas.

Es importante disponer de las piezas de recambio para mantener el baño siempre en perfecto estado aunque pase el tiempo. Por eso, contamos con una gran colección de piezas exclusivas con la misma calidad de siempre.

*The importance of the parts.*

*It is important to have the spare parts available to always keep the bathroom in a perfect state through the pass of time. Therefore, we have a large collection of exclusive pieces with the same quality as always.*



**Maneta**  
Handle

Ref.:	Descripción   Description
100001 05 45	<b>Maneta Sara</b>   Sara lever
100001 08 45	<b>Maneta Kode</b>   Kode lever
100001 16 45	<b>Maneta Klip</b>   Klip lever
100001 18 45	<b>Maneta Tau</b>   Tau lever
100001 19 45	<b>Maneta Oslo</b>   Oslo lever
100001 22 45	<b>Maneta GE2</b>   GE2 lever
100001 26 45	<b>Maneta Kenjo</b>   Kenjo lever
100001 28 45	<b>Maneta K8</b>   K8 lever
100001 29 45	<b>Maneta Tau 2</b>   Tau 2 lever
100001 31 45	<b>Maneta Kode corta</b>   Short Kode lever
100001 32 41	<b>Maneta Koral Negra</b>   Black Koral lever
100001 32 45	<b>Maneta Koral</b>   Koral lever
100001 33 45	<b>Maneta GE2 corta</b>   Short GE2 lever
100001 34 41	<b>Maneta Kloe Ø25</b>   Kloe lever Ø25
100001 34 45	<b>Maneta Kloe Ø25</b>   Kloe lever Ø25
100001 34 51	<b>Maneta Kloe Ø25</b>   Kloe lever Ø25
100001 34 52	<b>Maneta Kloe Ø25</b>   Kloe lever Ø25
100001F 16 45	<b>Maneta Kelogic</b>   Kelogic lever
100001F 19 45	<b>Maneta Oslo apertura en frio</b>   Cold start Oslo lever
100001F 28 45	<b>Maneta K8 apertura en frio</b>   Cold start K8 lever
100001F 32 45	<b>Maneta Koral apertura en frio</b>   Cold start Koral lever
100001R 16 45	<b>Maneta Kelogic marcado vertical</b>   Vertical marked Kelogic lever
100001R 19 45	<b>Maneta Oslo marcado frio vertical</b>   Vertical marked cold Oslo lever
100001T 32 45	<b>Maneta columna Koral</b>   Koral column lever
100001T 32 41	<b>Maneta 2p Koral Negra</b>   Black 2p Koral lever
100001V 05 45	<b>Maneta Sara marcado vertical</b>   Vertical marked Sara lever
100001V 16 45	<b>Maneta Klip marcado vertical</b>   Vertical marked Klip lever
100001V 18 41	<b>Maneta Tau marcado vertical Negra</b>   Black marked Tau lever
100001V 18 44	<b>Maneta Tau marcado vertical a.Inox</b>   SS F. marked Tau lever
100001V 18 45	<b>Maneta Tau marcado vertical</b>   Vertical marked Tau lever
100001V 18 60	<b>Maneta Tau Inox marcado vertical</b>   Vertical marked Tau Inox lever
100001V 19 45	<b>Maneta Oslo marcado vertical</b>   Vertical marked Oslo lever
100001V 28 45	<b>Maneta K8 marcado vertical</b>   Vertical marked K8 lever
100001V 32 45	<b>Maneta Koral marcado vertical</b>   Vertical marked Koral lever
100001V 33 45	<b>Maneta GE2 corta marcado vertical</b>   Vertical marked short GE2 lever
100001V 37 45	<b>Maneta Tau 35 marcado vertical</b>   Vertical marked Tau 35 lever
100001V 39 43	<b>Maneta New Regent marcado vertical bronce</b>   Vertical marked New Regent bronze lever
100001V 39 45	<b>Maneta New Regent marcado vertical</b>   Vertical marked New Regent lever
100001V 40 60	<b>Maneta Flat</b>   Flat handle
100002 34 41	<b>Maneta Kloe Ø35</b>   Kloe lever Ø35
100002 34 45	<b>Maneta Kloe Ø35</b>   Kloe lever Ø35



**Maneta**  
Handle

Ref.:	Descripción   Description
100002 34 51	<b>Maneta Kloe Ø35</b>   Kloe lever Ø35
100002 34 52	<b>Maneta Kloe Ø35</b>   Kloe lever Ø35
9908 0039	<b>Maneta FRT65401</b>   FRT65401 lever
9908 0040	<b>Maneta FRT65402</b>   FRT65402 lever
9908 0041	<b>Maneta FRV61205</b>   FRV61205 lever
9908 0045	<b>Maneta FRK</b>   FRK lever
9908 0218	<b>Maneta columna Tau D35</b>   D 35 Tau column handle
9908 0219	<b>Maneta columna Tau 2 D35</b>   D35 Tau 2 column handle
9908 0222	<b>Maneta para FRV61207 Blanca</b>   White Lever for FRV61207
9908 0225	<b>Maneta para FRV61207 Negra</b>   Black Lever for FRV61207
9908 0235	<b>Maneta inversor columna Oslo</b>   Oslo column diverter lever
9908 0241	<b>Maneta FRT65401 Blanca</b>   White FRT65401 lever
9908 0243	<b>Maneta 65403 18 41 66</b>   65403 18 41 66 lever
9908 0251	<b>Maneta para 65212 18 45 66</b>   Lever for 65212 18 45 66
9908 0278	<b>Maneta Oslo Negra</b>   Black Oslo lever
9908 0370	<b>Maneta inversor columna Oslo Negro</b>   Black Oslo column diverter lever
9908 0389	<b>Maneta FRT65401 a. INOX</b>   F. SS FRT65401 lever
9908 0392	<b>Maneta para FRV61207 a. INOX</b>   F. SS Lever for FRV61207
9908 0395	<b>Maneta FRV61208</b>   Lever for FRV61208
9908 0398	<b>Maneta FRV61208 Negra</b>   Black Lever for FRV61208
9908 0438	<b>Maneta FRV61208 a. INOX</b>   F. SS Lever for FRV61208
9908 0455	<b>Maneta mezclador sanitario</b>   Lever sanitary mixer
9908 0459	<b>Maneta mezclador sanitario Negra</b>   Black sanitary mixer lever
9908 0469	<b>Maneta mezclador sanitario</b>   Lever sanitary mixer
9908 0470	<b>Maneta mezclador sanitario</b>   Lever sanitary mixer





**Florón**  
Scutcheon

Ref.:	Descripción   Description
9908 0297	<b>Cobertor Inversor Negro</b>   Black Diverter Cover
9908 0447	<b>Cobertor Inversor</b>   Diverter Cover
68988 18	<b>Kit volantes columnas termostáticas Tau</b>   Tau thermostatic column handle set
68989 26	<b>Kit volantes columnas termostáticas Kenjo</b>   Kenjo thermostatic column handle set
68991 14	<b>Kit volantes termostática Tau</b>   Tau thermostatic mixer handle set
68992 26	<b>Kit volantes termostáticas Kenjo</b>   Kenjo thermostatic mixer handle set
68994 14	<b>Kit volantes termostática</b>   Thermostatic mixer handle set
68998 07 45	<b>Volante Kalo</b>   Kalo handle
68998 08 45	<b>Volante Kross</b>   Kross handle
68998 09 43	<b>Volante Regent bronce</b>   Bronze Regent handle
68998 09 45	<b>Volante Regent</b>   Regent handle
68998 11 45	<b>Volante Gamma</b>   Gamma handle
68998 12 45	<b>Volante Ixo</b>   Ixo handle
68998 28 45	<b>Volante Office</b>   Office handle
68998 30 45	<b>Volante Tau</b>   Tau handle
68998 31 45	<b>Volante osmosis</b>   Osmosis handle
9908 0056	<b>Kit volante termostatica empotrada 2 y 3 vías</b>   Built-in 2 and 3 ways thermostatic handle set
9908 0100	<b>Cobertor cartucho termostático</b>   Thermostatic cartridge cover
9908 0101	<b>Volante cartucho termostático</b>   Thermostatic cartridge handle
9908 0103	<b>Soporte florón para 568120 45</b>   Scutcheon support for 568120 45
9908 0205	<b>Volante inversor set redondo</b>   Round set diverter handle
9908 0215	<b>Volante inversor set cuadrado</b>   Square set diverter handle
9908 0217	<b>Volante inversor columna redonda</b>   Round column diverter handle
9908 0220	<b>Kit volantes columnas monomando cuadradas</b>   Square single handle column handle set
9908 0234	<b>Volante inversor set Oslo</b>   Oslo set diverter handle
9908 0376	<b>Volante inversor set Oslo Negro</b>   Black Oslo set diverter handle
9908 0239	<b>Volante montura columna Oslo</b>   Oslo column headwork handle
9908 0373	<b>Volante inversor columna Oslo Negro</b>   Black Oslo column diverter handle
9908 0240	<b>Volante cartucho columna Oslo</b>   Oslo column cartridge handle
9908 0272	<b>Volante grifo de 1 vía</b>   Handle for one way tap
9908 0451	<b>Volante llave de paso</b>   Stopcock handle
9908 0443	<b>Volante llave de paso Negro</b>   Black Stopcock handle
68998 31 41	<b>Volante osmosis Negro</b>   Black Osmosis handle
68998 31 44	<b>Volante osmosis a.Inox</b>   SS F. Osmosis handle
68998 30 41	<b>Volante inversor cerámico Negro</b>   Black ceramic diverter handle
DH0001 45	<b>Volante inversor</b>   Diverter handle
DH0001 41	<b>Volante inversor Negro</b>   Black Diverter handle
9908 0481	<b>Volante llave de paso</b>   Stopcock handle
9908 0482	<b>Volante llave de paso</b>   Stopcock handle
9908 0103	<b>Soporte florón para 568120 45</b>   Scutcheon support for 568120 45



Florón  
Scutcheon

Ref.:	Descripción   Description
9908 0297	<b>Cobertor Inversor Negro</b>   Black Diverter Cover
9908 0447	<b>Cobertor Inversor</b>   Diverter Cover
68988 18	<b>Kit volantes columnas termostáticas Tau</b>   Tau thermostatic column handle set
68989 26	<b>Kit volantes columnas termostáticas Kenjo</b>   Kenjo thermostatic column handle set
68991 14	<b>Kit volantes termostática Tau</b>   Tau thermostatic mixer handle set
68992 26	<b>Kit volantes termostáticas Kenjo</b>   Kenjo thermostatic mixer handle set
68994 14	<b>Kit volantes termostática</b>   Thermostatic mixer handle set
68998 07 45	<b>Volante Kalo</b>   Kalo handle
68998 08 45	<b>Volante Kross</b>   Kross handle
68998 09 43	<b>Volante Regent bronce</b>   Bronze Regent handle
68998 09 45	<b>Volante Regent</b>   Regent handle
68998 11 45	<b>Volante Gamma</b>   Gamma handle
68998 12 45	<b>Volante Ixo</b>   Ixo handle
68998 28 45	<b>Volante Office</b>   Office handle
68998 30 45	<b>Volante Tau</b>   Tau handle
68998 31 45	<b>Volante osmosis</b>   Osmosis handle
9908 0056	<b>Kit volante termostática empotrada 2 y 3 vías</b>   Built-in 2 and 3 ways thermostatic handle set
9908 0100	<b>Cobertor cartucho termostático</b>   Thermostatic cartridge cover
9908 0101	<b>Volante cartucho termostático</b>   Thermostatic cartridge handle
9908 0103	<b>Soporte florón para 568120 45</b>   Scutcheon support for 568120 45
9908 0205	<b>Volante inversor set redondo</b>   Round set diverter handle
9908 0215	<b>Volante inversor set cuadrado</b>   Square set diverter handle
9908 0217	<b>Volante inversor columna redonda</b>   Round column diverter handle
9908 0220	<b>Kit volantes columnas monomando cuadradas</b>   Square single handle column handle set
9908 0234	<b>Volante inversor set Oslo</b>   Oslo set diverter handle
9908 0376	<b>Volante inversor set Oslo Negro</b>   Black Oslo set diverter handle
9908 0239	<b>Volante montura columna Oslo</b>   Oslo column headwork handle
9908 0373	<b>Volante inversor columna Oslo Negro</b>   Black Oslo column diverter handle
9908 0240	<b>Volante cartucho columna Oslo</b>   Oslo column cartridge handle
9908 0272	<b>Volante grifo de 1 vía</b>   Handle for one way tap
9908 0451	<b>Volante llave de paso</b>   Stopcock handle
9908 0443	<b>Volante llave de paso Negro</b>   Black Stopcock handle
68998 31 41	<b>Volante osmosis Negro</b>   Black Osmosis handle
68998 31 44	<b>Volante osmosis a.Inox</b>   SS F. Osmosis handle
68998 30 41	<b>Volante inversor cerámico Negro</b>   Black ceramic diverter handle
DH0001 45	<b>Volante inversor</b>   Diverter handle
DH0001 41	<b>Volante inversor Negro</b>   Black Diverter handle
9908 0481	<b>Volante llave de paso</b>   Stopcock handle
9908 0482	<b>Volante llave de paso</b>   Stopcock handle
9908 0103	<b>Soporte florón para 568120 45</b>   Scutcheon support for 568120 45



**Florón**  
Scutcheon

Ref.:	Descripción   Description
9908 0102	<b>Florón para 568120 45</b>   Scutcheon for 568120 45
9908 0379	<b>65200 19 45 66 Base</b>   Base to 65200 19 45 66
9908 0386	<b>Florón deslizante</b>   Sliding cover
9908 0446	<b>Cobertor Cartucho D40</b>   D40 Cartridge Cover
9908 0387	<b>Cobertor fijo</b>   Fix cover
9908 0447	<b>Cobertor Inversor</b>   Diverter Cover
9908 0445	<b>Cobertor D40</b>   D40 Cover
9908 0293	<b>Cobertor D40 Negro</b>   Black D40 Cover
9908 0295	<b>Cobertor Cartucho D40 Negro</b>   Black D40 Cartridge Cover
9908 0297	<b>Cobertor Inversor Negro</b>   Black Diverter Cover



**Duchas**  
Shower

100131 60	<b>Mango ducha inoxidable</b>   SS hand shower
100175 45 00	<b>Mango de ducha E1 jet</b>   E1 jet handshower
100187 45	<b>Aireador extraíble</b>   Pull-out aerator
100190 45	<b>Mango ducha de fregadera extraíble</b>   Pull-out sink tap sprayer
100196 43 00	<b>Mango de ducha New Regent bronce</b>   New Regent bronze hand shower
100196 45 00	<b>Mango de ducha New Regent cromo</b>   New Regent chromed hand shower
100197 45 00	<b>Mango de ducha C1 jet</b>   C1 jet handshower
100199 45	<b>Mango ducha extraíble para FRV61205</b>   Pull-out FRV61205 sink tap sprayer
100252 45	<b>Mango extraíble fregadera</b>   Pull-out sink tap sprayer
100696 45	<b>Kit ducha sanitaria</b>   Sanitary shower kit
9908 0223	<b>Aireador extraíble Negro</b>   Black Pull-out aerator
9908 0214	<b>Aireador extraíble Blanco</b>   White Pull-out aerator
9908 0246	<b>Mango de ducha</b>   Handshower
9908 0248	<b>Mango de ducha</b>   Handshower
9908 0255	<b>Mango Ducha para 65212 18 45 66</b>   Hand shower for 65212 18 45 66
9908 0260	<b>Aireador extraíble</b>   Pull-out aerator
9908 0325	<b>Mango de ducha Negro</b>   Black Handshower
9908 0390	<b>Aireador extraíble a.Inox</b>   SS F. Pull-out aerator
DXK3 45	<b>Mango de ducha K3 jets</b>   K3 jets handshower
DXL3 45	<b>Mango de ducha L3 jets</b>   L3 jets handshower
DXL3 41	<b>Mango de ducha L3 jets</b>   L3 jets handshower
DXL3 51	<b>Mango de ducha L3 jets</b>   L3 jets handshower
DXL3 52	<b>Mango de ducha L3 jets</b>   L3 jets handshower
DXT5 45	<b>Mango de ducha T5 jets</b>   T5 jets handshower
R63112 26	<b>Rociador cuadrado 22 cm</b>   Square shower head 22 cm
R65112 18	<b>Rociador redondo 22 cm</b>   Round shower head Ø 22 cm
R65112 19	<b>Rociador D22 Oslo</b>   Oslo D22 shower head
R65112 41	<b>Rociador D22 Oslo Black</b>   Oslo Black D22 shower head
9908 0396	<b>Mango ducha extraíble para FRV61208</b>   Pull-out FRV61208 sink tap sprayer
9908 0399	<b>Mango ducha extraíble para FRV61208 Negra</b>   Black Pull-out FRV61208 sink tap sprayer





**Duchas**  
Shower



**Flexo**  
Flexible hose

Ref.:	Descripción   Description
9908 0435	<b>Mango ducha extraíble para FRV61208 Blanca</b>   White Pull-out FRV61208 sink tap sprayer
9908 0439	<b>Mango ducha extraíble para FRV61208 a. INOX</b>   F. SS Pull-out FRV61208 sink tap sprayer
DB142 45	<b>Ducha bidet con transmisión</b>   Shower bidet mixer with diverter
DB142 41	<b>Ducha bidet con transmisión</b>   Shower bidet mixer with diverter
DB142 51	<b>Ducha bidet con transmisión</b>   Shower bidet mixer with diverter
DB142 52	<b>Ducha bidet con transmisión</b>   Shower bidet mixer with diverter
100135 43 00	<b>Flexo H 1/2" - H 1/2" bronce 1,7 m</b>   F 1/2" - F 1/2" bronze 1.7 m flexible hose
100135 60 00	<b>Flexo H 1/2" - H 1/2" 1,70 m inoxidable</b>   F 1/2" - F 1/2" Stainless steel flexible hose 1.70 m
100135 41 00	<b>Flexo H 1/2" - H 1/2" 1,70 m inoxidable</b>   F 1/2" - F 1/2" Stainless steel flexible hose 1.70 m
100135 51 00	<b>Flexo H 1/2" - H 1/2" 1,70 m inoxidable</b>   F 1/2" - F 1/2" Stainless steel flexible hose 1.70 m
100135 52 00	<b>Flexo H 1/2" - H 1/2" 1,70 m inoxidable</b>   F 1/2" - F 1/2" Stainless steel flexible hose 1.70 m
100140 30	<b>Flexo H 1/2" - H 1/2" 1,70 m. PVC antirrotura</b>   F 1/2" - F 1/2" PVC flexible hose 1.70 m anti-breaking
100141 45	<b>Flexo H 1/2" - H 1/2" 1,20 m inoxidable</b>   F 1/2" - F 1/2" Stainless steel flexible hose 1.20 m
100143 45	<b>Flexo flegadera 15 x 1 - H 1/2" 1,15 m</b>   15 x 1 - F 1/2" 1,15 m pull-out sink tap hose
100143 60	<b>Flexo fregadera para 65211 18 60 66</b>   Sink tap hose for 65211 18 60 66
9908 0080	<b>Flexo para 65207 18 60 66</b>   Flexible hose for 65207 18 60 66
9908 0203	<b>Flexo H 1/2" - H 1/2" 0,6 m cromado</b>   F 1/2" - F 1/2" 0.6 m chromed flexible hose
9908 0377	<b>Flexo H 1/2" - H 1/2" 0,6 m Negro</b>   F 1/2" - F 1/2" 0.6 m Black flexible hose
9908 0206	<b>Flexo H 1/2" - H 1/2" 1,5 m cromado</b>   F 1/2" - F 1/2" 1.5 m chromed flexible hose
9908 0368	<b>Flexo H 1/2" - H 1/2" 1,5 m Negro</b>   F 1/2" - F 1/2" 1.5 m Black flexible hose
9908 0213	<b>Flexo para FRV61207</b>   Flexible hose for FRV61207
9908 0393	<b>Flexo para FRV61207 a. INOX</b>   F. SS Flexible hose for FRV61207
9908 0256	<b>Flexo para 65212 18 45 66</b>   Flexible hose for 65212 18 45 66
9908 0258	<b>Flexo para 65219 18 45 66</b>   Flexible hose for 65219 18 45 66
9908 0262	<b>Flexo para FRV61206</b>   Flexible hose for FRV61206
100141 51	<b>Flexo H 1/2" - H 1/2" 1,20 m inoxidable</b>   F 1/2" - F 1/2" Stainless steel flexible hose 1.20 m
100141 52	<b>Flexo H 1/2" - H 1/2" 1,20 m inoxidable</b>   F 1/2" - F 1/2" Stainless steel flexible hose 1.20 m
100067 45	<b>Soporte ducha GE2</b>   GE2 shower holder
100149 45	<b>Soporte ducha Kenjo</b>   Kenjo shower holder
100152 45 00	<b>Soporte ducha</b>   Shower holder
100153 45	<b>Soporte ducha cilíndrico</b>   Cylindrical shower holder
100153 41	<b>Soporte ducha cilíndrico</b>   Cylindrical shower holder
100153 51	<b>Soporte ducha cilíndrico</b>   Cylindrical shower holder
100153 52	<b>Soporte ducha cilíndrico</b>   Cylindrical shower holder
1647 43	<b>Soporte ducha Clásico bronce</b>   Classic bronze shower holder
1647 45	<b>Soporte ducha Clásico</b>   Classic shower holder
9908 0172	<b>Soporte superior set redondo</b>   Upper holder of round set
9908 0173	<b>Soporte superior set cuadrado</b>   Upper holder of square set
9908 0226	<b>Soporte columna redonda</b>   Round column holder

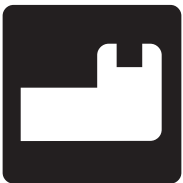

**Soporte ducha fijos**  
Fixed shower holders

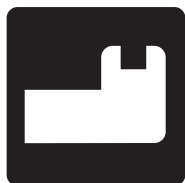

**Soporte ducha fijos**  
Fixed shower holders

Ref.:	Descripción   Description
9908 0227	<b>Soporte columna cuadrada</b>   Square column holder
9908 0232	<b>Soporte columna Oslo</b>   Oslo column holder
9908 0366	<b>Soporte columna Oslo Negro</b>   Black Oslo column holder
9908 0245	<b>Soporte deslizante columna Koral</b>   Koral column sliding shower holder
9908 0254	<b>Soporte ducha para 65212 18 45 66</b>   Shower holder for 65212 18 45 66
9908 0259	<b>Soporte ducha para 65219 18 45 66</b>   Shower holder for 65219 18 45 66
9908 0286	<b>Soporte ducha Negro</b>   black Shower holder
9908 0457	<b>Soporte mezclador sanitario</b>   Sanitary mixer shower holder
9908 0461	<b>Soporte mezclador sanitario Negro</b>   Black sanitary mixer shower holder
9908 0475	<b>Soporte mezclador sanitario</b>   Sanitary mixer shower holder
9908 0476	<b>Soporte mezclador sanitario</b>   Sanitary mixer shower holder
9908 0485	<b>Soporte Ducha</b>   Shower holder
1634 04	<b>Soporte de ducha cilíndrico con toma 1/2"</b>   Cylindrical shower holder with 1/2" connector



**Soporte ducha deslizante**  
Sliding shower holders

9908 0076	<b>Soporte deslizante ducha para 1636 45</b>   Sliding shower holder for 1636 45
9908 0077	<b>Soporte deslizante ducha para 1637 45</b>   Sliding shower holder for 1637 45
9908 0078	<b>Soporte deslizante ducha para 1638 45</b>   Sliding shower holder for 1638 45
9908 0079	<b>Soporte deslizante ducha para 1639 45</b>   Sliding shower holder for 1639 45
9908 0201	<b>Soporte deslizante columna redonda</b>   Round column shower holder
9908 0211	<b>Soporte deslizante columna cuadrada</b>   Square column shower holder
9908 0231	<b>Soporte deslizante columna Oslo</b>   Oslo column sliding shower holder
9908 0367	<b>Soporte deslizante columna Oslo Negro</b>   Black Oslo column sliding shower holder
9908 0366	<b>Soporte columna Oslo Negro</b>   Black Oslo column holder
9908 0442	<b>Soporte deslizante ducha Negro</b>   Black sliding shower holder
9908 0477	<b>Soporte deslizante ducha</b>   Sliding shower holder
9908 0478	<b>Soporte deslizante ducha</b>   Sliding shower holder



Caño  
Spout

Ref.:	Descripción   Description
68901 45	Caño alto tubo 18 cm   High tube spout 18 cm
68902 45	Caño alto tubo 24 cm   High tube spout 24 cm
68903 45	Caño tubo vertical   Swan neck spout
68904 45	Caño bajo tubo 24 cm   Low tube spout 24 cm
68911 45	Caño mural tubo recto 16 cm   Wall-mounted pipe spout 16 cm
68912 45	Caño mural tubo recto 22 cm   Wall-mounted pipe spout 22 cm
68913 45	Caño mural tubo inclinado 20 cm   Wall-mounted sloping pipe spout 20 cm
68914 45	Caño mural tubo retro 20 cm   Wall-mounted retro pipe spout 20 cm
68915 45	Caño encimera recto tubo   Straight pipe spout
68916 45	Caño encimera cisne tubo   Swan neck pipe spout
68917 45	Caño encimera inclinado tubo   Sloping pipe spout
68918 41	Caño mural tubo recto 16 cm D20   D20 wall mounted pipe spout 16 cm
68918 45	Caño mural tubo recto 16 cm D20   D20 wall mounted pipe spout 16 cm
68918 51	Caño mural tubo recto 16 cm D20   D20 wall mounted pipe spout 16 cm
68918 52	Caño mural tubo recto 16 cm D20   D20 wall mounted pipe spout 16 cm
68919 41	Caño mural tubo recto 22cm D20   D20 wall mounted pipe spout 22 cm
68919 45	Caño mural tubo recto 22cm D20   D20 wall mounted pipe spout 22 cm
68919 51	Caño mural tubo recto 22cm D20   D20 wall mounted pipe spout 22 cm
68919 52	Caño mural tubo recto 22cm D20   D20 wall mounted pipe spout 22 cm
68922 45	Caño inferior elevado   High lower spout
68924 41	Caño mural tubo recto 16 cm Negro   Black Wall mounted pipe spout 16 cm
68924 45	Caño mural tubo recto 16 cm   Wall mounted pipe spout 16 cm
68925 41	Caño mural tubo recto 22 cm Negro   Black Wall mounted pipe spout 22 cm
68925 45	Caño mural tubo recto 22 cm   Wall mounted pipe spout 22 cm
68926 45	Caño mural rectangular 16 cm   Wall mounted rectangular pipe spout 16 cm
68927 45	Caño mural rectangular 22 cm   Wall mounted rectangular pipe spout 22 cm
68928 45	Caño mural tubo recto 16 cm D20   D 20 Wall mounted pipe spout 16 cm
68929 45	Caño mural tubo recto 22 cm D20   D 20 Wall mounted pipe spout 22 cm
9908 0253	Caño para 65212 18 45 66   Spout for 65212 18 45 66
9908 0290	Caño mural tubo recto 16 cm D20 Negro   Black D20 wall mounted pipe spout 16 cm
9908 0291	Caño mural tubo recto 22 cm D20 Negro   Black D20 wall mounted pipe spout 22 cm
9908 0382	Caño conformado vertical   Vertical tube spout
9908 0383	Caño conformado   Tube spout
9908 0384	Caño conformado corto   Short tube spout
1699 45 00	Brazo pared redondo 12 cm   Round wall arm 12 cm





**Atomizador  
(Aireador)**  
Aerator

Ref.:	Descripción   Description
100025 41	<b>Aireador M16,5x1 antivandálico 5 Litros</b>   M16,5x1 Antivandal aerator 5 liters
100025 45	<b>Aireador M16,5x1 antivandálico 5 Litros</b>   M16,5x1 Antivandal aerator 5 liters
100025 51	<b>Aireador M16,5x1 antivandálico 5 Litros</b>   M16,5x1 Antivandal aerator 5 liters
100025 52	<b>Aireador M16,5x1 antivandálico 5 Litros</b>   M16,5x1 Antivandal aerator 5 liters
100065 41	<b>Aireador H18x1 antical economizador 5 litros</b>   F18x1 Anti-lime economizer aerator 5 liters
100065 45	<b>Aireador H18x1 antical economizador 5 litros</b>   F18x1 Anti-lime economizer aerator 5 liters
100065 51	<b>Aireador H18x1 antical economizador 5 litros</b>   F18x1 Anti-lime economizer aerator 5 liters
100065 52	<b>Aireador H18x1 antical economizador 5 litros</b>   F18x1 Anti-lime economizer aerator 5 liters
100066 45	<b>Aireador M18 x 1 antical</b>   M18 x 1 anti-lime aerator
100072 45	<b>Aireador M24 x 1 antical antivandálico</b>   M24 x 1 Antivandal anti-lime aerator
100073 43	<b>Aireador H22x1 antical bronce retro</b>   F22x1 bronze anti-lime retro aerator
100073 45	<b>Aireador H22x1 antical retro</b>   F22x1 anti-lime retro aerator
100074 45	<b>Aireador M24x1 antical economizador 8,5 litros</b>   M24x1 Economizer anti-lime 8.5 liters aerator
100078 45	<b>Aireador H22 x 1 antical economizador (blister 2 u.)</b>   F22 x 1 Economizer anti-lime aerator (blister 2 u.)
100079 41	<b>Aireador M12x1 antical con rótula</b>   M12x1 anti-lime aerator w/kneecap
100079 45	<b>Aireador M12x1 antical con rótula</b>   M12x1 anti-lime aerator w/kneecap
100079 51	<b>Aireador M12x1 antical con rótula</b>   M12x1 anti-lime aerator w/kneecap
100079 52	<b>Aireador M12x1 antical con rótula</b>   M12x1 anti-lime aerator w/kneecap
100080 45	<b>Aireador para 65203 18 45 66</b>   65203 18 45 66 aerator
100082 45	<b>Aireador 2 salidas antical</b>   Double flow anti-lime aerator
100082 41	<b>Aireador 2 salidas antical Negro</b>   Black Double flow anti-lime aerator
100082 44	<b>Aireador 2 salidas antical a.Inox</b>   SS F. Double flow anti-lime aerator
100083 41	<b>Aireador M28x1 antical Negro</b>   Black M28x1 anti-lime aerator
100083 43	<b>Aireador M28x1 antical bronce</b>   M28x1 anti-lime bronze aerator
100083 45	<b>Aireador M28x1 antical</b>   M28x1 anti-lime aerator
100085 41	<b>Aireador M24x1 antical</b>   M24x1 anti-lime aerator
100085 43	<b>Aireador M24x1 antical bronce</b>   M24x1 anti-lime bronze aerator
100085 45	<b>Aireador M24x1 antical</b>   M24x1 anti-lime aerator
100085 51	<b>Aireador M24x1 antical</b>   M24x1 anti-lime aerator
100085 52	<b>Aireador M24x1 antical</b>   M24x1 anti-lime aerator
100086 43	<b>Aireador M24x1 antical con rótula bronce</b>   M24x1 bronze anti-lime aerator w/ kneecap
100086 45	<b>Aireador M24 x 1 antical con rótula</b>   M24 x 1 anti-lime aerator w/ kneecap
100088 45	<b>Aireador H22x1 antical</b>   F22x1 anti-lime aerator
100089 45	<b>Aireador H18 x 1 antical</b>   F18 x 1 aerator anti-lime
9908 0026	<b>Aireador para caño rectangular</b>   Rectangular spout aerator
9908 0043	<b>Aireador para 65203 18 60 66</b>   65203 18 60 66 aerator
9908 0044	<b>Aireador para 65208 18 60 66</b>   65208 18 60 66 aerator
9908 0216	<b>Aireador M24x1 antical Blanco</b>   White M24x1 anti-lime aerator
9908 0242	<b>Aireador H18x1 antical Blanco</b>   White F18x1 anti-lime aerator
9908 0244	<b>Aireador H18x1 antical Negro</b>   Black F18x1 anti-lime aerator
9908 0267	<b>Aireador antivandálico orientable</b>   Antivandal orientable aerator



**Atomizador  
(Aireador)**  
Aerator

Ref.:	Descripción   Description
9908 0268	<b>Aireador antivandálico</b>   Antivandal aerator
9908 0279	<b>Aireador M18x1 antical</b>   M18x1 anti-lime aerator
9908 0281	<b>Aireador M24x1 antical con rótula Negro</b>   Black M24x1 anti-lime aerator w/kneecap
9908 0322	<b>Aireador H22x1 antical Negro</b>   Black F22x1 anti-lime aerator
9908 0351	<b>Aireador H18x1 antical INOX</b>   SS F18X1 anti-lime aerator
9908 0378	<b>Aireador H28x1 antical Negro</b>   Black F28X1 ant-lime aerator
9908 0388	<b>Aireador H18x1 antical a. INOX</b>   F. SS F18x1 anti-lime aerator
9908 0391	<b>Aireador M24X1 antical a. INOX</b>   F. SS M24X1 anti-lime aerator
9908 0433	<b>Aireador H22x1 antical</b>   F22x1 anti-lime aerator
9908 0434	<b>Aireador M18x1 antical economizador 5 litros</b>   M18x1 anti-lime economizer aerator 5 liters
9908 0479	<b>Aireador H28x1 antical</b>   F28X1 ant-lime aerator
9908 0480	<b>Aireador H28x1 antical</b>   F28X1 ant-lime aerator
9908 0486	<b>Aireador H28x1 antical</b>   F28X1 ant-lime aerator



**Cartucho**  
Cartridge

100036	<b>Cartucho cerámico D35 salida libre 2 posiciones</b>   2 Positions free flow D35 ceramic cartridge
100037	<b>Cartucho termostático</b>   Thermostatic mixer cartridge
100042	<b>Cartucho cerámico D25 convencional 1 agua</b>   1 water conventional D25 ceramic cartridge
100044	<b>Cartucho cerámico D25 convencional</b>   Conventional D25 ceramic cartridge
100045	<b>Cartucho cerámico D40 convencional 2 posiciones</b>   2 positions conventional D40 ceramic cartridge
100046	<b>Cartucho cerámico progresivo</b>   Progressive ceramic cartridge
100047	<b>Cartucho termóstatico D24</b>   D24 thermostatic cartridge
100048	<b>Cartucho cerámico D40 salida libre 2 posiciones</b>   2 positions free flow D40 ceramic cartridge
100049	<b>Cartucho cerámico D40 convencional</b>   Conventional D40 ceramic cartridge
100051	<b>Cartucho cerámico D40 salida libre</b>   Free flow D40 ceramic cartridge
100053	<b>Cartucho cerámico D35 convencional</b>   Conventional D35 ceramic cartridge
100054	<b>Cartucho cerámico D35 salida libre</b>   Free flow D35 ceramic cartridge
100058	<b>Cartucho cerámico 2 vías</b>   2-way ceramic cartridge
100064	<b>Cartucho cerámico D40 junta superior salida libre 2 posiciones</b>   2 positions free flow D40 ceramic cartridge upper gasket
9908 0051	<b>Cartucho termostático empotrada</b>   Built-in tap thermostatic mixer cartridge
9908 0332	<b>Cartucho cerámico D35 apertura frio</b>   Cold start D35 ceramic cartridge
9908 0333	<b>Cartucho cerámico D40 apertura frio</b>   Cold start D40 ceramic cartridge
9908 0374	<b>Cartucho termóstatico D24 Negro</b>   Black D24 thermostatic cartridge
9908 0452	<b>Placa llave de paso</b>   Stopcock plate
9908 0467	<b>Cartucho cerámico D25 junta superior salida libre</b>   Free flow D25 ceramic cartridge upper gasket



**Montura**  
Headwork

Ref.:	Descripción   Description
67895 45	<b>Montura cerámica larga</b>   Ceramic long headwork
67896 45	<b>Montura convencional larga</b>   Conventional long headwork
67897 45	<b>Montura cerámica apertura derecha</b>   Clockwise opening ceramic headwork
67898 45	<b>Montura cerámica larga apertura derecha</b>   Clockwise opening long ceramic headwork
67995 14	<b>Montura cerámica termostática</b>   Thermostatic ceramic headwork
67997 45	<b>Montura cerámica agua filtrada apertura derecha</b>   Clockwise opening filtered water ceramic headwork
67998 45	<b>Montura cerámica agua filtrada</b>   Ceramic headwork filtered water
68995 09	<b>Montura cerámica</b>   Ceramic headwork
68995 11	<b>Montura convencional</b>   Conventional headwork
9908 0238	<b>Montura cerámica para termostática Oslo</b>   Oslo thermostatic ceramic headwork
9908 0450	<b>Montura cerámica para llave de paso 1/2"</b>   1/2" stopcock ceramic headwork
9908 0454	<b>Montura cerámica para llave de paso 3/4"</b>   3/4" stopcock ceramic headwork



**Inversor**  
Diverter

100069	<b>Inversor cerámico columna termostática</b>   Thermostatic column ceramic diverter
100117 45	<b>Inversor compacto Oslo</b>   Oslo compact diverter
100157 45	<b>Inversor Kelogic</b>   Kelogic diverter
100158 45	<b>Inversor termostático Kenjo</b>   Kenjo thermostatic diverter
100160 41	<b>Inversor latón Negro</b>   Black brass diverter
100160 45	<b>Inversor ABS cromo</b>   ABS chromed diverter
100161 45	<b>Inversor botón</b>   Button diverter
100162 45	<b>Inversor largo baño empotrado</b>   Built-in large push-button diverter
100162 41	<b>Inversor largo baño empotrado</b>   Built-in large push-button diverter
100162 51	<b>Inversor largo baño empotrado</b>   Built-in large push-button diverter
100162 52	<b>Inversor largo baño empotrado</b>   Built-in large push-button diverter
100164 45	<b>Inversor compacto Tau</b>   Tau compact diverter
100165 45	<b>Inversor para termostático Klip</b>   Klip thermostatic diverter
100173 45	<b>Inversor cerámico largo baño empotrado</b>   Built-in large push-button diverter
100174 45	<b>Inversor convencional para batería bidet</b>   Bidet set conventional diverter
100180 41	<b>Inversor compacto Kloe</b>   Kloe compact diverter
100180 45	<b>Inversor compacto Kloe</b>   Kloe compact diverter
100180 51	<b>Inversor compacto Kloe</b>   Kloe compact diverter
100180 52	<b>Inversor compacto Kloe</b>   Kloe compact diverter
51745 45	<b>Inversor columna redonda</b>   Round column diverter
51746 45	<b>Inversor columna cuadrada</b>   Square column diverter
9908 0024	<b>Inversor cerámico 2 vías</b>   2 way ceramic diverter
9908 0025	<b>Inversor cerámico 3 vías</b>   3 way ceramic diverter
9908 0052	<b>Inversor cerámico termostática 2 vías</b>   2 way thermostatic tap ceramic diverter
9908 0054	<b>Inversor cerámico termostática 3 vías</b>   3 way thermostatic tap ceramic diverter
9908 0081	<b>Inversor monomando bidé</b>   Single lever bidet diverter
9908 0204	<b>Inversor set columna</b>   Column set diverter
9908 0221	<b>Inversor columna monomando</b>   Single handle column diverter





**Inversor**  
Diverter

Ref.:	Descripción   Description
9908 0233	<b>Inversor cerámico columna Oslo</b>   Oslo column ceramic diverter
9908 0237	<b>Inversor columna Oslo</b>   Oslo column diverter
9908 0247	<b>Inversor para 62119 31 45 66</b>   Diverter for 62119 31 45 66
9908 0249	<b>Inversor para 63119 26 45 66</b>   Diverter for 63119 26 45 66
9908 0252	<b>Inversor para 65212 18 45 66</b>   Diverter for 65212 18 45 66
9908 0288	<b>Inversor compacto Oslo Negro</b>   Black Oslo compact diverter
9908 0326	<b>Inversor Negro</b>   Black Diverter
9908 0334	<b>Inversor cerámico 2 vías</b>   2 way ceramic diverter
9908 0335	<b>Inversor cerámico 3 vías</b>   3 way ceramic diverter
9908 0369	<b>Inversor columna Oslo Negro</b>   Black Oslo column diverter
9908 0372	<b>Inversor cerámico</b>   Ceramic diverter



**Conexiones**  
Connections

100012	<b>Conexión DN6 10x1 - 15x1 a 15 cm</b>   10x1 - 15x1 15 cm DN6 connection
100014	<b>Juego de conexiones DN6 8x1 - H 3/8" a 50 cm</b>   8x1 - F 3/8" 50 cm DN6 connection set
100100	<b>Juego de conexiones 10 x 1 - H 3/8" a 55 cm</b>   10 x 1 - F 3/8" 55 cm connection set
100101	<b>Conexión PEX 10x1 - H 3/8" a 15 cm</b>   10x1 - F 3/8" 15 cm PEX connection
100103	<b>Juego de conexiones 10x1 x H 3/8" a 35 cm</b>   10x1 - F 3/8" 35 cm connection set
100104	<b>Conexión PVC 10x1 - H 3/8" a 60 cm</b>   10x1 - F 3/8" 60 cm PVC connection
100105	<b>Juego de conexiones 10x1 - H 3/8" a 40 cm</b>   10x1 - F 3/8" 40 cm connection set
100111	<b>Juego de conexiones 10x1 - H 1/2" a 40 cm</b>   10x1 - F 1/2" 40 cm connection set
100113	<b>Juego de conexiones DN6 10x1 - H 3/8" a 35 cm</b>   10x1 - F 3/8" 35 cm DN6 connection set
100118	<b>Juego de conexiones 10x1 - 15x1 a 15 cm</b>   10x1 - 15x1 15 cm connection set
100129	<b>Juego de conexiones 10x1 - H 3/8" a 60 cm</b>   10x1 - F 3/8" 60 cm connection set
9908 0270	<b>Conector 3/8" tubo 1/4"</b>   Fitting 3/8" pipe 1/4"



**Conjunto sujeción**  
Fixation set

100090	<b>Conjunto sujeción</b>   Fixation set
100091	<b>Conjunto sujeción 2 tornillos</b>   2 screws fixation set
100092	<b>Conjunto sujeción</b>   Fixation set
100095	<b>Conjunto sujeción Kenjo</b>   Kenjo fixation set
100097	<b>Conjunto sujeción fregadera extraíble</b>   Pull-out sink tap fixation set
100098	<b>Conjunto sujeción 1/2"</b>   1/2" Fixation set
9908 0042	<b>Conjunto sujeción M32</b>   M32 fixation set
9908 0047	<b>Conjunto sujeción lavabo Oslo</b>   Oslo basin fixation set
9908 0048	<b>Conjunto sujeción lavabo medio alto Oslo</b>   Oslo medium high basin fixation set
9908 0049	<b>Conjunto sujeción lavabo alto Oslo</b>   Oslo high basin fixation set
9908 0050	<b>Conjunto sujeción bidé Oslo</b>   Oslo bidet fixation set
9908 0064	<b>Conjunto Sujeción</b>   Fixation set
9908 0264	<b>Conjunto sujeción 61200</b>   61200 fixation set
9908 0265	<b>Conjunto sujeción 120 M8</b>   120 M8 fixation set
9908 0266	<b>Conjunto sujeción FRK</b>   FRK fixation set
9908 0271	<b>Conjunto Sujeción para 65700 18 45 66</b>   Fixation set for 65700 18 45 66
9908 0453	<b>Conjunto sujeción llave de paso</b>   Stopcock fixation set
9908 0468	<b>Conjunto sujeción M28</b>   M28 fixation set

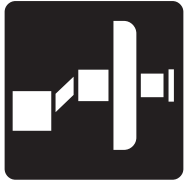

**Conjunto excéntrica**  
Eccentric set

Ref.:	Descripción   Description
100114 45	<b>Conjunto florón y excéntricas oval</b>   Oval scutcheon and eccentric set
100125 43	<b>Conjunto florón y excéntricas bronce</b>   Bronze scutcheon and eccentric set
100125 45	<b>Conjunto florón y excéntricas</b>   Scutcheon and eccentric set
100126 41	<b>Conjunto florón y excéntricas Redondo D60</b>   Round D60 scutcheon and eccentric set
100126 45	<b>Conjunto florón y excéntricas redondo D60</b>   Round D60 scutcheon and eccentric set
100126 51	<b>Conjunto florón y excéntricas Redondo D60</b>   Round D60 scutcheon and eccentric set
100126 52	<b>Conjunto florón y excéntricas Redondo D60</b>   Round D60 scutcheon and eccentric set
100127 45	<b>Conjunto florón y excéntricas redondo D65</b>   Round D65 scutcheon and eccentric set
100128 45	<b>Conjunto florón y excéntricas cuadrado</b>   Square scutcheon and eccentric set
51744 45	<b>Cuerpo inversor set Oslo</b>   Oslo set diverter body
51744 41	<b>Cuerpo inversor set Oslo Negro</b>   Black Oslo set diverter body
568113 45	<b>Batería de baño con inversor</b>   Widespread bath mixer with diverter
568115 45	<b>Grupo ducha empotrado 8"</b>   Built-in 8" shower mixer
568116 45	<b>Grupo baño empotrado 8" con inversor</b>   Built-in 8" bath mixer with diverter
568120 45	<b>Batería de lavabo</b>   Widespread wash-basin mixer
568131 45	<b>Grupo de lavabo empotrado</b>   Built-in wash-basin mixer
568142 45	<b>Batería de bidé con transmisión</b>   Widespread bidet mixer with transmission
568170 45	<b>Llave de paso 1/2"</b>   Stopcock 1/2"
5CM63110 45	<b>Cuerpo monomando columna cuadrada</b>   Square single handle column body
5CM64111 45	<b>Cuerpo monomando columna Koral</b>   Koral column single handle body
5CM65110 45	<b>Cuerpo monomando columna redonda</b>   Round column single handle body
5CM65111 45	<b>Cuerpo monomando columna Oslo</b>   Oslo column single lever mixer body
5CM65111 41	<b>Cuerpo monomando columna Oslo</b>   Oslo column single lever mixer body
5CT63110 45	<b>Cuerpo termostático columna Kenjo</b>   Kenjo column thermostatic mixer body
5CT65110 45	<b>Cuerpo termostático columna Tau</b>   Tau column thermostatic mixer body
5CT65111 45	<b>Cuerpo termostático columna Oslo</b>   Oslo column thermostatic mixer body
5CT67111 41	<b>Cuerpo termostático columna Oslo</b>   Oslo column thermostatic mixer body
9908 0202	<b>Racord columna Kenjo</b>   Kenjo column conector
9908 0345	<b>Racord para CT67110 26</b>   CT67110 26 column conector
9908 0458	<b>Racord mezclador sanitario</b>   Sanitary mixer conector
9908 0462	<b>Racord mezclador sanitario Negro</b>   Black sanitary mixer conector
9908 0473	<b>Racord mezclador sanitario</b>   Sanitary mixer conector
9908 0474	<b>Racord mezclador sanitario</b>   Sanitary mixer conector
65116 19 45 66	<b>Monomando empotrado con inversor 2 vías</b>   2 way Built-in single lever mixer with diverter
5CM64111 41	<b>Cuerpo monomando columna Koral Negro</b>   Black Koral column single handle body



**Cuerpo**  
Body



Placa  
Tap plate

Ref.:	Descripción   Description
9908 0053	Placa termostática empotrada 2 vías   Built-in 2 way thermostatic mixer plate
9908 0228	Placa lavabo ovalada D35 Negra   Black D35 oval basin mixer plate
9908 0323	Placa de lavabo empotrado Negro   Black Built-in basin mixer plate
9908 0327	Placa ducha empotrada Negro   Black Built-in shower mixer plate
9908 0328	Placa baño/ducha empotrado Negro   Black Built-in bath/shower mixer plate
9908 0329	Placa de empotrada 2 vías Negra   Black Built-in 2 way plate
9908 0330	Placa de empotrada 3 vías Negra   Black Built-in 3 way plate
9908 0331	Placa inversor cerámico Negra   Black Built-in ceramic diverter plate
9908 0341	Placa ducha empotrada Negra   Black Built-in shower mixer plate
9908 0342	Placa baño/ducha empotrado Negro   Black Built-in bath/shower mixer plate
9908 0444	Placa llave de paso Negra   Black Stopcock plate
9908 0456	Placa mezclador sanitario   Sanitary mixer plate
9908 0460	Placa mezclador sanitario Negro   Black sanitary mixer plate
9908 0471	Placa mezclador sanitario   Sanitary mixer plate
9908 0472	Placa mezclador sanitario   Sanitary mixer plate
9908 0483	Placa llave de paso   Stopcock plate
9908 0484	Placa llave de paso   Stopcock plate
PB115 40 45	Placa redonda para empotrada   Built-in round plate
PB117 40 45	Placa redonda empotrada 2 vías   Built-in 2 way round plate
PB118 40 45	Placa redonda empotrada 3 vías   Built-in 3 way round plate
PC0115 35 41	Placa ducha empotrada   Built-in 1 way plate
PC0115 35 45	Placa ducha empotrada   Built-in 1 way plate
PC0115 35 51	Placa ducha empotrada   Built-in 1 way plate
PC0115 35 52	Placa ducha empotrada   Built-in 1 way plate
PC0116 35 41	Placa empotrada 2 vías   Built-in shower mixer plate
PC0116 35 45	Placa empotrada 2 vías   Built-in shower mixer plate
PC0116 35 51	Placa empotrada 2 vías   Built-in shower mixer plate
PC0116 35 52	Placa empotrada 2 vías   Built-in shower mixer plate
PC0131 35 41	Placa lavabo empotrado   Built-in basin mixer plate
PC0131 35 45	Placa lavabo empotrado   Built-in basin mixer plate
PC0131 35 51	Placa lavabo empotrado   Built-in basin mixer plate
PC0131 35 52	Placa lavabo empotrado   Built-in basin mixer plate
PC114	Placa inversor cerámico   Built-in ceramic diverter plate
PC115	Placa ducha empotrada   Built-in shower mixer plate
PC116	Placa baño/ducha empotrado   Built-in bath/shower mixer plate
PC117	Placa empotrada 2 vías   Built-in 2 way plate
PC118	Placa empotrada 3 vías   Built-in 3 way plate
PC131	Placa lavabo empotrado   Built-in basin mixer plate
PK115	Placa ducha empotrada   Built-in shower mixer plate
PK116	Placa baño/ducha empotrado   Built-in bath/shower mixer plate
PK131	Placa lavabo caño cuadrado   Square spout basin plate





**Placa**  
Tap plate

Ref.:	Descripción   Description
PL115	<b>Placa ducha empotrada</b>   Built-in shower mixer plate
PL116	<b>Placa baño/ducha empotrado</b>   Built-in bath/shower mixer plate
PL131	<b>Placa lavabo ovalada D35</b>   D35 oval basin mixer plate
PO113	<b>Placa inversor ovalada</b>   Diverter oval plate
PO115	<b>Placa ovalada ducha empotrada</b>   Built-in shower mixer plate
PO117	<b>Placa ovalada empotrada 2 vías</b>   Built-in 2 way oval plate
PO118	<b>Placa ovalada empotrada 3 vías</b>   Built-in 3 way oval plate
PO131	<b>Placa lavabo ovalada</b>   Oval basin plate
PR113	<b>Placa inversor redonda</b>   Diverter round plate
PS115	<b>Placa ducha empotrada</b>   Built-in shower mixer plate
PS116	<b>Placa baño/ducha empotrado</b>   Built-in bath/shower mixer plate
PT113	<b>Placa inversor cuadrada</b>   Diverter square plate
PT115	<b>Placa ducha empotrada</b>   Built-in shower tap plate
PT116	<b>Placa baño/ducha empotrado</b>   Built-in bath/shower mixer plate
PT117	<b>Placa rectangular empotrada 2 vías</b>   Built-in 2 way rectangular plate
PT118	<b>Placa rectangular inversor empotrada 3 vías</b>   Built-in 3 way rectangular plate
PT131	<b>Placa lavabo rectangular</b>   Rectangular basin mixer plate



**Set juntas**  
Gasket sets

9908 0063	<b>Set juntas montura convencional</b>   Join set conventional headwork
9908 0074	<b>Set de juntas para 61900 28 45 66</b>   Gasket set for 61900 28 45 66
9908 0075	<b>Set de juntas para 65900 18 45 66</b>   Gasket set for 65900 18 45 66
9908 0152	<b>Set de juntas serie A</b>   A series gasket set
9908 0153	<b>Set de juntas serie B</b>   B series gasket set
9908 0154	<b>Set de juntas serie C</b>   C series gasket set
9908 0200	<b>Set juntas columna redonda</b>   Round column gasket set
9908 0209	<b>Set de juntas</b>   Gasket set
9908 0210	<b>Set juntas columna cuadrada</b>   Square column gasket set
9908 0230	<b>Set juntas columna Oslo</b>   Oslo column gasket set
9908 0257	<b>Set de juntas para 65212 18 45 66</b>   Gasket set for 65212 18 45 66
9908 0261	<b>Set de juntas para 65219 18 45 66</b>   Gasket set for 65219 18 45 66
9908 0263	<b>Set de juntas para 65700 18 45 66</b>   Gasket set for 65700 18 45 66
9908 0269	<b>Set de juntas para 65215 40 60 66</b>   Gasket set for 65215 40 60 66
J100206	<b>Junta tapón V-click 1 1/2"</b>   1 1/2" V-click cap gasket
J15	<b>Set de juntas inversor monomando bidé</b>   Single lever bidet mixer diverter gasket set
J16	<b>Set de juntas R16</b>   R16 gasket set
J17	<b>Set de juntas columna extensible</b>   Extensible column gasket set
J18	<b>Set de juntas para 65203 18 60 66</b>   Gasket set for 65203 18 60 66
J19	<b>Set de juntas para 65208 18 60 66</b>   Gasket set for 65208 18 60 66
J20	<b>Set de juntas para 65211 18 60 66</b>   Gasket set for 65211 18 60 67
J61	<b>Set de juntas 61200</b>   61200 gasket set
J65	<b>Set de juntas R21</b>   R21 gasket set
J67	<b>Set de juntas 65702 18 45 66</b>   65702 18 45 66 gasket set



### Set juntas

Gasket sets

Ref.:	Descripción   Description
J68	<b>Set de juntas caño tubo</b>   Pipe spout gasket set
9908 0371	<b>Set de juntas para 65200 19 45 66</b>   Gasket set for 65200 19 45 66
9908 0394	<b>Set de juntas para FRV61208</b>   Gasket set for FRV61208
9908 0487	<b>Set de juntas</b>   Gasket set



### Muelles

Springs

9908 0155	<b>Muelle click L25</b>   L25 click spring
9908 0156	<b>Muelle click L35</b>   L35 click spring
9908 0157	<b>Muelle click L38</b>   L38 click spring



### Set retenciones

Check valve sets

9908 0011	<b>Retenciones termostáticas murales</b>   Wall thermostatic mixer check valve
9908 0012	<b>Retenciones termostáticas empotradas</b>   Built-in tap thermostatic mixer check valve
9908 0236	<b>Set de retenciones para termostáticas Oslo</b>   Oslo thermostatic mixer check valve set



### Tapones

Caps

9908 0162	<b>Tapón V-Click "Luxe"</b>   Cap V-Click "Luxe"
9908 0163	<b>Tapon V-Click Luxe Bronce</b>   Cap V-Click Luxe Bronze
9908 0164	<b>Tapón V-Click Kenjo</b>   Kenjo V-click cap
9908 0165	<b>Tapón V-click 1 1/4"</b>   1 1/4" V-click cap
9908 0166	<b>Tapón V-click 1 1/2"</b>   1 1/2" V-click cap
9908 0347	<b>Tapón V-click 1 1/2" Bronce</b>   Bronze 1 1/2" Cap V-click
9908 0348	<b>Tapon V-Click "Luxe Negro"</b>   Cap V-Click "Luxe Black"
9908 0167	<b>Tapón V-click 1 1/4"</b>   1 1/4" V-click cap
9908 0168	<b>Tapón V-click 1 1/4"</b>   1 1/4" V-click cap
9908 0350	<b>Tapon V-Click "Luxe Brushed PVD Gold"</b>   Cap V-Click "Luxe Brushed PVD Gold"
9908 0380	<b>Tapon V-Click</b>   Cap V-Click
9908 0347	<b>Tapón V-click 1 1/2" Bronce</b>   Bronze 1 1/2" Cap V-click

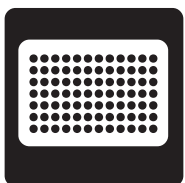

### Filtros

Filter

FT91	<b>Filtro ultrafiltración</b>   Ultrafiltration filter
FT92	<b>Filtro de clorador</b>   Dechlorinator filter

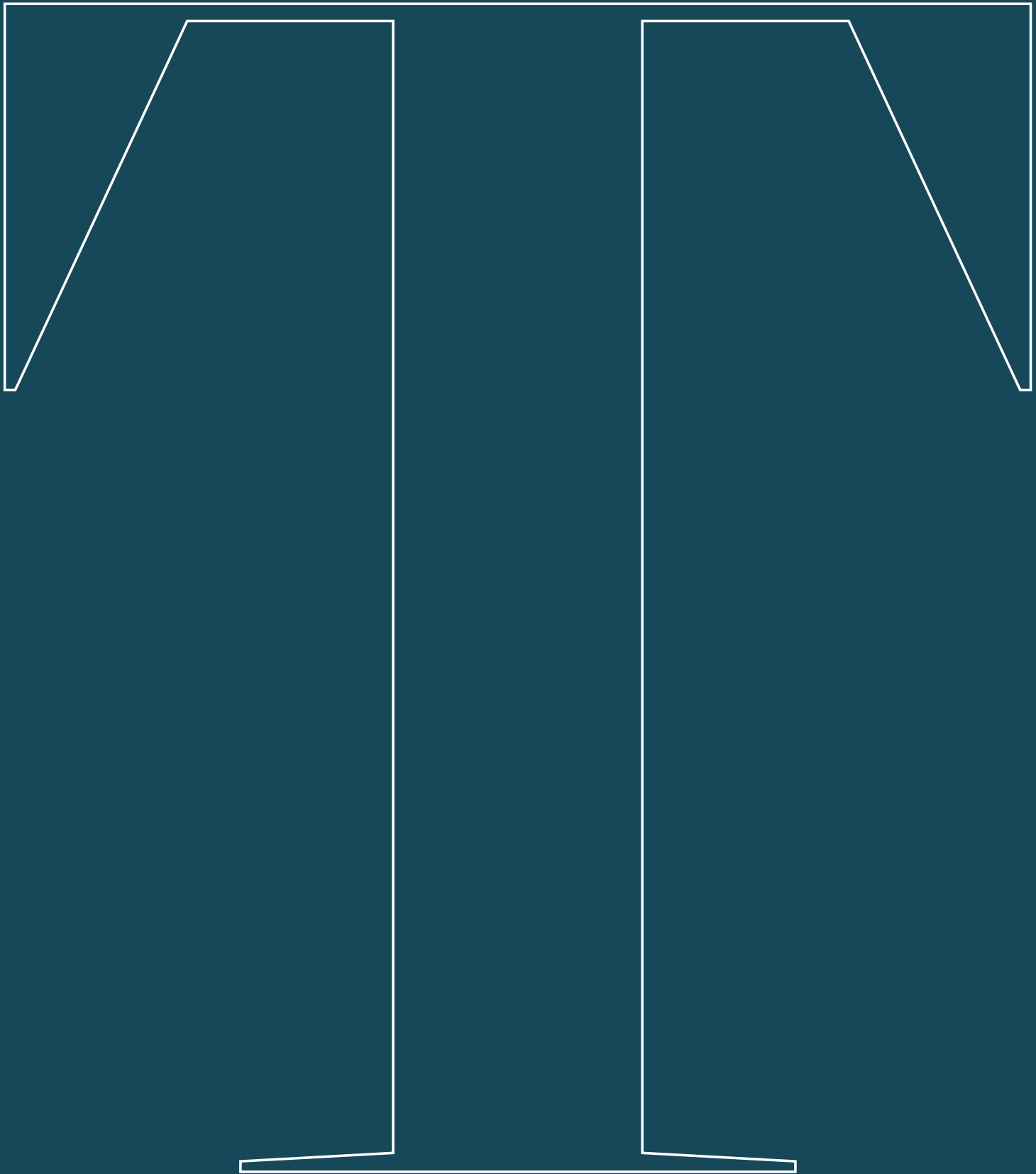



# Información técnica

Technical information

Consulta la ficha técnica de nuestros productos.

Busque la referencia del artículo y encontrará toda la información técnica necesaria referente al producto.

*Consult data sheet of our product.*

*Locate the reference article and find all the technical information regarding the product.*

## Símbolos / Symbols



**Maneta**  
Handle



**Volantes**  
Handles



**Florón**  
Scutcheon



**Duchas**  
Shower



**Flexo**  
Flexible hose



**Soporte ducha fijos**  
Fixed shower holders



**Soportes ducha deslizantes**  
Sliding shower holders



**Soporte**  
Holder



**Caño**  
Spout



**Atomizador (Aireador)**  
Aerator



**Atomizador**  
Aerator



**Cartucho**  
Cartridge



**Montura**  
Headwork



**Inversor**  
Diverter



**Conexiones**  
Connections



**Conexión flexible**  
Connection set



**Conjunto sujección**  
Fixation set



**Conjunto excéntrica**  
Eccentric set



**Cuerpo**  
Body



**Placa**  
Tap plate



**Set juntas**  
Gasket sets



**Muelles**  
Springs

## Serie Kloe

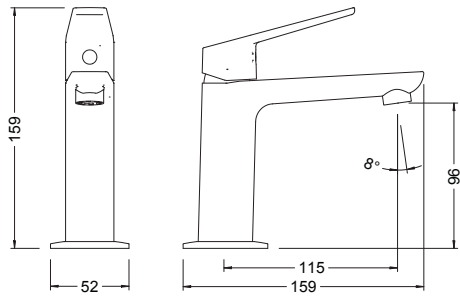

Ref.: 69130 34 45 66

Box: 1 | Carton: 12 | Pallet: 192

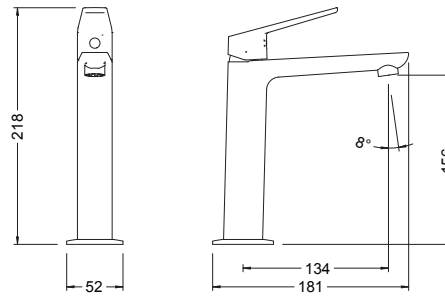
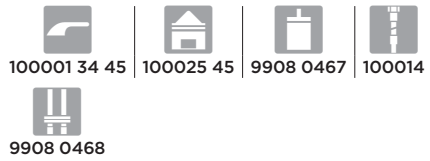

Ref.: 69134 34 45 66

Box: 1 | Carton: 6 | Pallet: 96

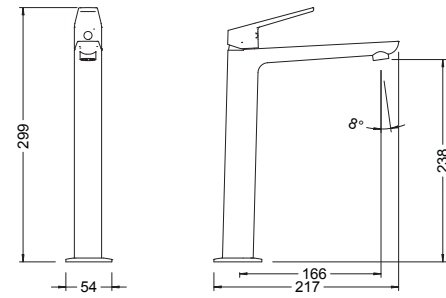
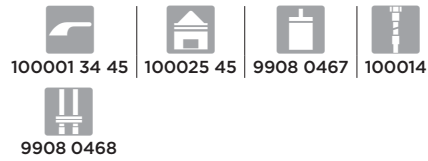

Ref.: 69136 34 45 66

Box: 1 | Carton: 10 | Pallet: 80

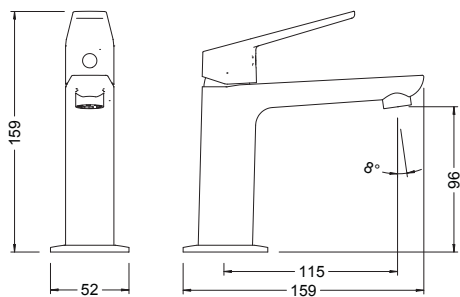
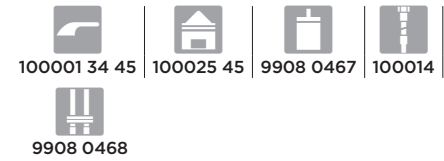

Ref.: 69130 34 41 66

Box: 1 | Carton: 12 | Pallet: 192

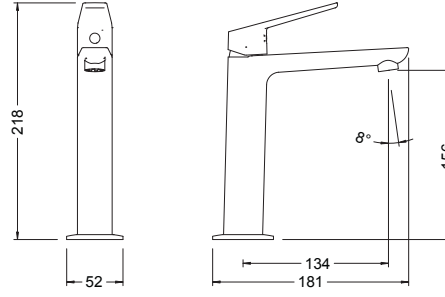
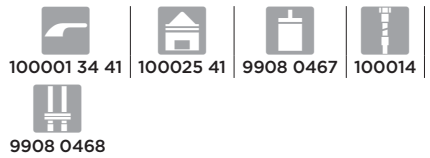

Ref.: 69134 34 41 66

Box: 1 | Carton: 6 | Pallet: 96

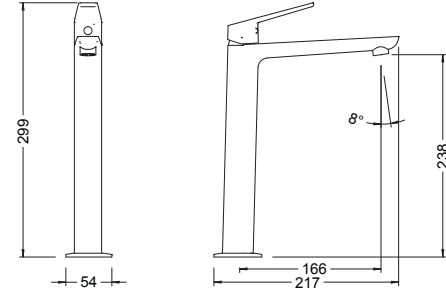
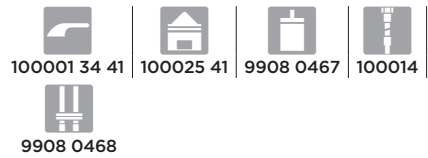

Ref.: 69136 34 41 66

Box: 1 | Carton: 10 | Pallet: 80

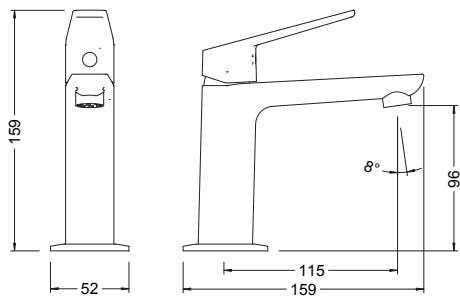
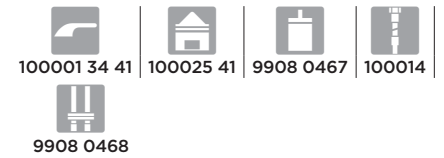

Ref.: 69130 34 51 66

Box: 1 | Carton: 12 | Pallet: 192

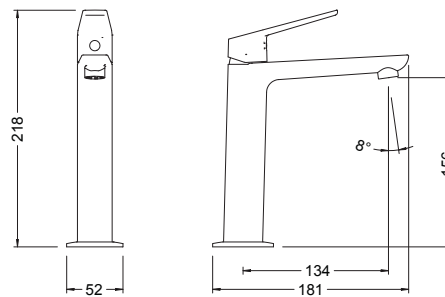

Ref.: 69134 34 51 66

Box: 1 | Carton: 6 | Pallet: 96

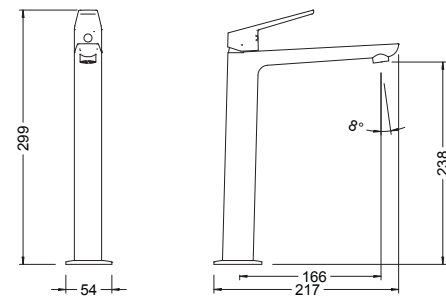
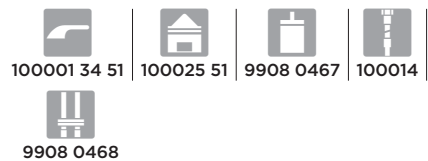

Ref.: 69136 34 51 66

Box: 1 | Carton: 10 | Pallet: 80





## Serie Kloe

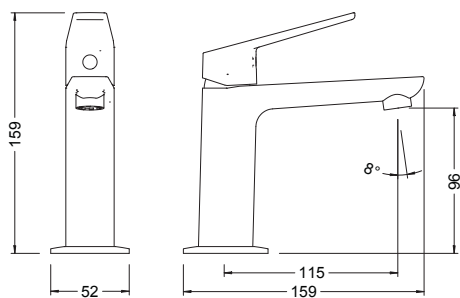

Ref.: 69130 34 52 66

Box: 1 | Carton: 12 | Pallet: 192

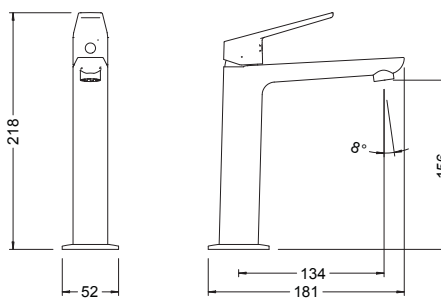
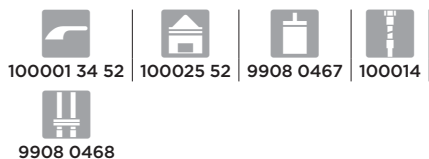

Ref.: 69134 34 52 66

Box: 1 | Carton: 6 | Pallet: 96

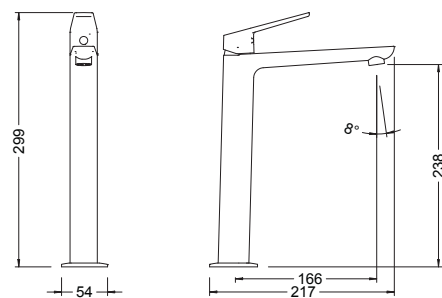

Ref.: 69136 34 52 66

Box: 1 | Carton: 10 | Pallet: 80

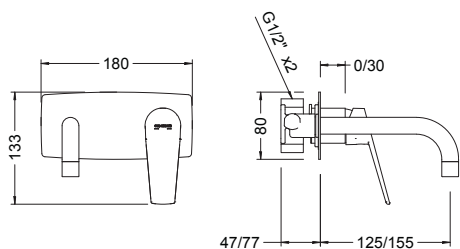
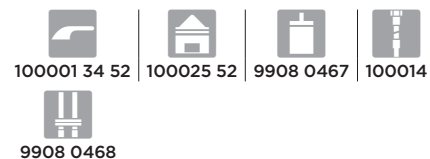

Ref.: 69131 34 45 66

Box: 1 | Carton: 6 | Pallet: 96

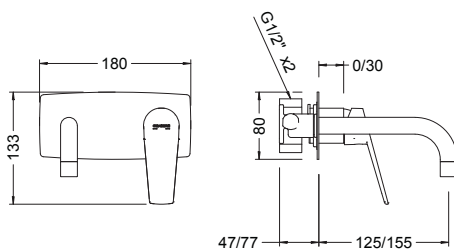

Ref.: 69131 34 41 66

Box: 1 | Carton: 6 | Pallet: 96

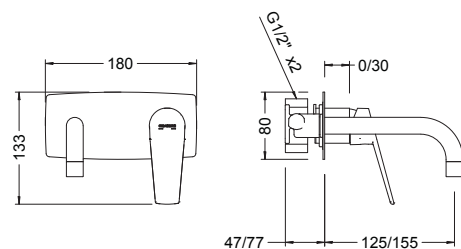

Ref.: 69131 34 51 66

Box: 1 | Carton: 6 | Pallet: 96

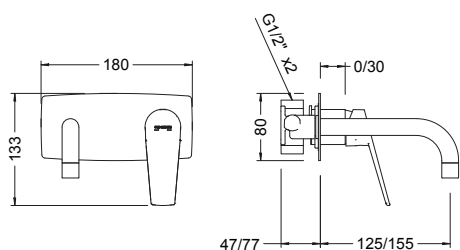
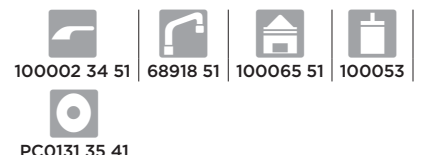

Ref.: 69131 34 52 66

Box: 1 | Carton: 6 | Pallet: 96

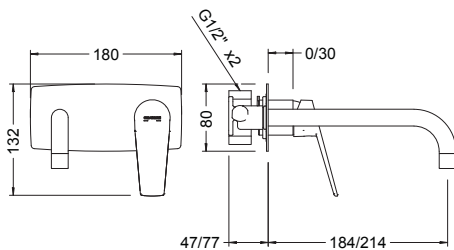
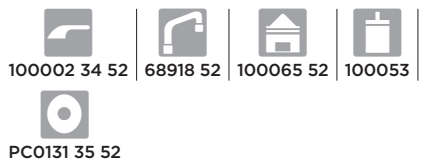

Ref.: 69132 34 45 66

Box: 1 | Carton: 6 | Pallet: 96

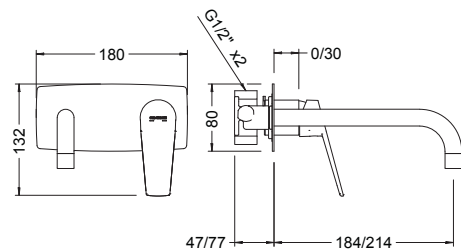

Ref.: 69132 34 41 66

Box: 1 | Carton: 6 | Pallet: 96



# Serie Kloe

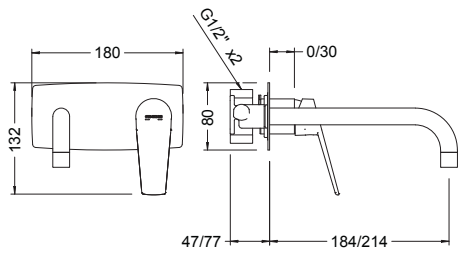

Ref.: 69132 34 51 66

Box: 1 | Carton: 6 | Pallet: 96

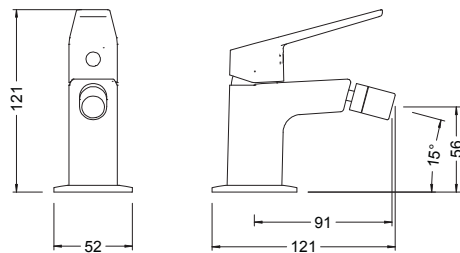

Ref.: 69140 34 41 66

Box: 1 | Carton: 12 | Pallet: 192

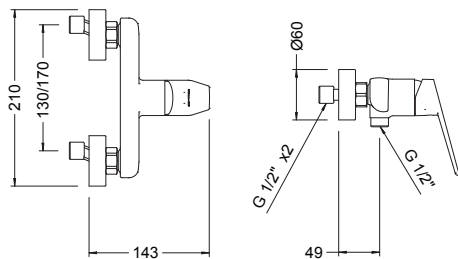

Ref.: 69110 34 45 66

Box: 1 | Carton: 8 | Pallet: 64

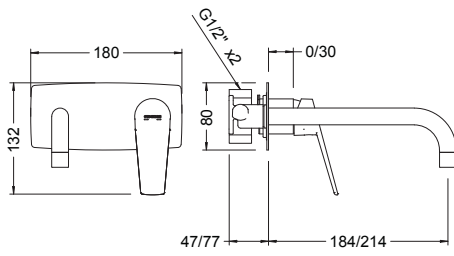

Ref.: 69132 34 52 66

Box: 1 | Carton: 6 | Pallet: 96

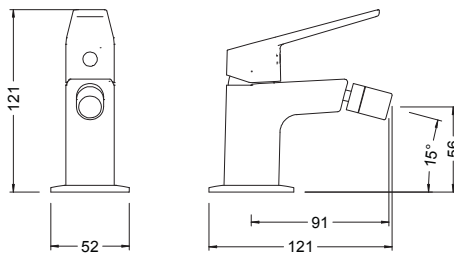

Ref.: 69140 34 51 66

Box: 1 | Carton: 12 | Pallet: 192

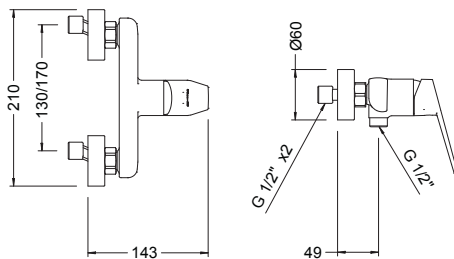

Ref.: 69110 34 41 66

Box: 1 | Carton: 8 | Pallet: 64

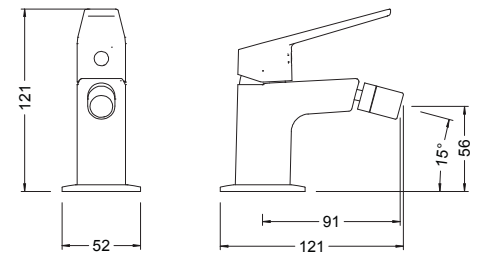

Ref.: 69140 34 45 66

Box: 1 | Carton: 12 | Pallet: 192

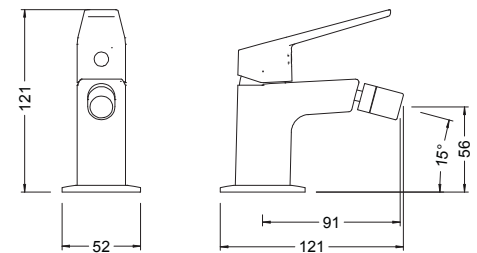

Ref.: 69140 34 52 66

Box: 1 | Carton: 12 | Pallet: 192

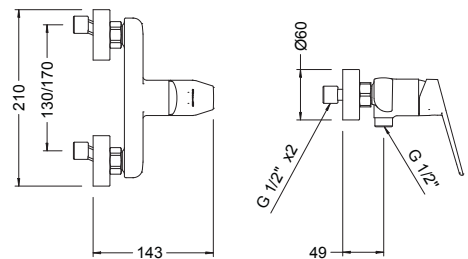

Ref.: 69110 34 51 66

Box: 1 | Carton: 8 | Pallet: 64



## Serie Kloe

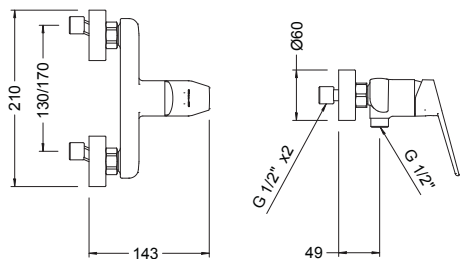

Ref.: 69110 34 52 66

Box: 1 | Carton: 8 | Pallet: 64

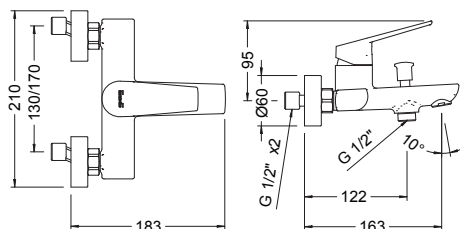
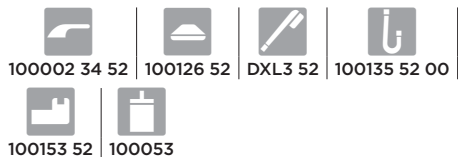

Ref.: 69100 34 52 66

Box: 1 | Carton: 8 | Pallet: 64

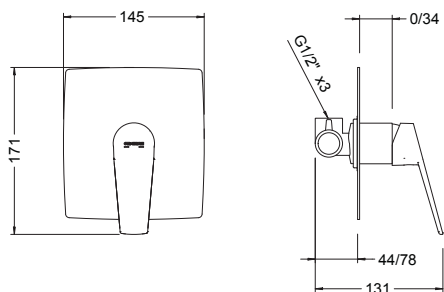

Ref.: 69115 34 41 66

Box: 1 | Carton: 12 | Pallet: 192

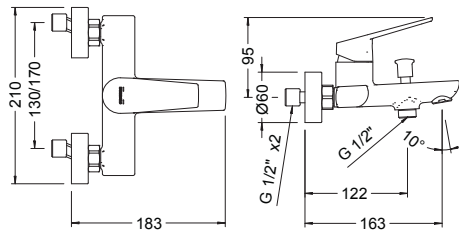

Ref.: 69100 34 45 66

Box: 1 | Carton: 8 | Pallet: 64

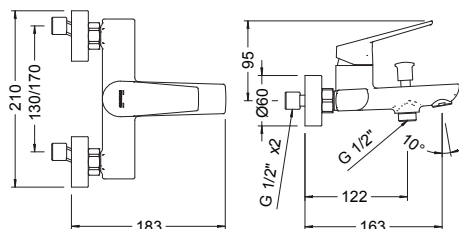
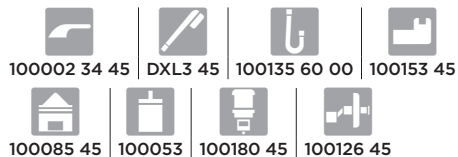

Ref.: 69100 34 52 66

Box: 1 | Carton: 8 | Pallet: 64

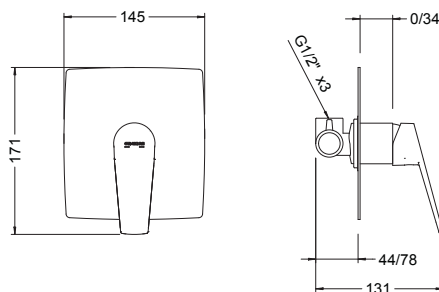

Ref.: 69115 34 52 66

Box: 1 | Carton: 12 | Pallet: 192

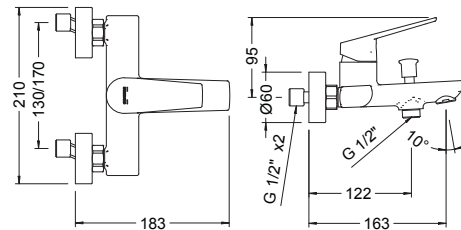

Ref.: 69100 34 41 66

Box: 1 | Carton: 8 | Pallet: 64

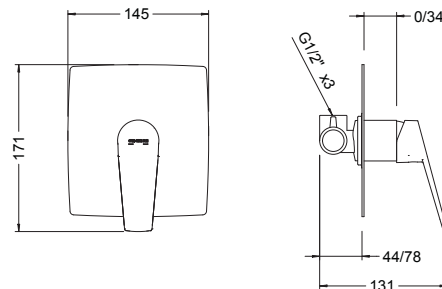
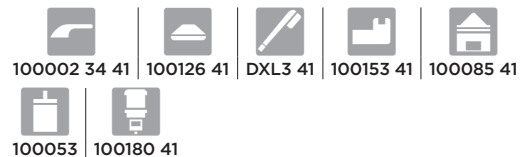

Ref.: 69115 34 45 66

Box: 1 | Carton: 12 | Pallet: 192

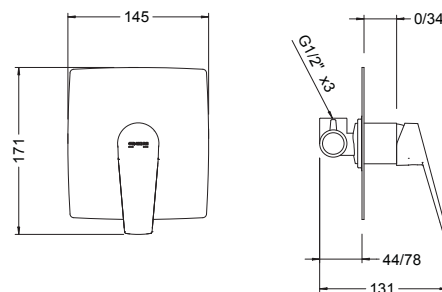

Ref.: 69115 34 51 66

Box: 1 | Carton: 12 | Pallet: 192





## Serie Kloe

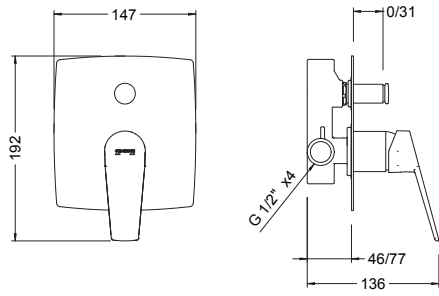

Ref.: 69116 34 45 66

Box: 1 | Carton: 6 | Pallet: 96

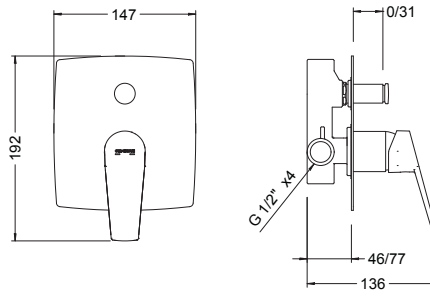

Ref.: 69116 34 41 66

Box: 1 | Carton: 6 | Pallet: 96

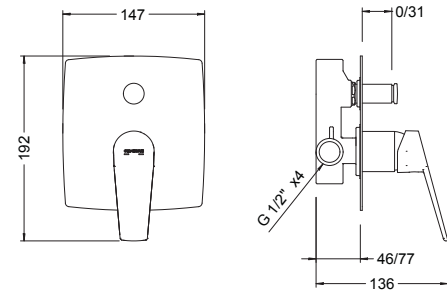

Ref.: 69116 34 51 66

Box: 1 | Carton: 6 | Pallet: 96

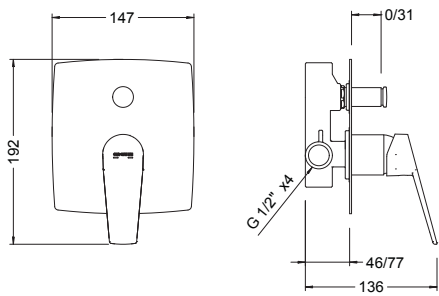

Ref.: 69116 34 52 66

Box: 1 | Carton: 6 | Pallet: 96



## Serie Koral

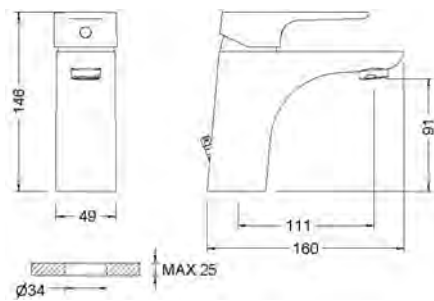

Ref.: 64150 32 45 66

Box: 1 | Carton: 12 | Pallet: 288

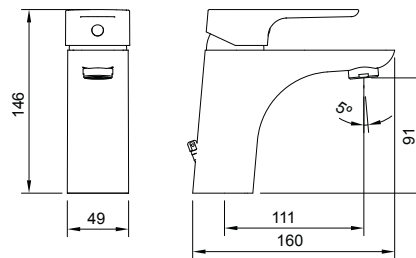

Ref.: 64130 32 45 66

Box: 1 | Carton: 12 | Pallet: 288

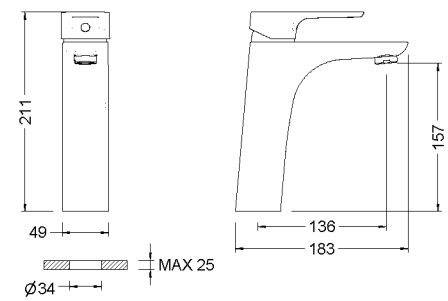

Ref.: 64134 32 45 66

Box: 1 | Carton: 10 | Pallet: 180





## Serie Koral

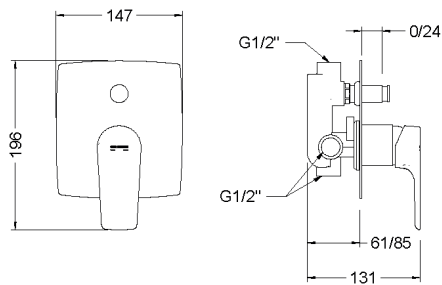

Ref.: 64116 32 45 66

Box: 1 | Carton: 12 | Pallet: 216

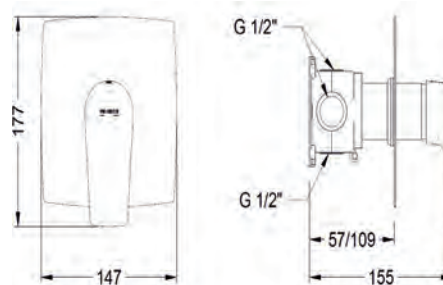

Ref.: 64316 32 45 66

Box: 1 | Carton: 12 | Pallet: 144

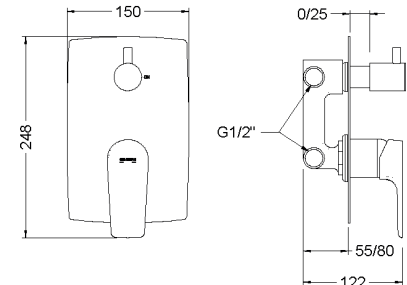

Ref.: 64117 32 45 66

Box: 1 | Carton: 6 | Pallet: 108

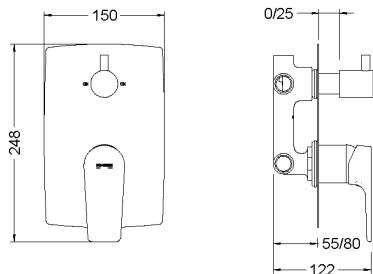
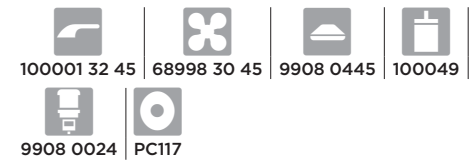

Ref.: 64118 32 45 66

Box: 1 | Carton: 6 | Pallet: 108

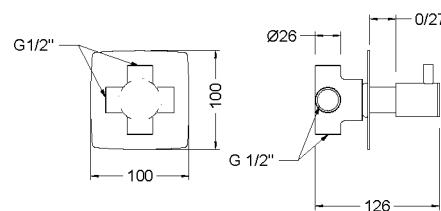
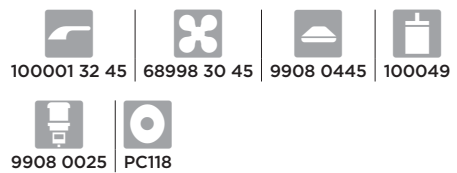

Ref.: 64114 30 45 66

Box: 1 | Carton: 8 | Pallet: 288

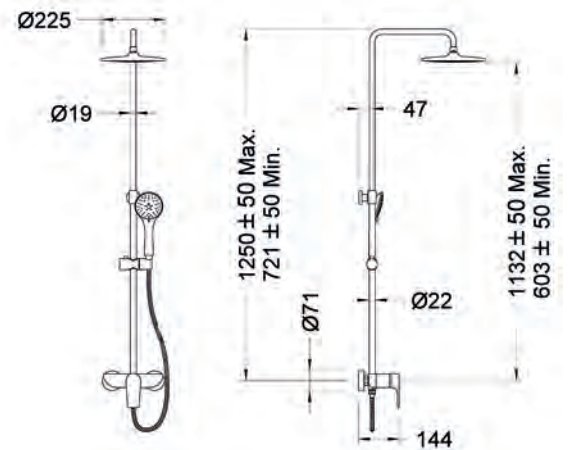

Ref.: CM64110 32

Box: 1 | Carton: 2 | Pallet: 18

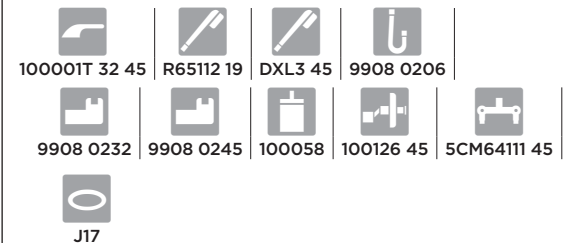



## Serie Koral Black

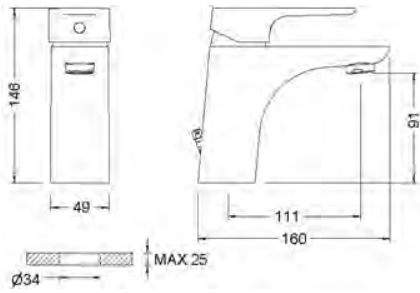

Ref.: 64130 32 41 66

Box: 1 | Carton: 12 | Pallet: 288

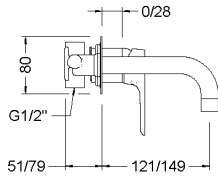

Ref.: 64131 32 41 66

Box: 1 | Carton: 7 | Pallet: 112



9908 0323

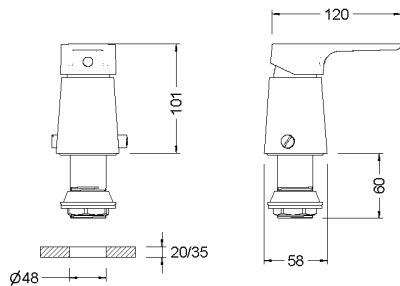

Ref.: 64142 32 41 66

Box: 1 | Carton: 10 | Pallet: 240



J15

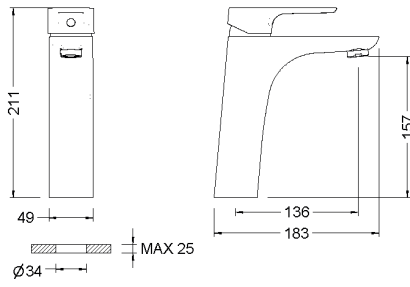

Ref.: 64134 32 41 66

Box: 1 | Carton: 9 | Pallet: 144

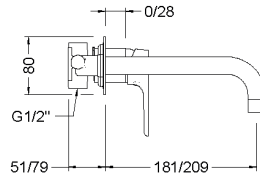

Ref.: 64132 32 41 66

Box: 1 | Carton: 7 | Pallet: 112

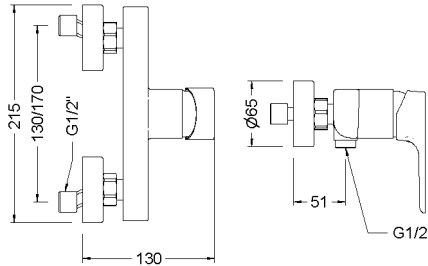

Ref.: 64110 32 41 66

Box: 1 | Carton: 8 | Pallet: 96

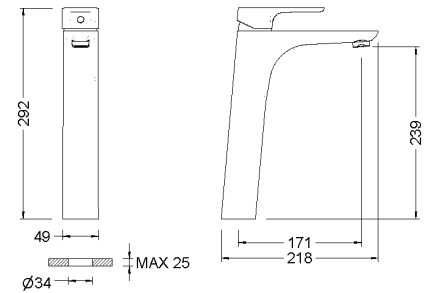

Ref.: 64136 32 41 66

Box: 1 | Carton: 9 | Pallet: 144

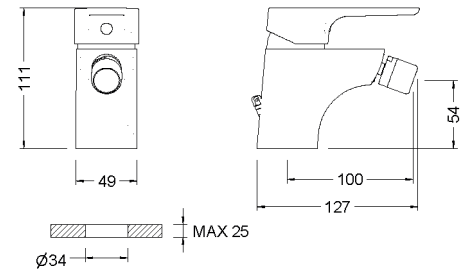

Ref.: 64140 32 41 66

Box: 1 | Carton: 17 | Pallet: 340

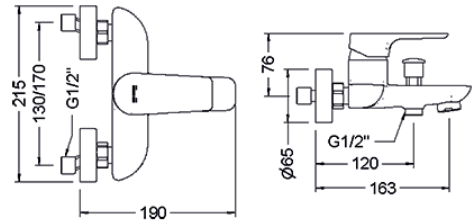

Ref.: 64100 32 41 66

Box: 1 | Carton: 8 | Pallet: 96



## Serie Koral Black

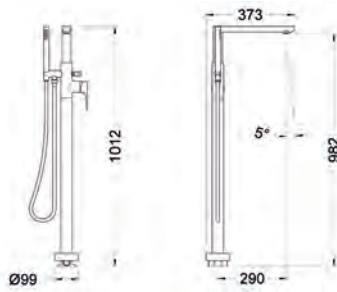

Ref.: 64119 32 41 66

Box: 1 | Carton: 2 | Pallet: 8

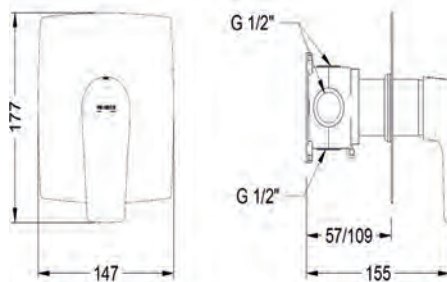

Ref.: 64316 32 41 66

Box: 1 | Carton: 12 | Pallet: 144

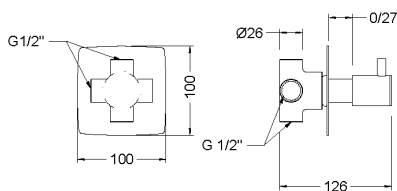

Ref.: 64114 30 41 66

Box: 1 | Carton: 22 | Pallet: 264

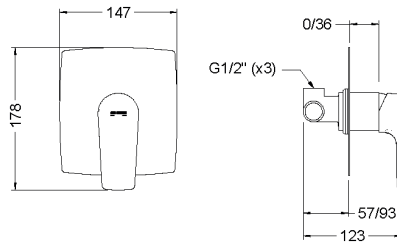

Ref.: 64115 32 41 66

Box: 1 | Carton: 12 | Pallet: 192

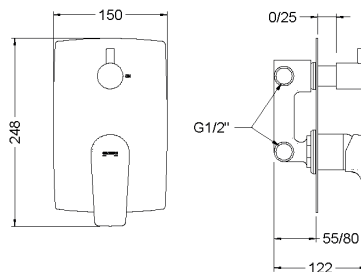

Ref.: 64117 32 41 66

Box: 1 | Carton: 9 | Pallet: 108

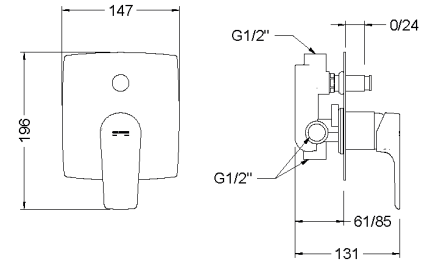
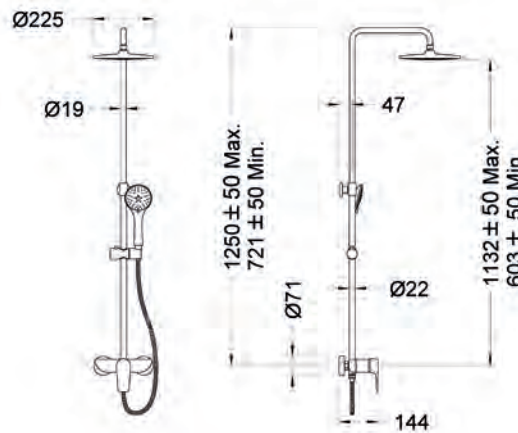
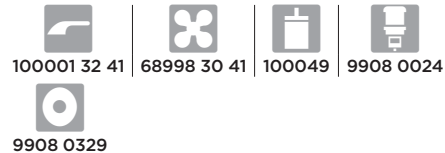

Ref.: 64116 32 41 66

Box: 1 | Carton: 12 | Pallet: 192

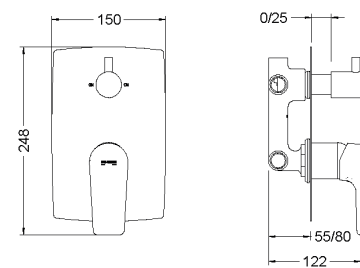

Ref.: 64118 32 41 66

Box: 1 | Carton: 9 | Pallet: 108

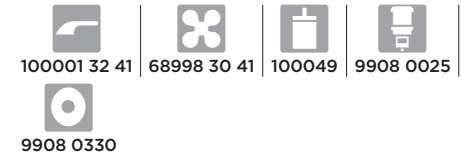

Ref.: CM64111 32 41

Box: 1 | Carton: 2 | Pallet: 18

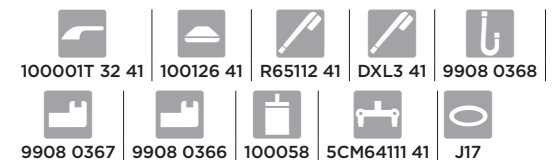

## Serie Kode Acabado cromado. Cartucho 40. Chromed finish. Cartridge 40

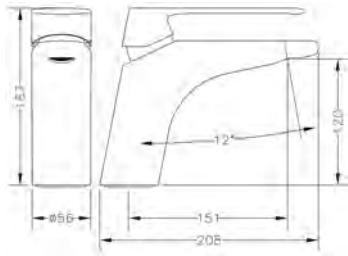

Ref.: 62130 08 45 66

Box: 1 | Carton: 8 | Pallet: 192



100001 08 45 | 100072 45 | 100045 | 100105 | 100092

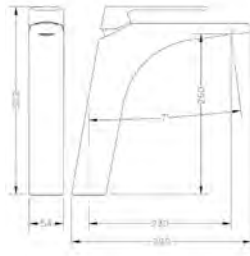

Ref.: 62136 08 45 66

Box: 1 | Carton: 4 | Pallet: 96



100001 08 45 | 100072 45 | 100064 | 100105



9908 0042



Ref.: 62131 31 45 66

Box: 1 | Carton: 6 | Pallet: 144



100001 31 45 | 68924 45 | 9908 0433 | 100049 | PO131

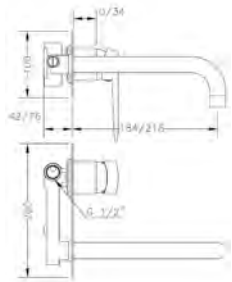

Ref.: 62132 31 45 66

Box: 1 | Carton: 6 | Pallet: 144



100001 31 45 | 68925 45 | 9908 0433 | 100049 | PO131

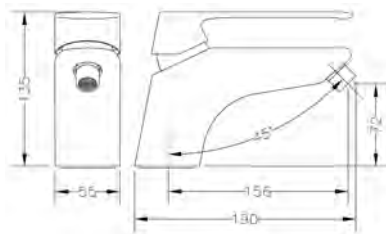

Ref.: 62140 08 45 66

Box: 1 | Carton: 8 | Pallet: 192



100001 08 45 | 100086 45 | 100045 | 100105



100092

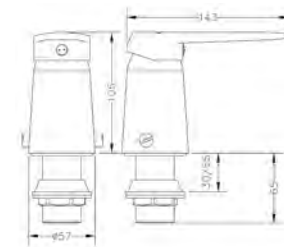

Ref.: 62142 31 45 66

Box: 1 | Carton: 12 | Pallet: 216



100001 31 45 | DB142 45 | 100051 | 100111 | 100104 | J15

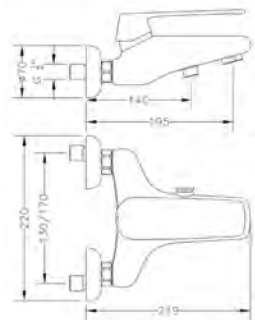

Ref.: 62100 08 45 67

Box: 1 | Carton: 6 | Pallet: 144



100001 08 45 | 100083 45 | 100045 | 100161 45



100114 45

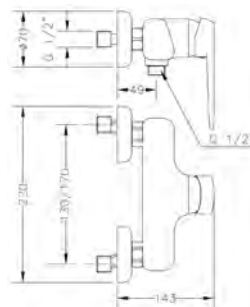

Ref.: 62110 31 45 67

Box: 1 | Carton: 6 | Pallet: 144



100001 31 45 | 100045 | 100114 45

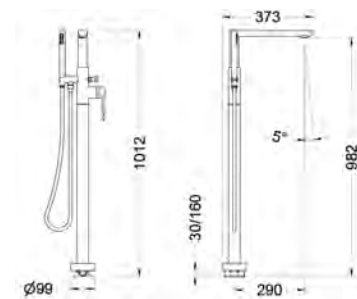

Ref.: 62119 31 45 66

Box: 1 | Carton: 2 | Pallet: 12



100001 31 45 | 9908 0246 | 100083 45 | 100051



9908 0247



**Serie Kode** Acabado cromado. Cartucho 40. Chromed finish. Cartridge 40

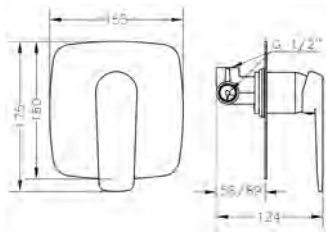

Ref.: 62115 31 45 66

Box: 1 | Carton: 8 | Pallet: 192

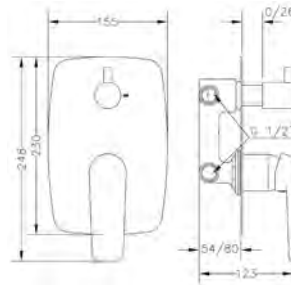

Ref.: 62117 31 45 66

Box: 1 | Carton: 6 | Pallet: 108

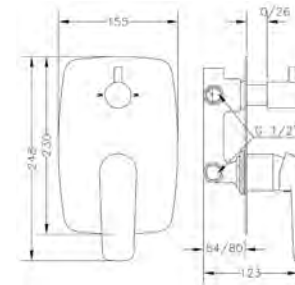
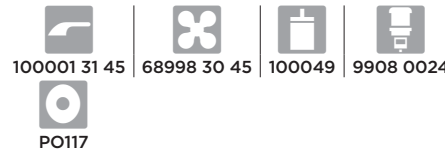

Ref.: 62118 31 45 66

Box: 1 | Carton: 6 | Pallet: 108

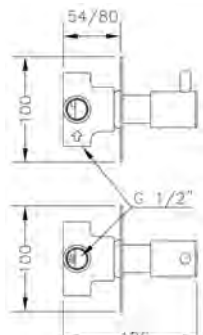
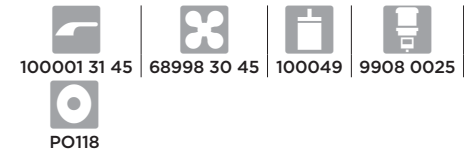

Ref.: 62114 30 45 66

Box: 1 | Carton: 8 | Pallet: 384



**Serie Oslo** Acabado cromado. Cartucho 35. Chromed finish. Cartridge 35

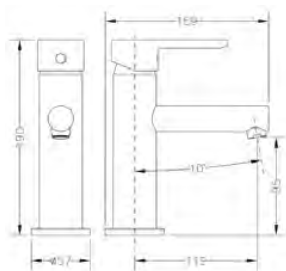

Ref.: 65150 19 45 66

Box: 1 | Carton: 12 | Pallet: 192



9908 0332

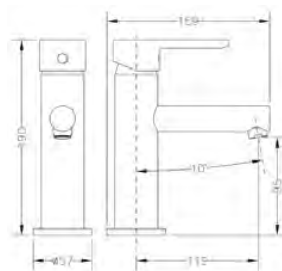

Ref.: 65130 19 45 66

Box: 1 | Carton: 12 | Pallet: 192

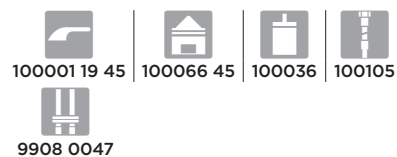

9908 0047

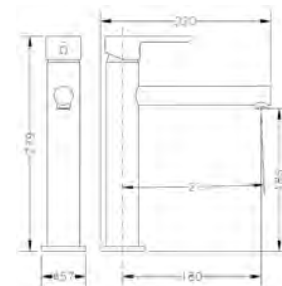

Ref.: 65134 19 45 66

Box: 1 | Carton: 10 | Pallet: 80



## Serie Oslo Acabado cromado. Cartucho 35. Chromed finish. Cartridge 35

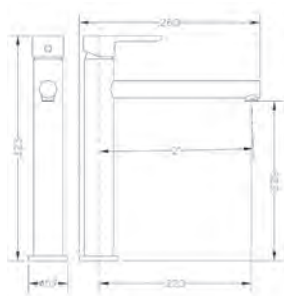

Ref.: 65136 19 45 66

Box: 1 | Carton: 10 | Pallet: 80

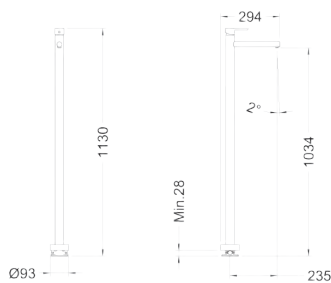
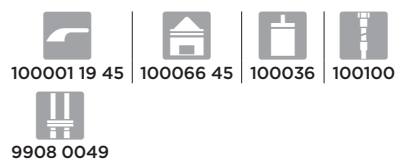

Ref.: 65139 19 45 66

Box: 1 | Carton: 2 | Pallet: 12

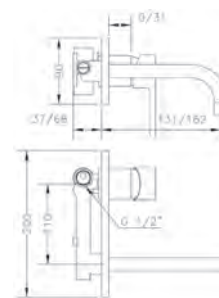

Ref.: 65131 19 45 66

Box: 1 | Carton: 6 | Pallet: 144

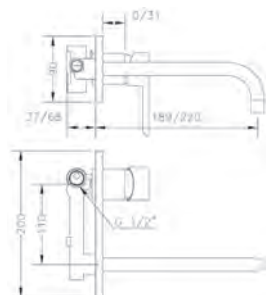

Ref.: 65132 19 45 66

Box: 1 | Carton: 6 | Pallet: 144

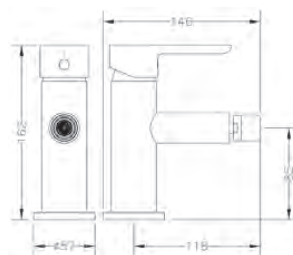

Ref.: 65140 19 45 66

Box: 1 | Carton: 12 | Pallet: 192

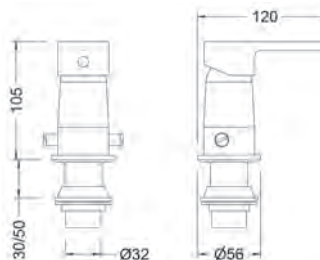
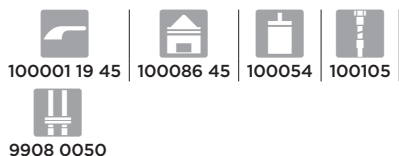

Ref.: 65142 19 45 66

Box: 1 | Carton: 12 | Pallet: 288

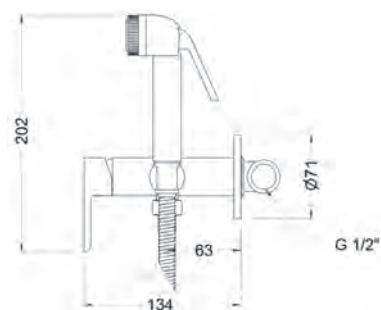

Ref.: 65144 19 45 66

Box: 1 | Carton: 18 | Pallet: 288

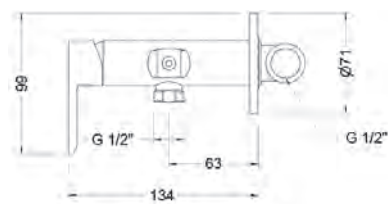

Ref.: 65144 19 45 67

Box: 1 | Carton: 20 | Pallet: 640

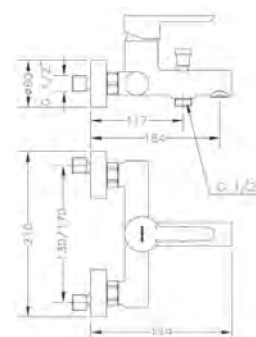

Ref.: 65100 19 45 66

Box: 1 | Carton: 8 | Pallet: 96

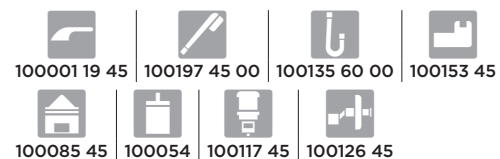





## Serie Oslo Acabado cromado. Cartucho 35. Chromed finish. Cartridge 35

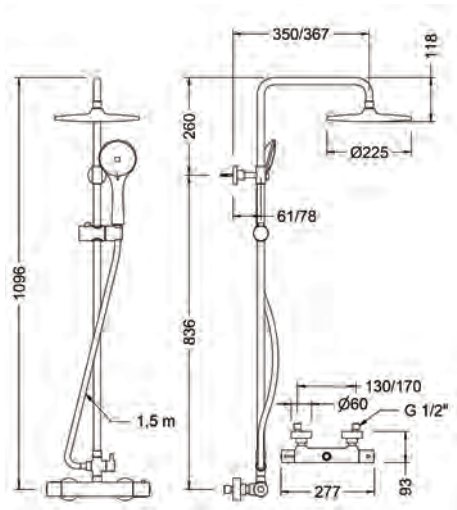

Ref.: CT67110 19

Box: 1 | Carton: 4 | Pallet: 24



## Serie Oslo Black

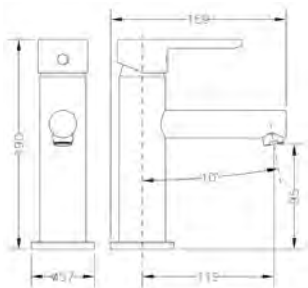

Ref.: 65130 19 41 66

Box: 1 | Carton: 12 | Pallet: 192

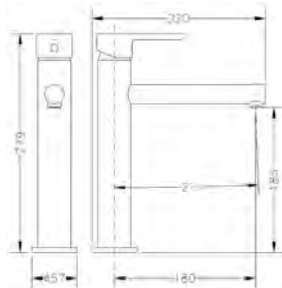
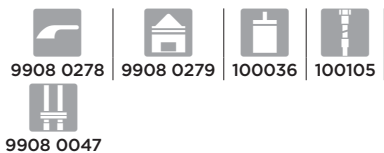

Ref.: 65134 19 41 66

Box: 1 | Carton: 10 | Pallet: 80

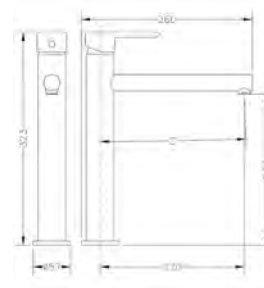
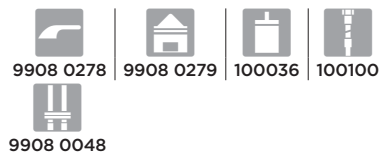

Ref.: 65136 19 41 66

Box: 1 | Carton: 10 | Pallet: 80



# Serie Oslo Black

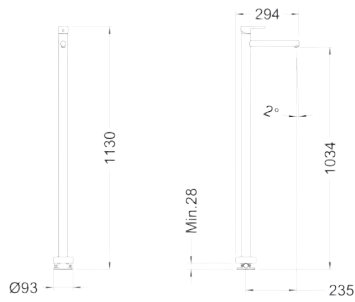

Ref.: 65139 19 41 66

Box: 1 | Carton: 2 | Pallet: 12

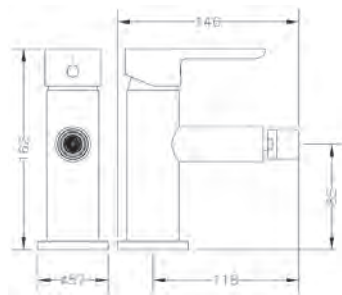

Ref.: 65140 19 41 66

Box: 1 | Carton: 12 | Pallet: 192



Ref.: 100694 41

Box: 1 | Carton: 22 | Pallet: 264

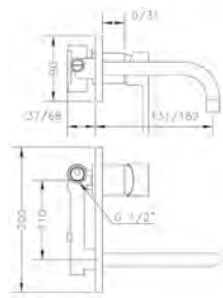

Ref.: 65131 19 41 66

Box: 1 | Carton: 6 | Pallet: 144

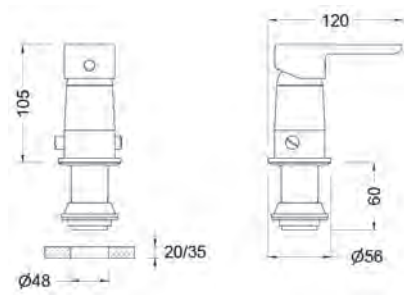

Ref.: 65142 19 41 66

Box: 1 | Carton: 12 | Pallet: 288

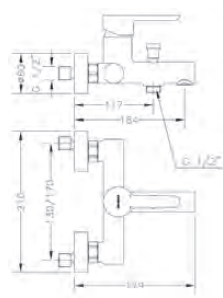

Ref.: 65100 19 41 66

Box: 1 | Carton: 8 | Pallet: 96

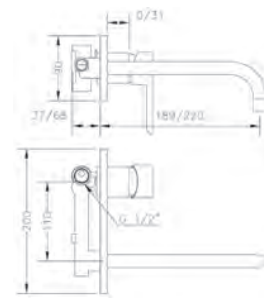

Ref.: 65132 19 41 66

Box: 1 | Carton: 6 | Pallet: 144

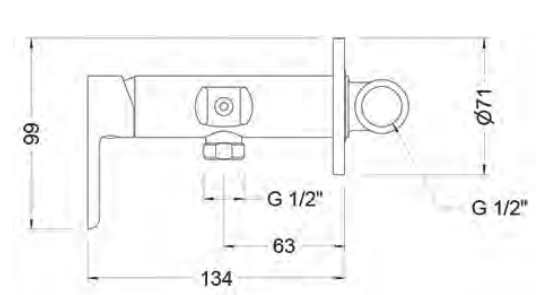

Ref.: 65144 19 41 67

Box: 1 | Carton: 20 | Pallet: 640

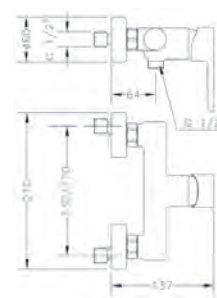

Ref.: 65110 19 41 66

Box: 1 | Carton: 8 | Pallet: 96



## Serie Oslo Black

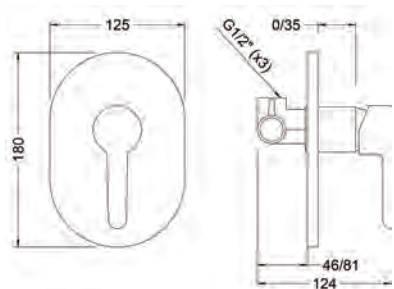

Ref.: 65115 19 41 66

Box: 1 | Carton: 12 | Pallet: 324

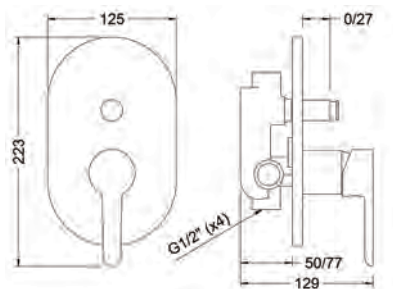

Ref.: 65116 19 41 66

Box: 1 | Carton: 12 | Pallet: 216

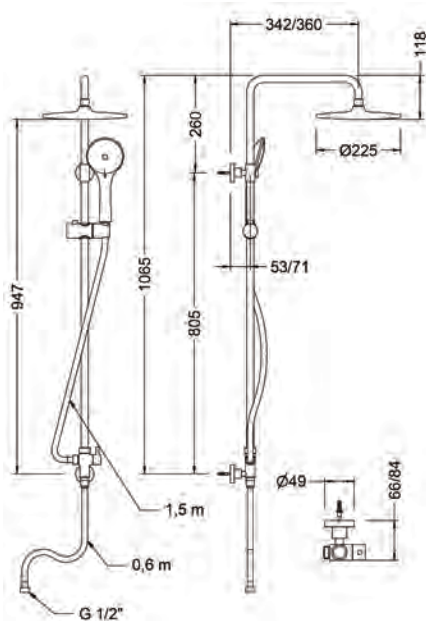

Ref.: 1744 41

Box: 1 | Carton: 4 | Pallet: 24

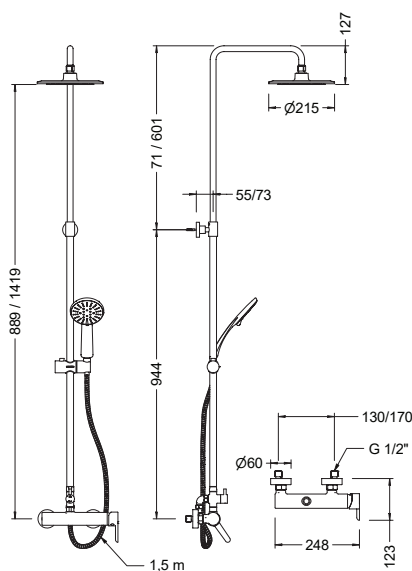
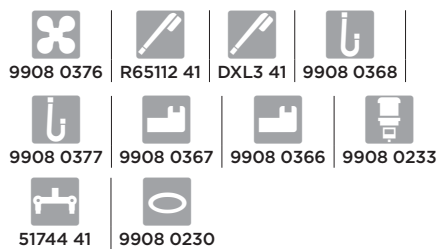

Ref.: CM65111 19 41

Box: 1 | Carton: 2 | Pallet: 12

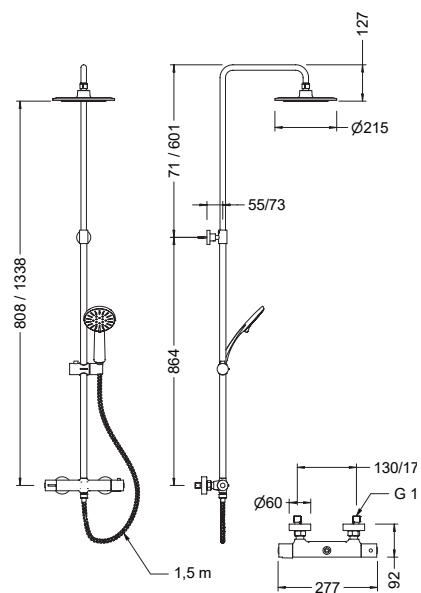
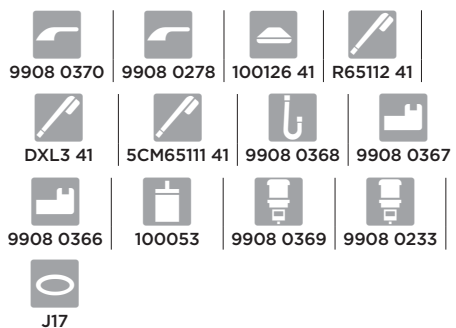

Ref.: CT67111 19 41

Box: 1 | Carton: 2 | Pallet: 12

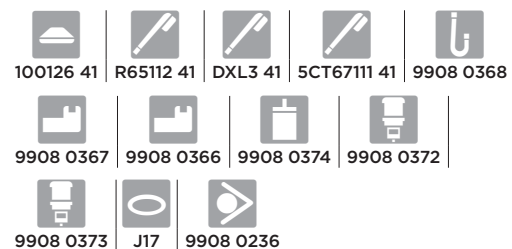



**Serie Klip** Acabado cromado. Cartucho 40. Chromed finish. Cartridge 40



Ref.: 64150 16 45 66

Box: 1 | Carton: 12 | Pallet: 288



Ref.: 64136 16 45 66

Box: 1 | Carton: 6 | Pallet: 108

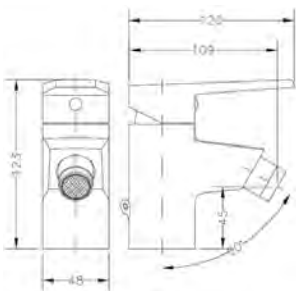

Ref.: 64140 16 45 66

Box: 1 | Carton: 8 | Pallet: 480



Ref.: 64130 16 45 66

Box: 1 | Carton: 12 | Pallet: 216

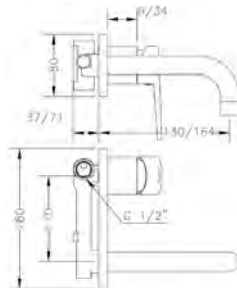

Ref.: 64131 16 45 66

Box: 1 | Carton: 6 | Pallet: 108

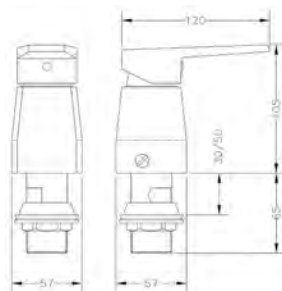

Ref.: 64142 16 45 66

Box: 1 | Carton: 12 | Pallet: 288

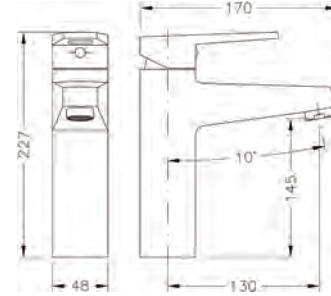

Ref.: 64134 16 45 66

Box: 1 | Carton: 10 | Pallet: 180

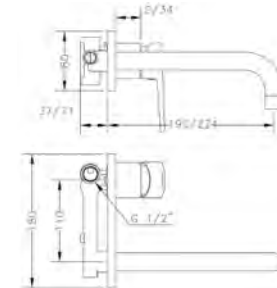

Ref.: 64132 16 45 66

Box: 1 | Carton: 6 | Pallet: 108

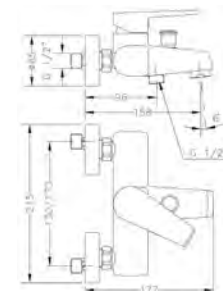
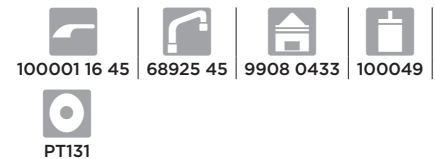

Ref.: 64100 16 45 66

Box: 1 | Carton: 8 | Pallet: 96



## Serie Klip Acabado cromado. Cartucho 40. Chromed finish. Cartridge 40

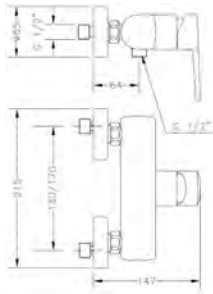

Ref.: 64110 16 45 66

Box: 1 | Carton: 8 | Pallet: 96

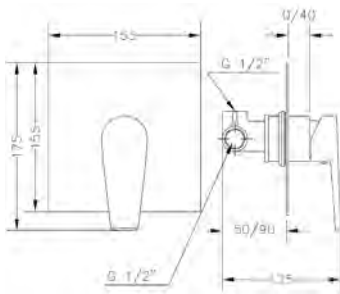

Ref.: 64115 16 45 66

Box: 1 | Carton: 12 | Pallet: 216

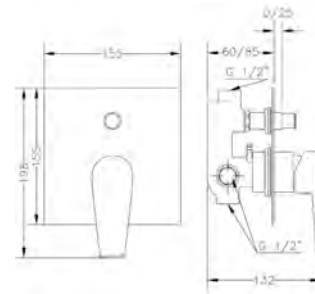

Ref.: 64116 16 45 66

Box: 1 | Carton: 12 | Pallet: 216

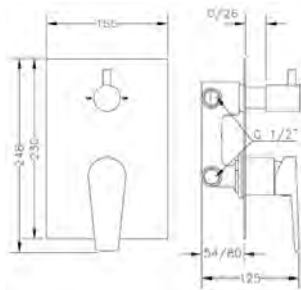

Ref.: 64117 04 45 66

Box: 1 | Carton: 6 | Pallet: 108

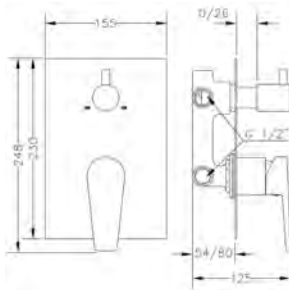
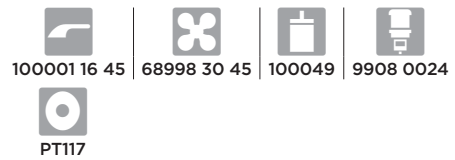

Ref.: 64118 04 45 66

Box: 1 | Carton: 6 | Pallet: 108

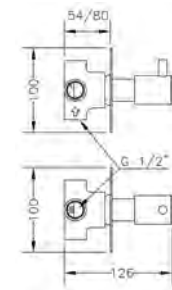
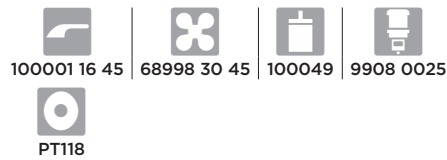

Ref.: 65114 30 45 66

Box: 1 | Carton: 8 | Pallet: 288



Ref.: 67103 14 45 67

Box: 1 | Carton: 6 | Pallet: 108

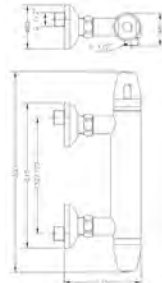
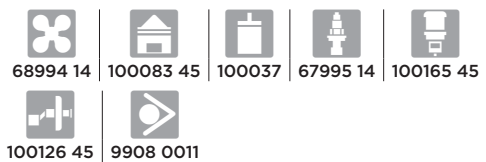

Ref.: 67104 14 45 67

Box: 1 | Carton: 11 | Pallet: 264



**Serie Tau** Acabado cromado. Cartucho 40. Chromed finish. Cartridge 40

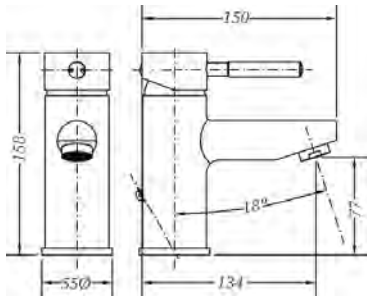

Ref.: 65135 18 45 66

Box: 1 | Carton: 12 | Pallet: 216

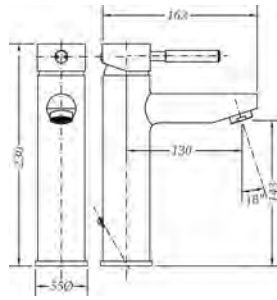

Ref.: 65134 18 45 66

Box: 1 | Carton: 10 | Pallet: 240

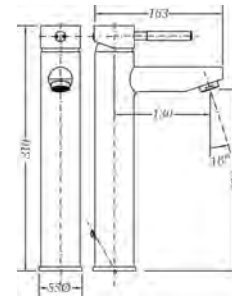

Ref.: 65136 18 45 66

Box: 1 | Carton: 6 | Pallet: 108

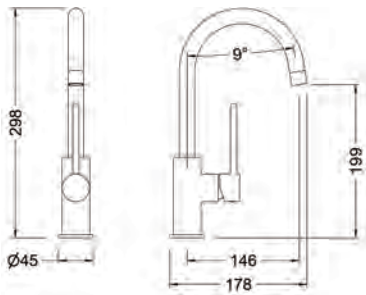

Ref.: 65138 18 45 66

Box: 1 | Carton: 10 | Pallet: 120

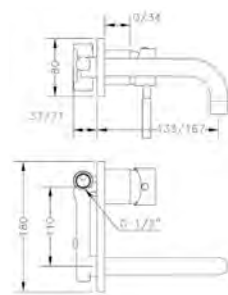
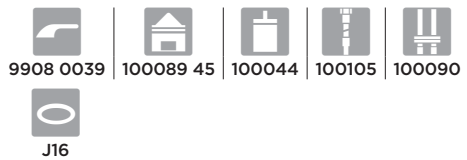

Ref.: 65131 18 45 66

Box: 1 | Carton: 6 | Pallet: 108

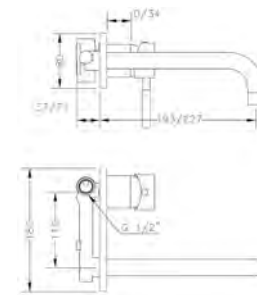
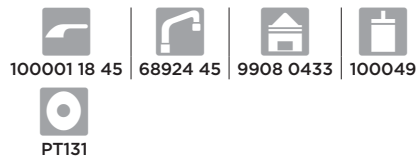

Ref.: 65132 18 45 66

Box: 1 | Carton: 6 | Pallet: 144

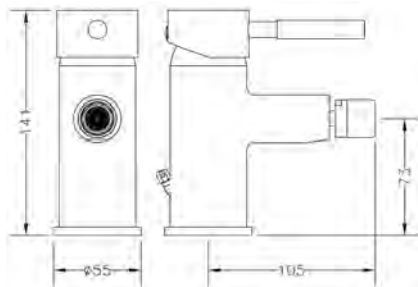

Ref.: 65145 18 45 66

Box: 1 | Carton: 8 | Pallet: 384

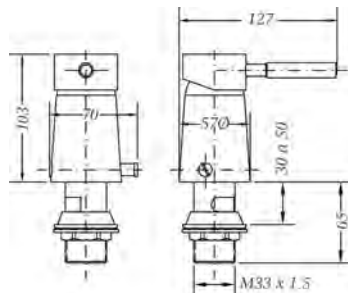

Ref.: 65142 18 45 66

Box: 1 | Carton: 12 | Pallet: 288

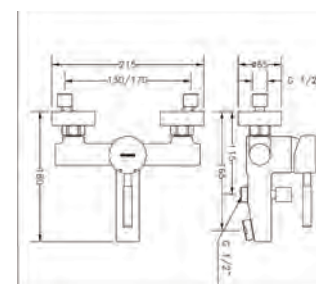

Ref.: 65100 18 45 66

Box: 1 | Carton: 6 | Pallet: 108

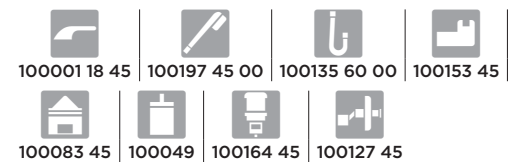



# Serie Tau Acabado cromado. Cartucho 40. Chromed finish. Cartridge 40

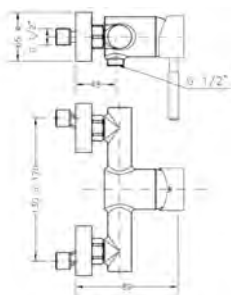

Ref.: 65110 18 45 66

Box: 1 | Carton: 6 | Pallet: 108

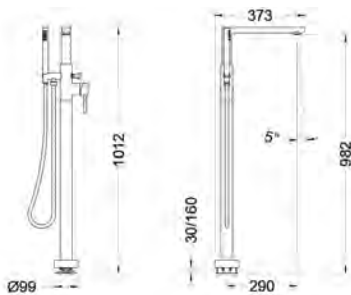

Ref.: 65119 18 45 66

Box: 1 | Carton: 2 | Pallet: 12

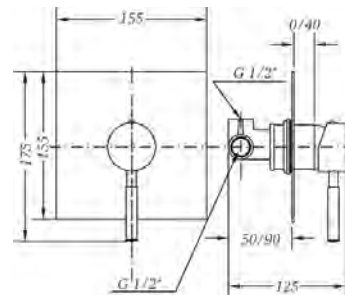

Ref.: 65115 18 45 66

Box: 1 | Carton: 12 | Pallet: 216

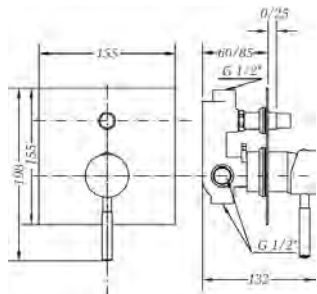

Ref.: 65116 18 45 66

Box: 1 | Carton: 12 | Pallet: 216

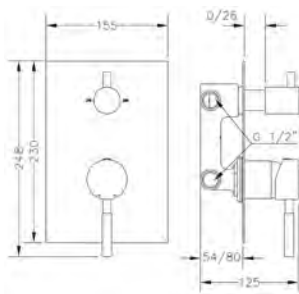

Ref.: 65117 18 45 66

Box: 1 | Carton: 6 | Pallet: 108

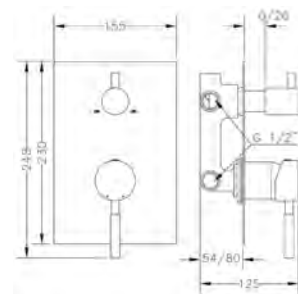
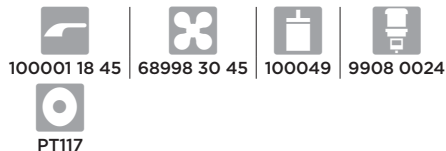

Ref.: 65118 18 45 66

Box: 1 | Carton: 6 | Pallet: 108

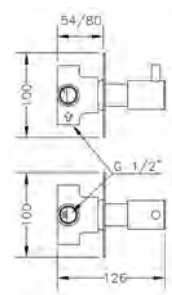
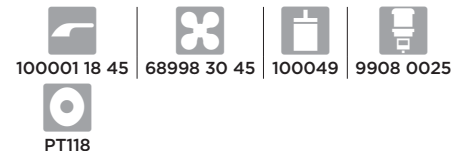

Ref.: 65114 30 45 66

Box: 1 | Carton: 8 | Pallet: 288

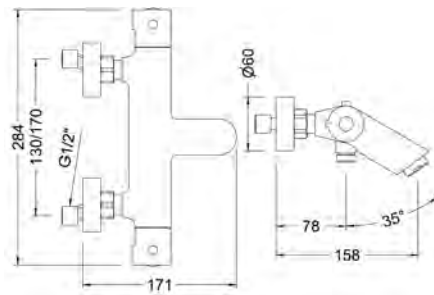

Ref.: 67102 14 45 67

Box: 1 | Carton: 6 | Pallet: 144

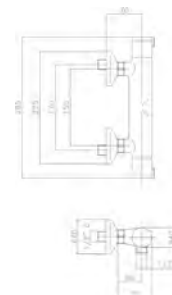

Ref.: 67112 14 45 67

Box: 1 | Carton: 12 | Pallet: 288



**Serie Tau** Acabado cromado. Cartucho 40. Chromed finish. Cartridge 40

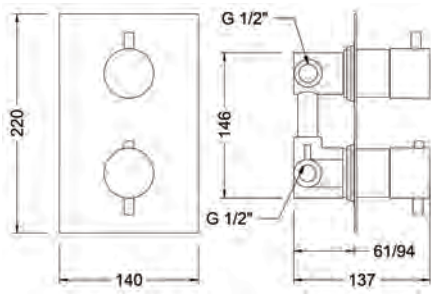

Ref.: 64114 14 45 67

Box: 1 | Carton: 4 | Pallet: 72

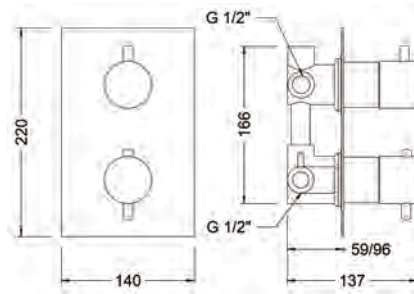
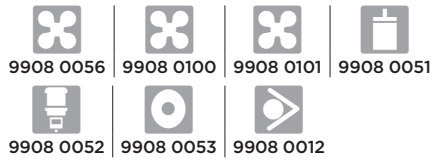

Ref.: 64111 14 45 67

Box: 1 | Carton: 4 | Pallet: 72

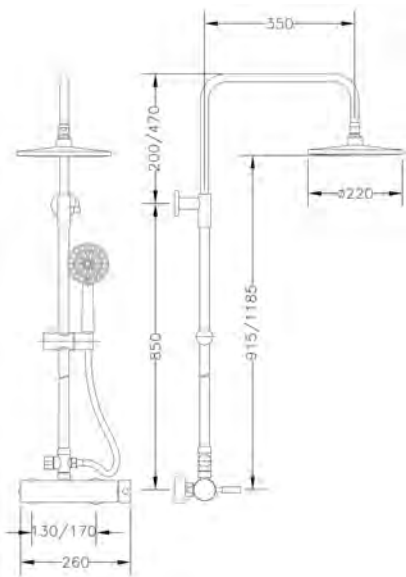

Ref.: CM65110 18

Box: 1 | Carton: 2 | Pallet: 24

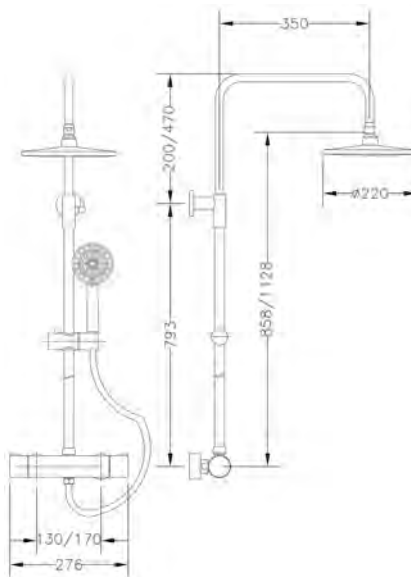
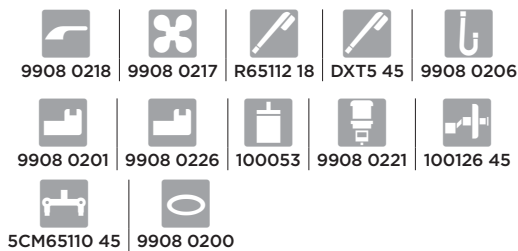

Ref.: CT67110 18

Box: 1 | Carton: 2 | Pallet: 24

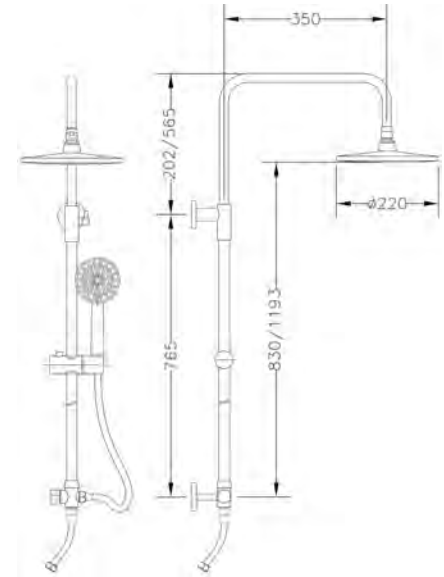

Ref.: 1745 45

Box: 1 | Carton: 2 | Pallet: 24

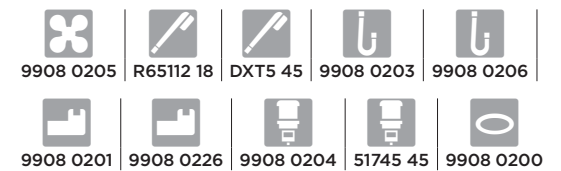

## Serie Tau2 Acabado cromado. Cartucho 40. Chromed finish. Cartridge 40

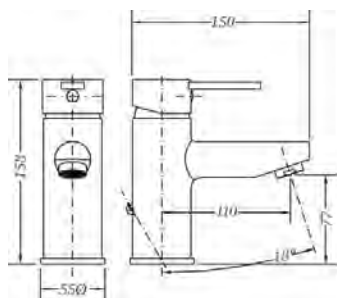

Ref.: 65135 29 45 66

Box: 1 | Carton: 12 | Pallet: 216



100001 29 45 | 100085 45 | 100051 | 100105 | 100091

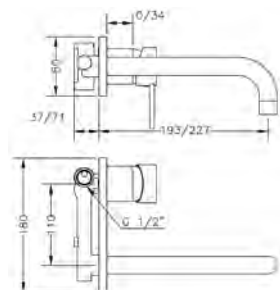

Ref.: 65132 29 45 66

Box: 1 | Carton: 6 | Pallet: 144



100001 29 45 | 68925 45 | 9908 0433 | 100049 | PT131



Ref.: 65100 29 45 66

Box: 1 | Carton: 6 | Pallet: 108

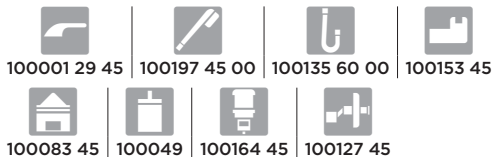

100001 29 45 | 100197 45 00 | 100135 60 00 | 100153 45  
100083 45 | 100049 | 100164 45 | 100127 45

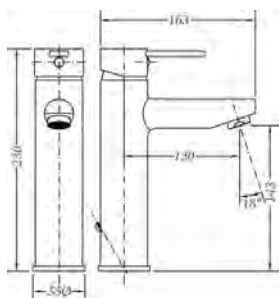

Ref.: 65134 29 45 66

Box: 1 | Carton: 10 | Pallet: 180



100001 29 45 | 100085 45 | 100049 | 100103 | 100091

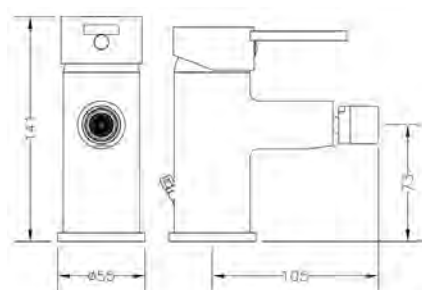

Ref.: 65145 29 45 66

Box: 1 | Carton: 8 | Pallet: 384



100001 29 45 | 100086 45 | 100051 | 100105 | 100091

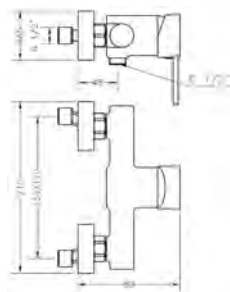

Ref.: 65110 29 45 66

Box: 1 | Carton: 6 | Pallet: 108



100001 29 45 | 100197 45 00 | 100135 60 00  
100153 45 | 100049 | 100127 45

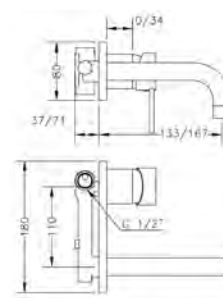

Ref.: 65131 29 45 66

Box: 1 | Carton: 6 | Pallet: 144



100001 29 45 | 68924 45 | 9908 0433 | 100049



PT131

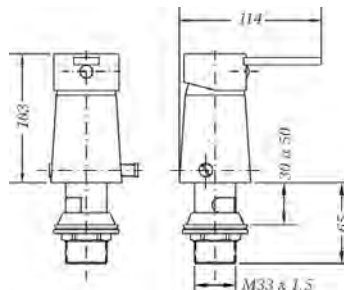

Ref.: 65142 29 45 66

Box: 1 | Carton: 12 | Pallet: 288



100001 29 45 | DB142 45 | 100051 | 100111 | 100104



J15

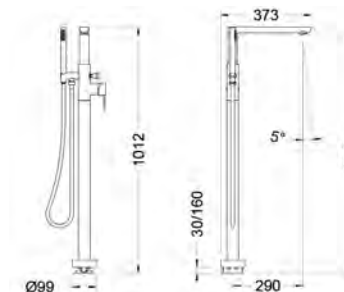

Ref.: 65119 29 45 66

Box: 1 | Carton: 2 | Pallet: 8

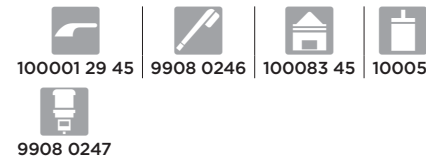

100001 29 45 | 9908 0246 | 100083 45 | 100051  
9908 0247



**Serie Tau2** Acabado cromado. Cartucho 40. Chromed finish. Cartridge 40

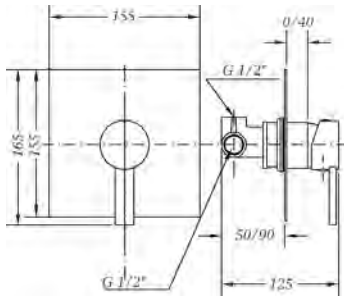

Ref.: 65115 29 45 66

Box: 1 | Carton: 12 | Pallet: 216

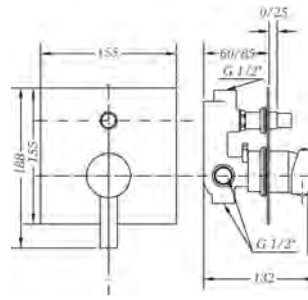

Ref.: 65116 29 45 66

Box: 1 | Carton: 12 | Pallet: 216

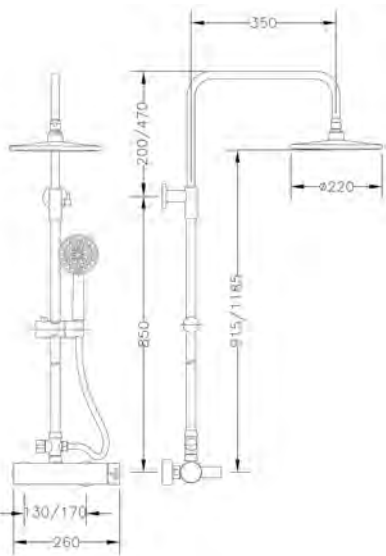

Ref.: CM65110 29

Box: 1 | Carton: 2 | Pallet: 24

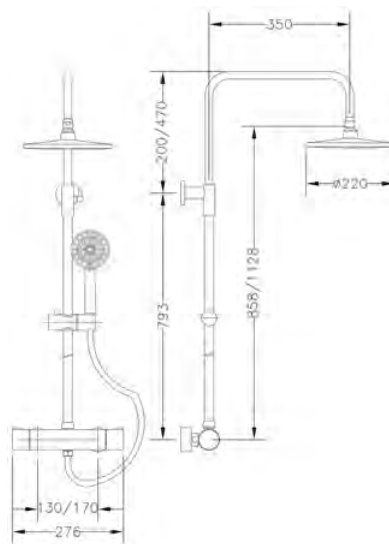
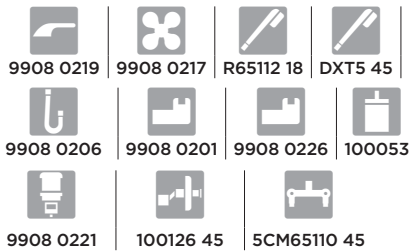

Ref.: CT67110 18

Box: 1 | Carton: 2 | Pallet: 24

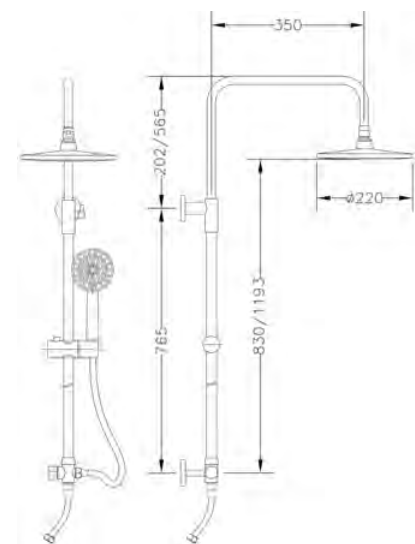
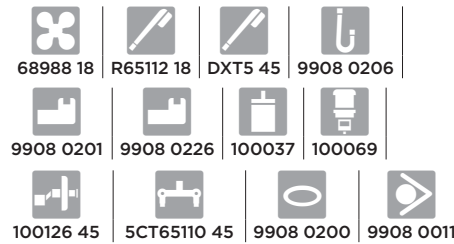

Ref.: 1745 45

Box: 1 | Carton: 2 | Pallet: 24

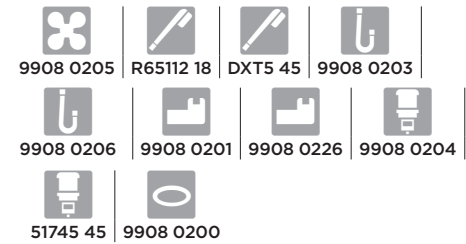

## Serie Kenjo Acabado cromado. Cartucho 35. Chromed finish. Cartridge 35

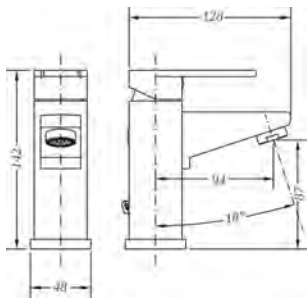

Ref.: 63130 26 45 66  
Box: 1 | Carton: 20 | Pallet: 360

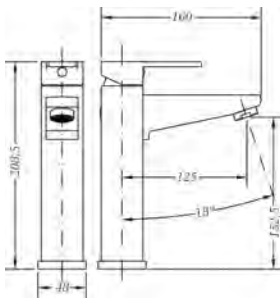

Ref.: 63134 26 45 66  
Box: 1 | Carton: 8 | Pallet: 192

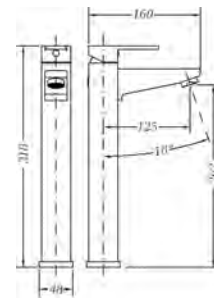

Ref.: 63136 26 45 66  
Box: 1 | Carton: 6 | Pallet: 108

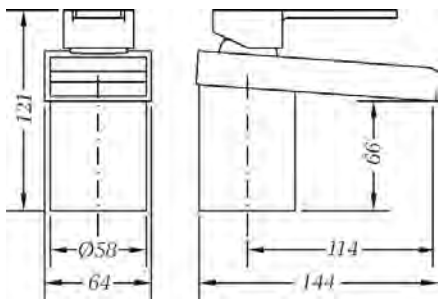

Ref.: 63137 26 45 66  
Box: 1 | Carton: 20 | Pallet: 360

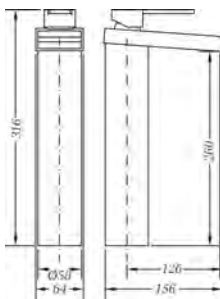

Ref.: 63138 26 45 66  
Box: 1 | Carton: 6 | Pallet: 108

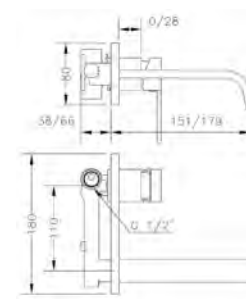

Ref.: 63131 26 45 66  
Box: 1 | Carton: 6 | Pallet: 108

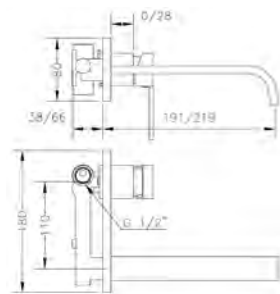

Ref.: 63132 26 45 66  
Box: 1 | Carton: 6 | Pallet: 108

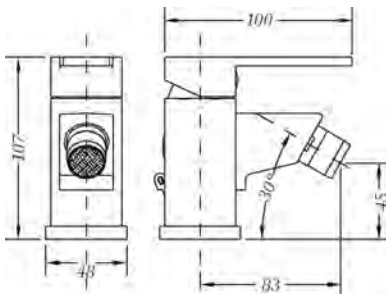

Ref.: 63140 26 45 66  
Box: 1 | Carton: 8 | Pallet: 384

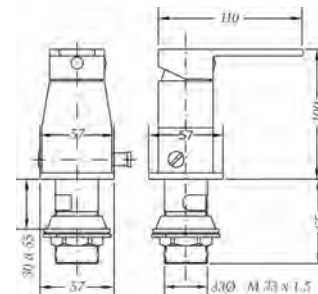

Ref.: 63142 26 45 66  
Box: 1 | Carton: 12 | Pallet: 216



**Serie Kenjo** Acabado cromado. Cartucho 35. Chromed finish. Cartridge 35

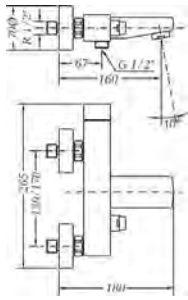

**Ref.:** 63100 26 45 67  
**Box: 1 | Carton: 6 | Pallet: 162**

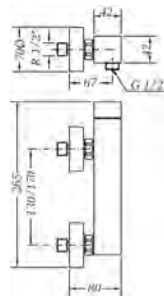
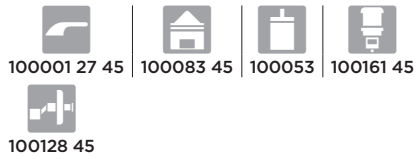

**Ref.:** 63110 26 45 67  
**Box: 1 | Carton: 10 | Pallet: 180**

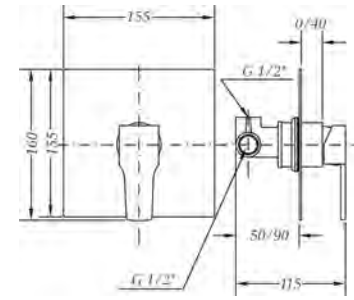

**Ref.:** 63115 26 45 66  
**Box: 1 | Carton: 12 | Pallet: 216**

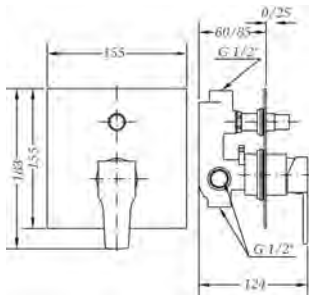

**Ref.:** 63116 26 45 66  
**Box: 1 | Carton: 12 | Pallet: 216**

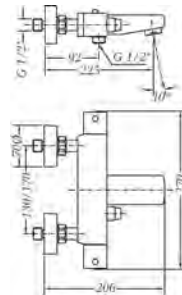

**Ref.:** 67100 26 45 67  
**Box: 1 | Carton: 6 | Pallet: 144**

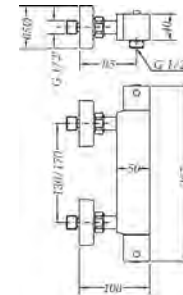
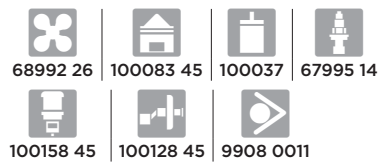

**Ref.:** 67110 26 45 67  
**Box: 1 | Carton: 9 | Pallet: 216**

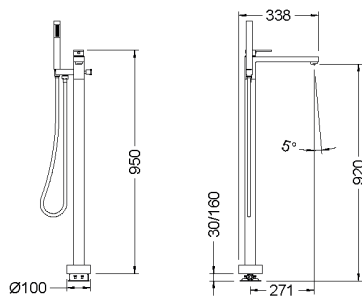

**Ref.:** 63119 26 45 66  
**Box: 1 | Carton: 2 | Pallet: 12**





## Serie Kenjo Acabado cromado. Cartucho 35. Chromed finish. Cartridge 35

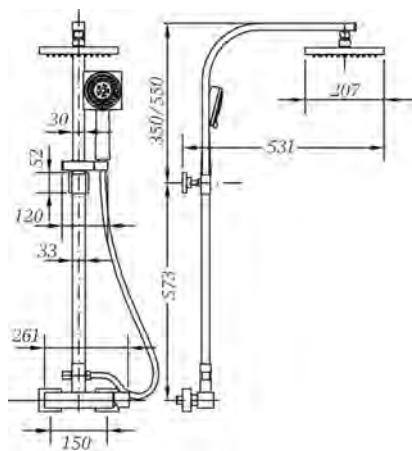

Ref.: CM63110 26

Box: 1 | Carton: 2 | Pallet: 24

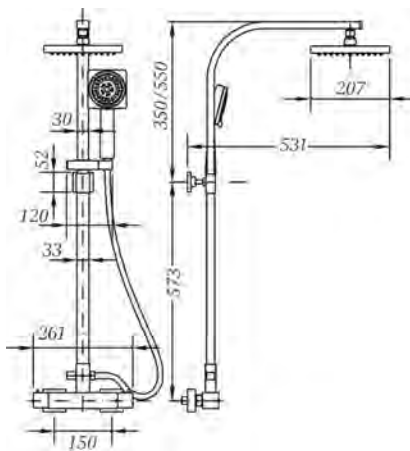

Ref.: CT67110 26

Box: 1 | Carton: 2 | Pallet: 24

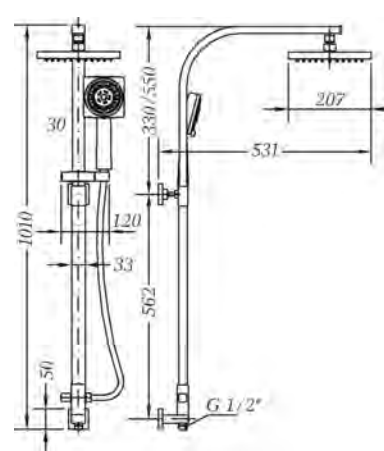

Ref.: 1746 45

Box: 1 | Carton: 2 | Pallet: 24

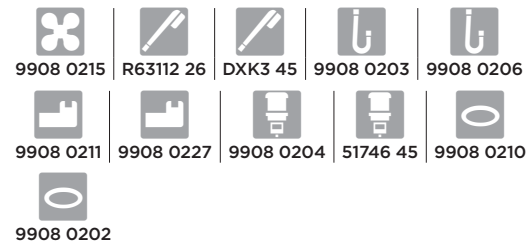

## Serie K8 Acabado cromado. Cartucho 40. Chromed finish. Cartridge 40

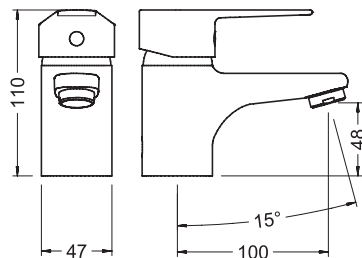

Ref.: 60150 28 45 66

Box: 1 | Carton: 21 | Pallet: 420

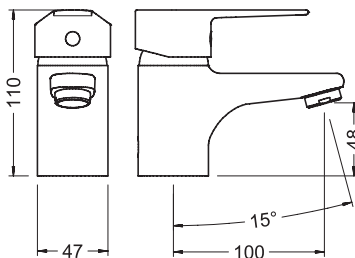
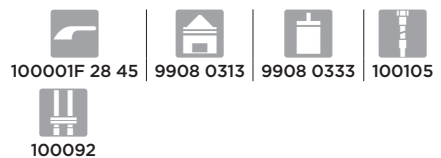

Ref.: 60130 28 45 66

Box: 1 | Carton: 21 | Pallet: 420

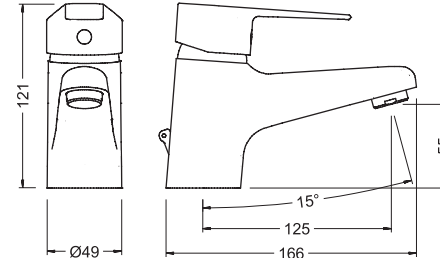
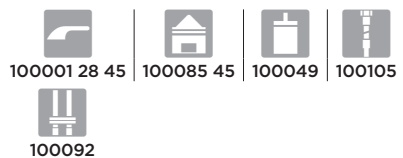

Ref.: 61150 28 45 66

Box: 1 | Carton: 21 | Pallet: 336

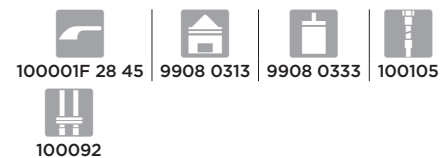

**Serie K8** Acabado cromado. Cartucho 40. Chromed finish. Cartridge 40

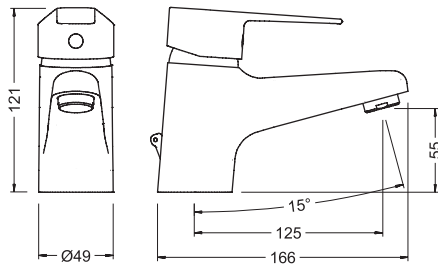

Ref.: 61130 28 45 66

Box: 1 | Carton: 21 | Pallet: 336

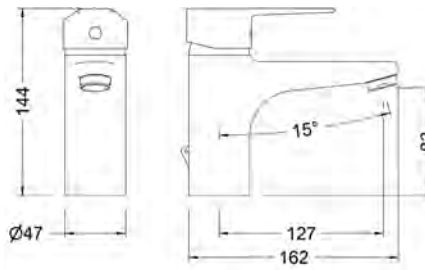

Ref.: 60154 28 45 66

Box: 1 | Carton: 6 | Pallet: 240

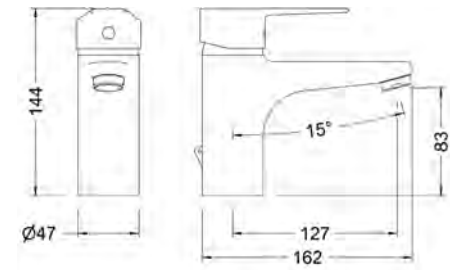
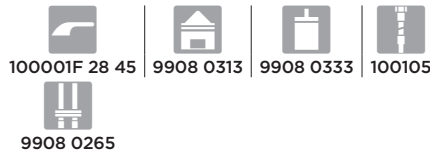

Ref.: 60134 28 45 66

Box: 1 | Carton: 6 | Pallet: 240

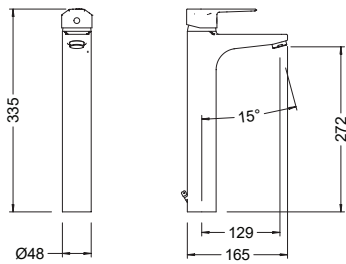
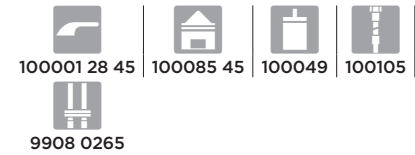

Ref.: 60136 28 45 66

Box: 1 | Carton: 10 | Pallet: 120

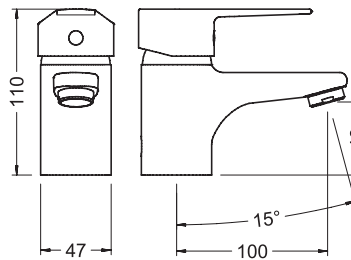

Ref.: 60130 28 45 66

Box: 1 | Carton: 21 | Pallet: 420

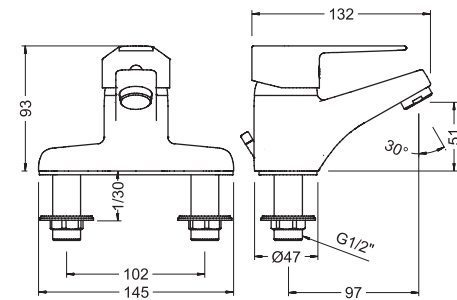

Ref.: 60188 28 45 66

Box: 1 | Carton: 12 | Pallet: 216

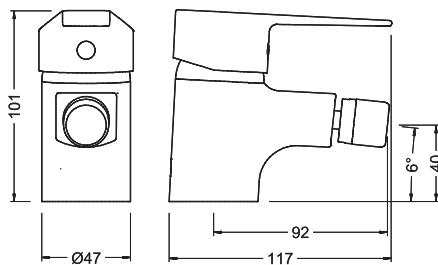

Ref.: 60140 28 45 66

Box: 1 | Carton: 8 | Pallet: 480

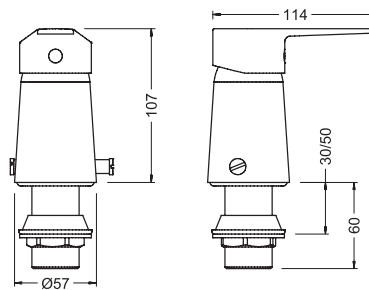

Ref.: 61142 28 45 66

Box: 1 | Carton: 12 | Pallet: 288

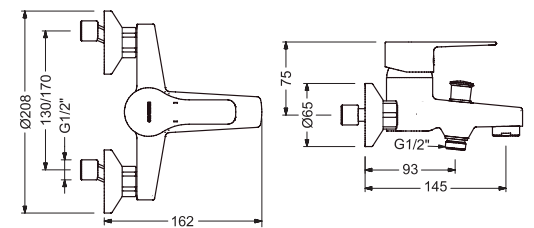

Ref.: 60100 28 45 66

Box: 1 | Carton: 8 | Pallet: 128



## Serie K8 Acabado cromado. Cartucho 40. Chromed finish. Cartridge 40

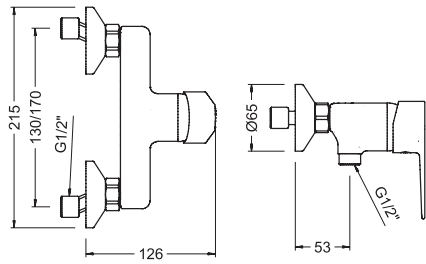

Ref.: 60110 28 45 66

Box: 1 | Carton: 10 | Pallet: 160

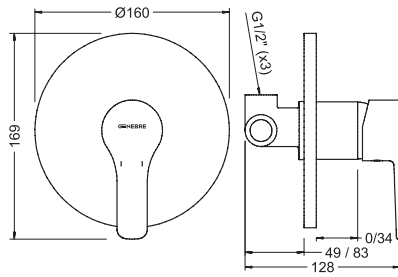
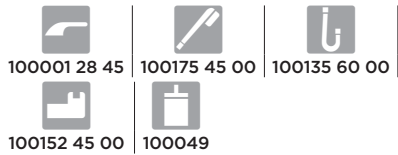

Ref.: 61115 28 45 66

Box: 1 | Carton: 12 | Pallet: 216

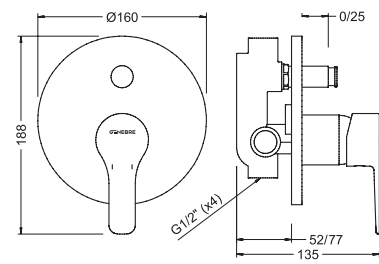

Ref.: 61116 28 45 66

Box: 1 | Carton: 12 | Pallet: 216



## Serie Ge2 Acabado cromado. Cartucho 40. Chromed finish. Cartridge 40

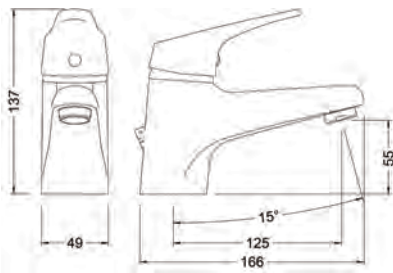

Ref.: 61130 22 45 66

Box: 1 | Carton: 8 | Pallet: 320

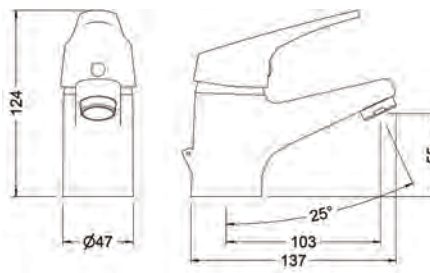

Ref.: 60130 22 45 66

Box: 1 | Carton: 20 | Pallet: 540

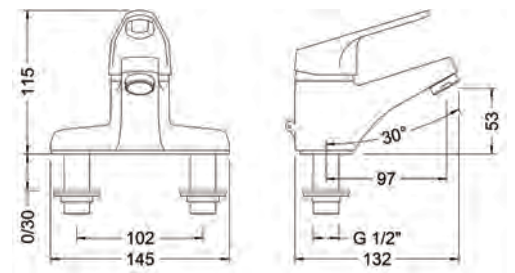

Ref.: 60188 22 45 66

Box: 1 | Carton: 12 | Pallet: 216

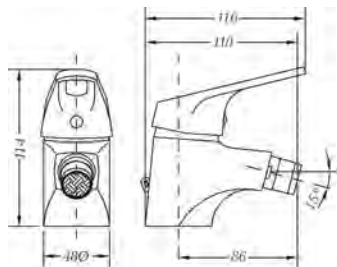

Ref.: 60140 22 45 66

Box: 1 | Carton: 8 | Pallet: 480

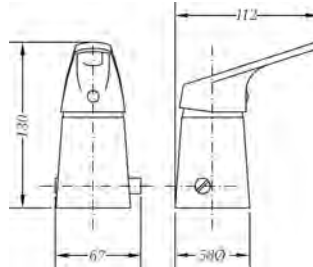

Ref.: 61142 22 45 66

Box: 1 | Carton: 12 | Pallet: 288







## Serie Ge2 Acabado cromado. Cartucho 40. Chromed finish. Cartridge 40

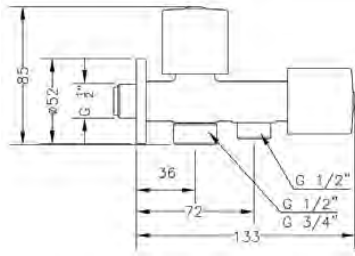

Ref.: 1023 04

Box: 1 | Carton: 48 | Pallet: 864



68998 28 45 | 68995 09

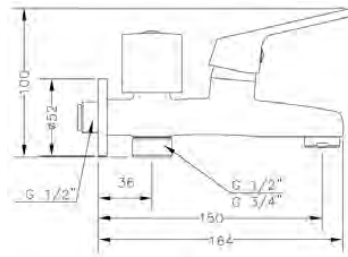

Ref.: 1024 04

Box: 1 | Carton: 22 | Pallet: 704



100001 33 45 | 68998 28 45 | 100085 45 | 100042



68995 09

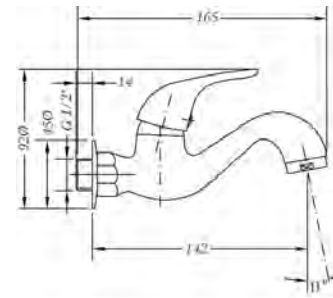

Ref.: 1006 04

Box: 1 | Carton: 36 | Pallet: 864



100085 45 | 100042



Ref.: 1007 04

Box: 1 | Carton: 22 | Pallet: 704



100085 45 | 100042 | 100098

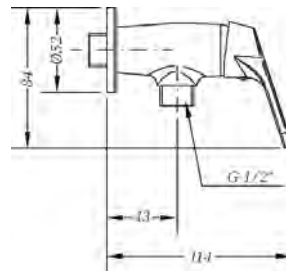

Ref.: 60001 22 45 67

Box: 1 | Carton: 54 | Pallet: 972



100001 33 45 | 100042

## Serie New Regent Classic Montura 1/4 vuelta cierre cerámico. Ceramic headwork quarter turn

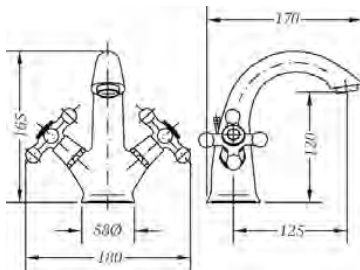

Ref.: 68506 09 45 66

Box: 1 | Carton: 8 | Pallet: 144



68998 09 45 | 100085 45 | 68995 09 | 100103 | 100090

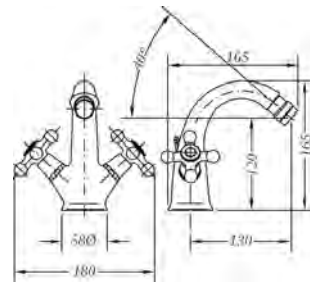

Ref.: 68516 09 45 66

Box: 1 | Carton: 8 | Pallet: 144



68998 09 45 | 100086 45 | 68995 09 | 100103 | 100090

# Serie New Regent Classic Montura 1/4 vuelta cierre cerámico. Ceramic headwork quarter turn

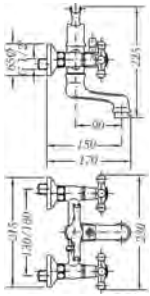

Ref.: 68526 09 45 66

Box: 1 | Carton: 4 | Pallet: 72

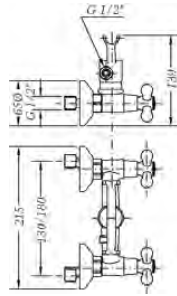
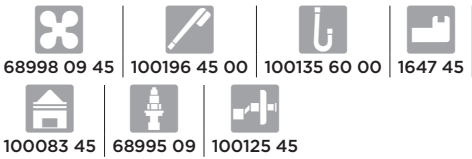

Ref.: 68531 09 45 66

Box: 1 | Carton: 8 | Pallet: 96

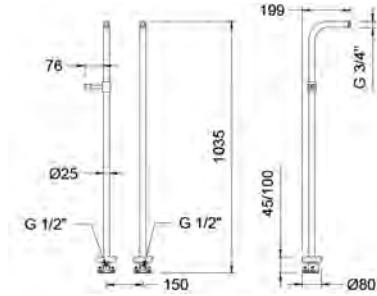
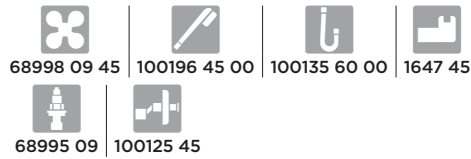

Ref.: 65120 45

Box: 1 | Carton: 2 | Pallet: 24

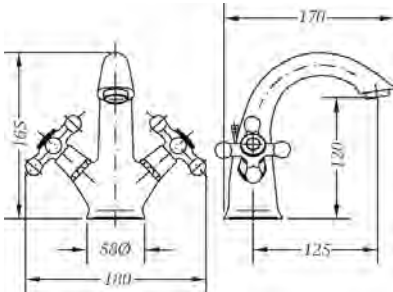

Ref.: 68506 09 43 66

Box: 1 | Carton: 8 | Pallet: 144

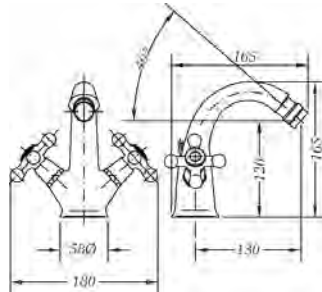

Ref.: 68516 09 43 66

Box: 1 | Carton: 8 | Pallet: 144

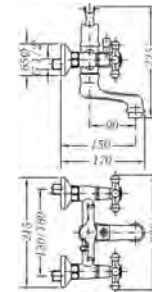
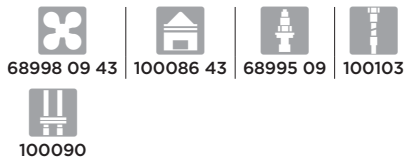

Ref.: 68526 09 43 66

Box: 1 | Carton: 4 | Pallet: 72

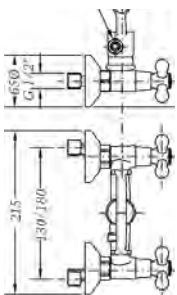
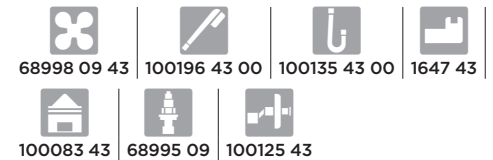

Ref.: 68531 09 43 66

Box: 1 | Carton: 8 | Pallet: 96

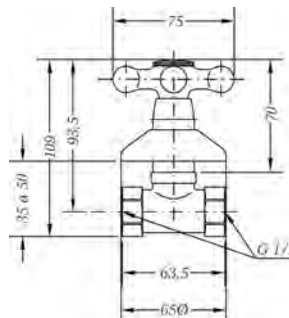

Ref.: 68590 09 43 66

Box: 1 | Carton: 24 | Pallet: 576







**Serie New Regent Classic** Acabado cromado. Montura 1/4 vuelta cierre cerámico. Chromed finish. Ceramic headwork quarter turn

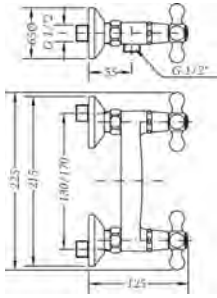

Ref.: 68530 09 45 66

Box: 1 | Carton: 12 | Pallet: 216

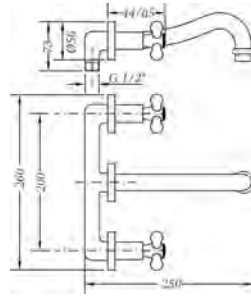
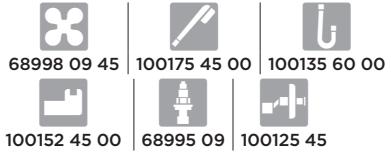

Ref.: 68131 09 45 66

Box: 1 | Carton: 10 | Pallet: 240

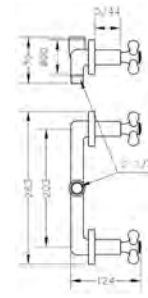
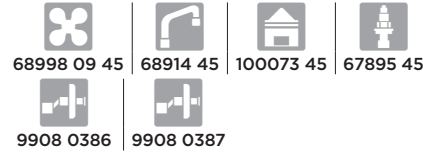

Ref.: 68535 09 45 66

Box: 1 | Carton: 10 | Pallet: 240

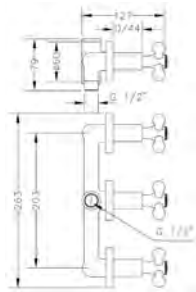

Ref.: 68527 09 45 66

Box: 1 | Carton: 10

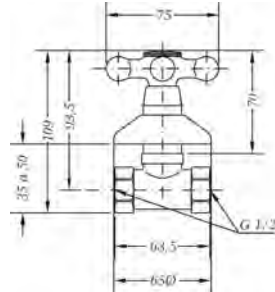
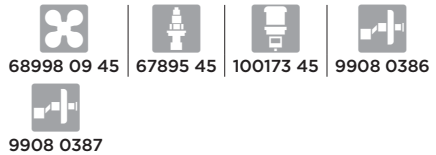

Ref.: 68590 09 45 66

Box: 1 | Carton: 24 | Pallet: 576

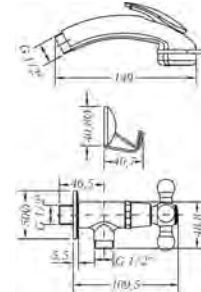

Ref.: 68001 09 45 66

Box: 1 | Carton: 20 | Pallet: 360







**Serie Gamma** Acabado cromado. Montura convencional. Chromed finish. Conventional headwork

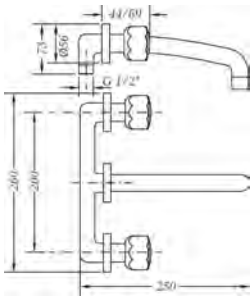

Ref.: 68131 11 45 66

Box: 1 | Carton: 10 | Pallet: 240

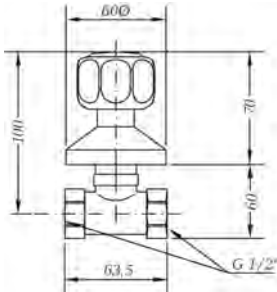

Ref.: 68170 11 45 66

Box: 1 | Carton: 24 | Pallet: 576

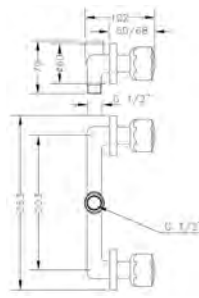
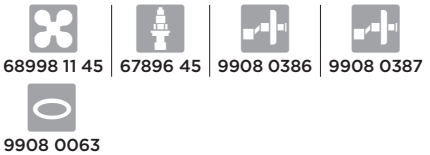

Ref.: 68115 11 45 66

Box: 1 | Carton: 10 | Pallet: 240

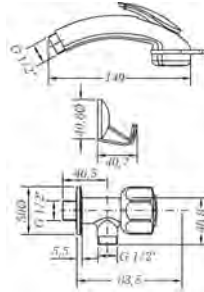

Ref.: 68001 11 45 66

Box: 1 | Carton: 20 | Pallet: 360

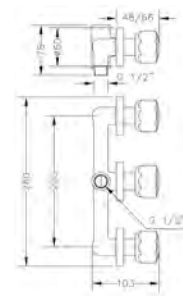

Ref.: 68116 11 45 66

Box: 1 | Carton: 10 | Pallet: 240



**Serie Kalo** Acabado cromado. Montura 1/4 vuelta cierre cerámico. Chromed finish. Ceramic headwork quarter turn

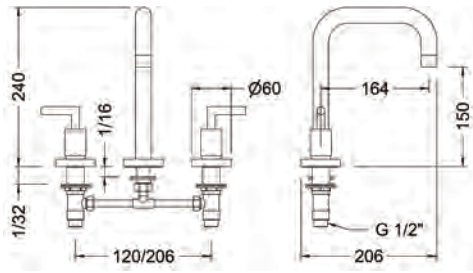

Ref.: 68120 07 45 66

Carton: 1

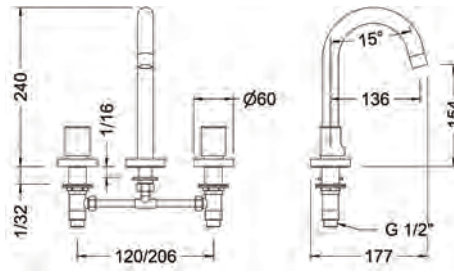
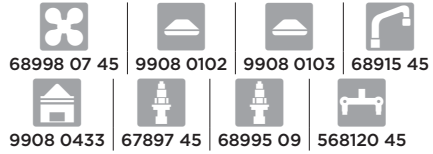

Ref.: 68124 07 45 66

Carton: 1

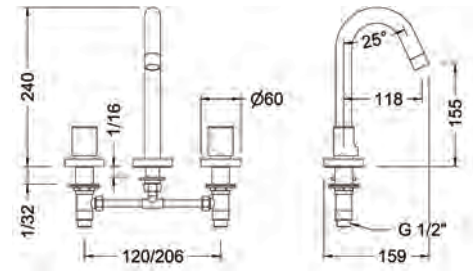
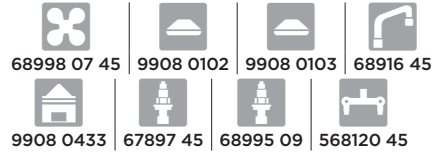

Ref.: 68125 07 45 66

Carton: 1

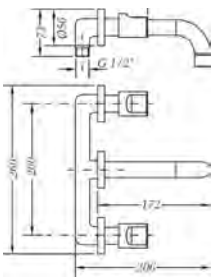
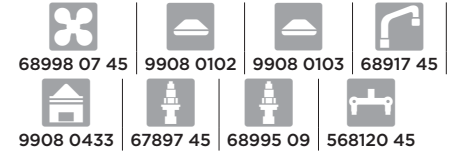

Ref.: 68131 07 45 66

Carton: 1

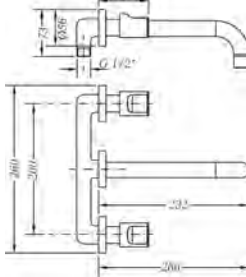

Ref.: 68132 07 45 66

Carton: 1

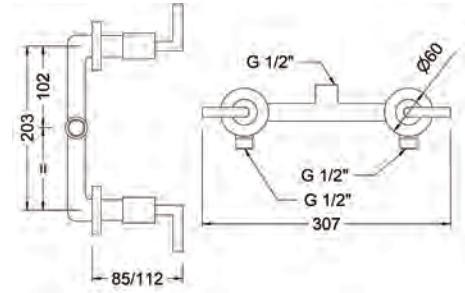

Ref.: 68115 07 45 66

Carton: 1

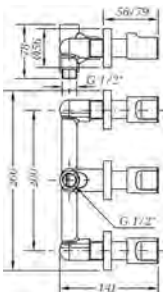
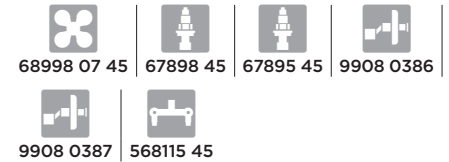

Ref.: 68116 07 45 66

Carton: 1

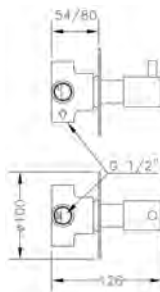
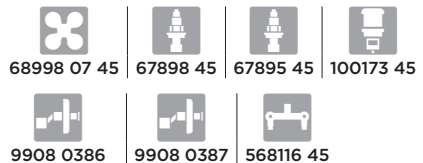

Ref.: 63114 30 45 66

Box: 1 | Carton: 8 | Pallet: 384

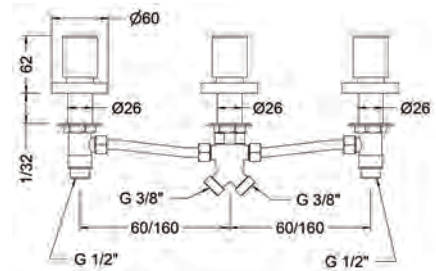

Ref.: 68113 07 45 66

Carton: 1



**Serie Kalo** Acabado cromado. Montura 1/4 vuelta cierre cerámico. Chromed finish. Ceramic headwork quarter turn

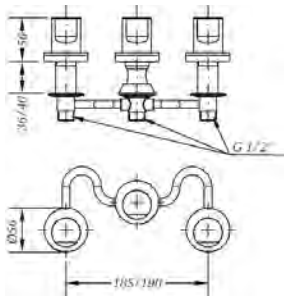

Ref.: 68142 07 45 66

Carton: 1

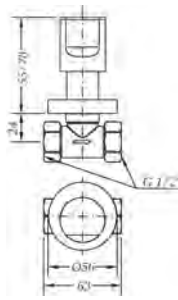
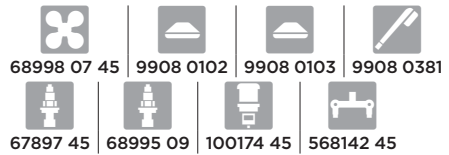

Ref.: 68170 07 45 66

Carton: 1

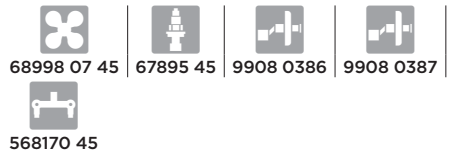

Las series Kalo, Kross e Ixo nacen de la combinación de diferentes componentes: cuerpos, caños y volantes. Busque la combinación que mejor se adapte a su baño. Puede pedirla utilizando la referencia del catálogo (conjunto) o bien por referencia de cada uno de los componentes. En este apartado podrá identificar fácilmente las referencias de cada componente necesario.

The series Kalo, Kross and Ixo are born from the combination of different components: bodies, pipes and handles. Look for the combination that best suits your bathroom. You can order it using the set reference or by components reference. In this section you can easily identify the references of each required component

**Serie Kross** Acabado cromado. Montura 1/4 vuelta cierre cerámico. Chromed finish. Ceramic headwork quarter turn

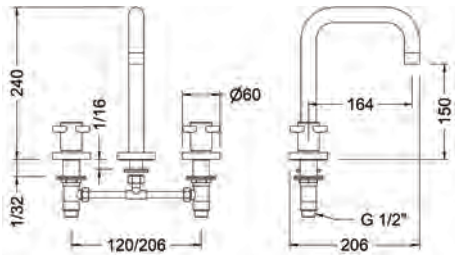

Ref.: 68120 08 45 66

Carton: 1

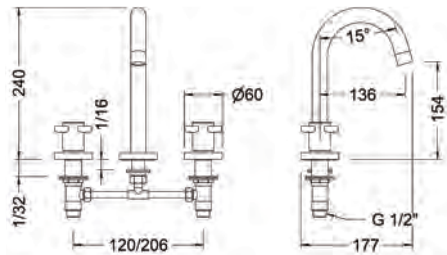

Ref.: 68124 08 45 66

Carton: 1

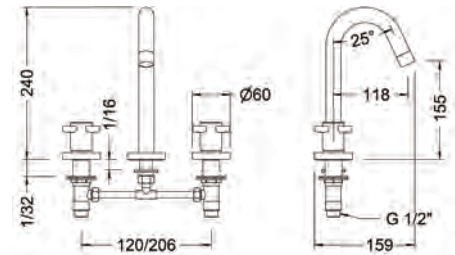
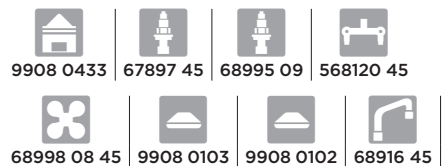

Ref.: 68125 08 45 66

Carton: 1

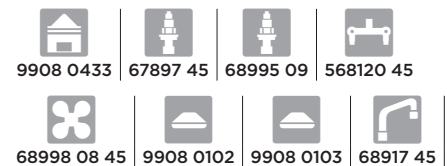



## Serie Kross Acabado cromado. Montura 1/4 vuelta cierre cerámico. Chromed finish. Ceramic headwork quarter turn

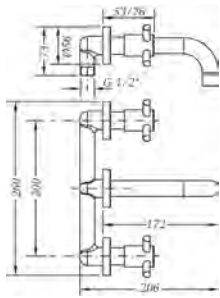

Ref.: 68131 08 45 66

Carton: 1

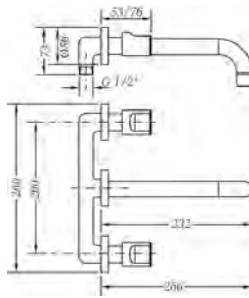

Ref.: 68132 08 45 66

Carton: 1

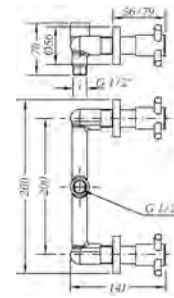

Ref.: 68115 08 45 66

Carton: 1

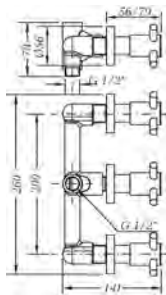
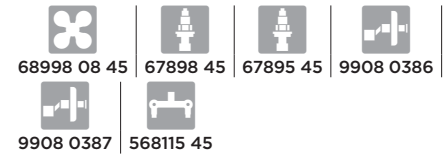

Ref.: 68116 08 45 66

Carton: 1

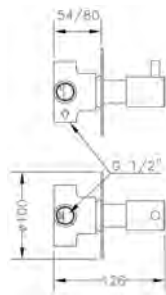
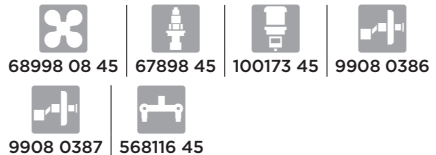

Ref.: 63114 30 45 66

Box: 1 | Carton: 8 | Pallet: 384

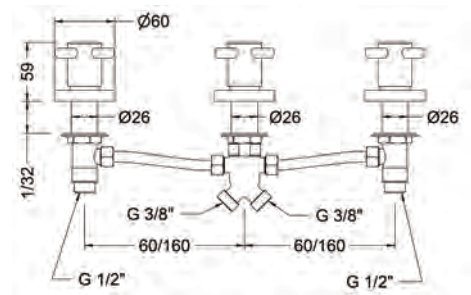

Ref.: 68113 08 45 66

Carton: 1

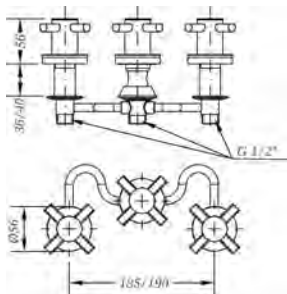

Ref.: 68142 08 45 66

Carton: 1

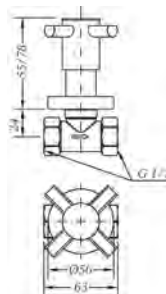
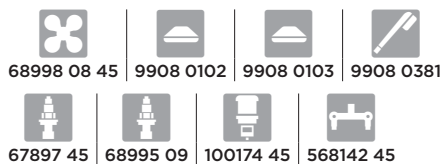

Ref.: 68170 08 45 66

Carton: 1

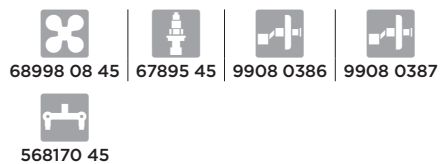

Las series Kalo, Kross e Ixo nacen de la combinación de diferentes componentes: cuerpos, caños y volantes. Busque la combinación que mejor se adapte a su baño. Puede pedirla utilizando la referencia del catálogo (conjunto) o bien por referencia de cada uno de los componentes. En este apartado podrá identificar fácilmente las referencias de cada componente necesario.

The series Kalo, Kross and Ixo are born from the combination of different components: bodies, pipes and handles. Look for the combination that best suits your bathroom. You can order it using the set reference or by components reference. In this section you can easily identify the references of each required component

**Serie Ixo** Acabado cromado. Montura 1/4 vuelta cierre cerámico. Chromed finish. Ceramic headwork quarter turn

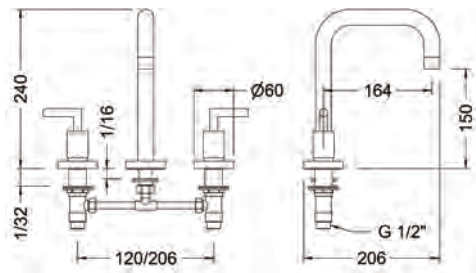

Ref.: 68120 12 45 66

Carton: 1

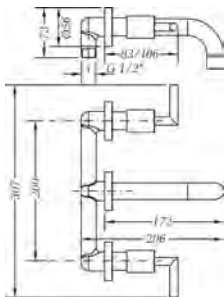
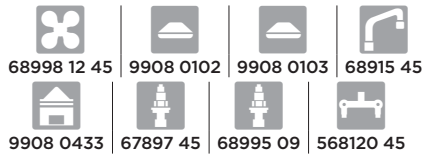

Ref.: 68131 12 45 66

Carton: 1

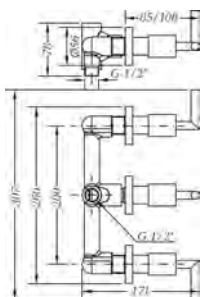

Ref.: 68116 12 45 66

Carton: 1

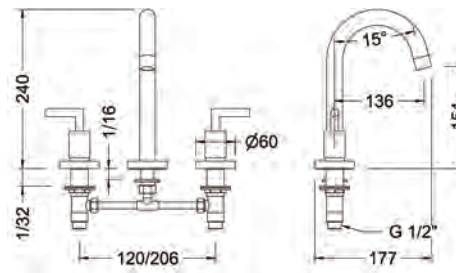
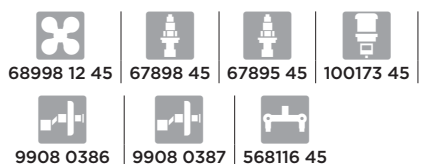

Ref.: 68124 12 45 66

Carton: 1

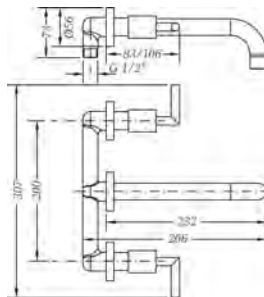
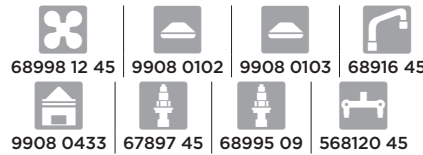

Ref.: 68132 12 45 66

Carton: 1



Ref.: 63114 30 45 66

Box: 1 | Carton: 8 | Pallet: 384

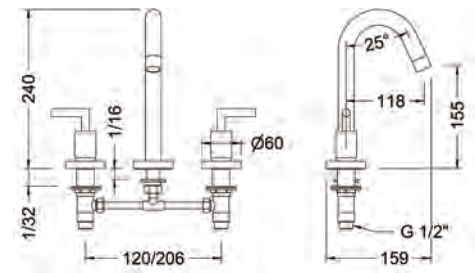

Ref.: 68125 12 45 66

Carton: 1

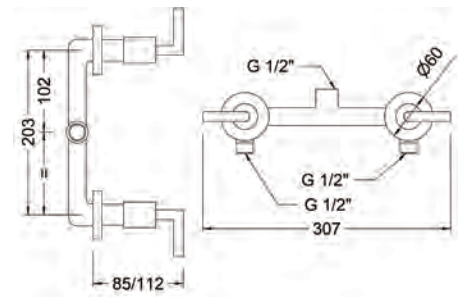
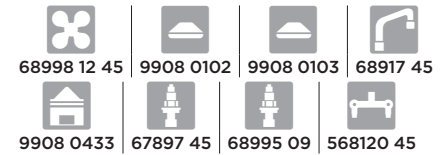

Ref.: 68115 12 45 66

Carton: 1

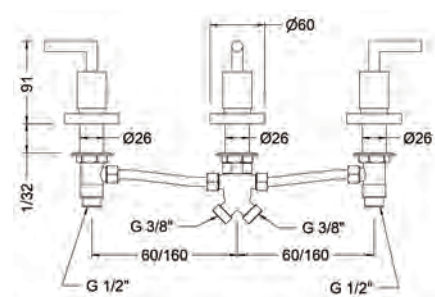
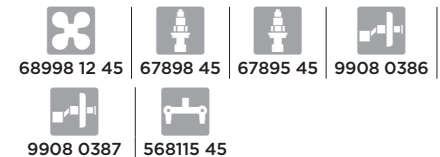

Ref.: 68113 12 45 66

Carton: 1



## Serie Ixo Acabado cromado. Montura 1/4 vuelta cierre cerámico. Chromed finish. Ceramic headwork quarter turn

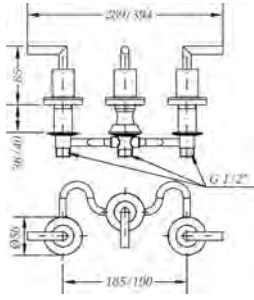

Ref.: 68142 12 45 66

Carton: 1

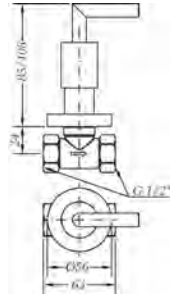

Ref.: 68170 12 45 66

Carton: 1

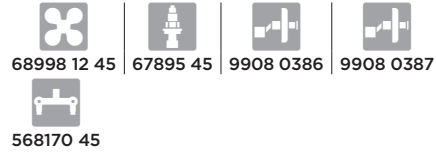

Las series Kalo, Kross e Ixo nacen de la combinación de diferentes componentes: cuerpos, caños y volantes. Busque la combinación que mejor se adapte a su baño. Puede pedirla utilizando la referencia del catálogo (conjunto) o bien por referencia de cada uno de los componentes. En este apartado podrá identificar fácilmente las referencias de cada componente necesario.

The series Kalo, Kross and Ixo are born from the combination of different components: bodies, pipes and handles. Look for the combination that best suits your bathroom. You can order it using the set reference or by components reference. In this section you can easily identify the references of each required component

## Cocinas. Kitchen

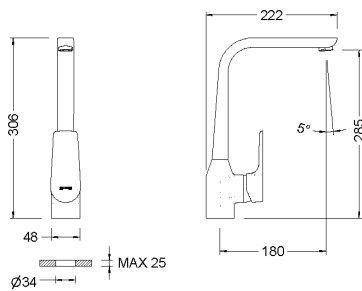

Ref.: 64201 32 45 66

Box: 1 | Carton: 8 | Pallet: 144

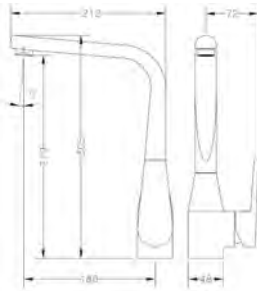
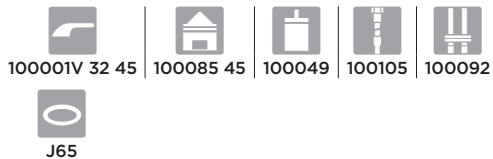

Ref.: 64201 16 45 66

Box: 1 | Carton: 8 | Pallet: 96

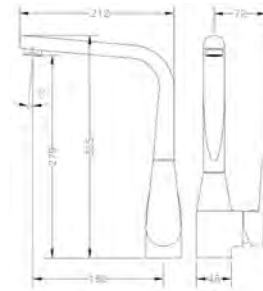
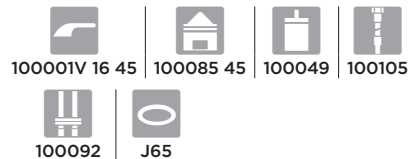

Ref.: 64201 04 45 66

Box: 1 | Carton: 8 | Pallet: 144

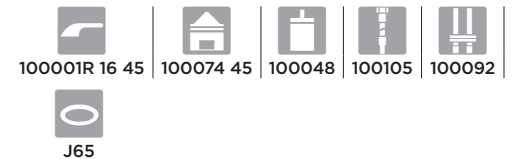



# Cocinas. Kitchen

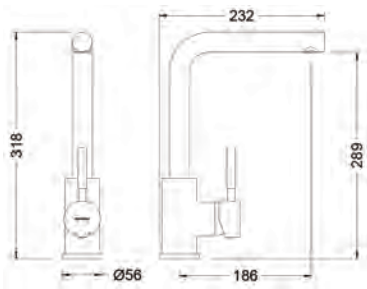

Ref.: 65214 18 45 66

Box: 1 | Carton: 5 | Pallet: 135

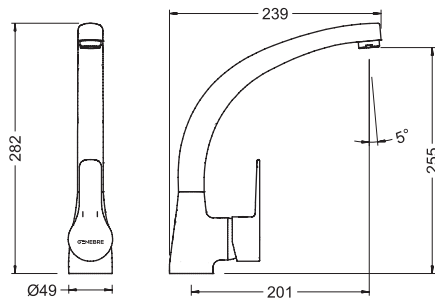
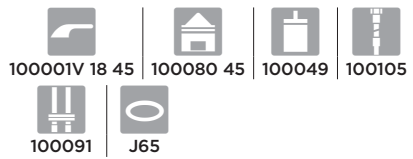

Ref.: 61201 28 45 66

Box: 1 | Carton: 10 | Pallet: 160

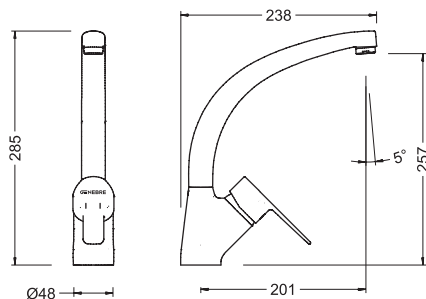
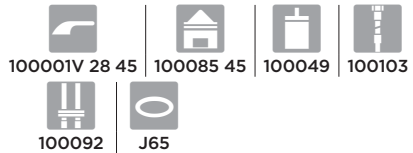

Ref.: 61210 28 45 66

Box: 1 | Carton: 8 | Pallet: 144

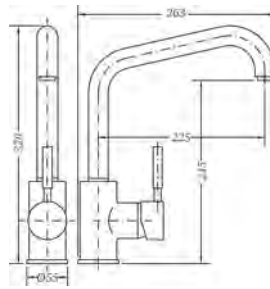
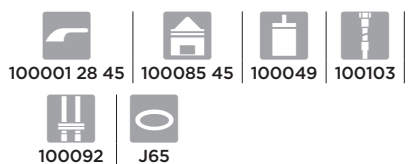

Ref.: 65204 18 45 66

Box: 1 | Carton: 5 | Pallet: 135

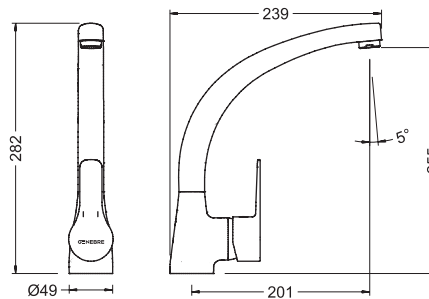
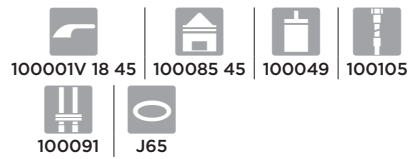

Ref.: 61203 28 45 66

Box: 1 | Carton: 8 | Pallet: 192

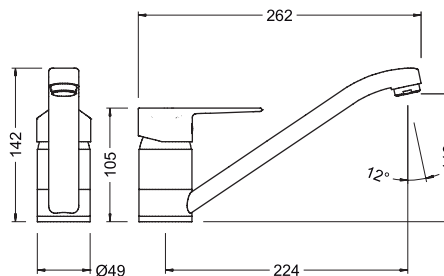

Ref.: 61200 28 45 66

Box: 1 | Carton: 9 | Pallet: 288

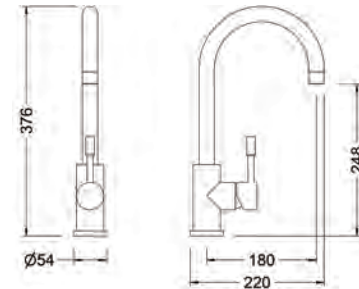
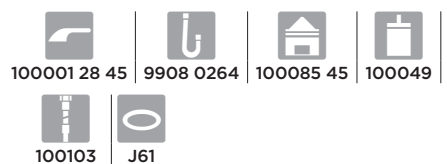

Ref.: 65203 18 60 66

Box: 1 | Carton: 5 | Pallet: 60

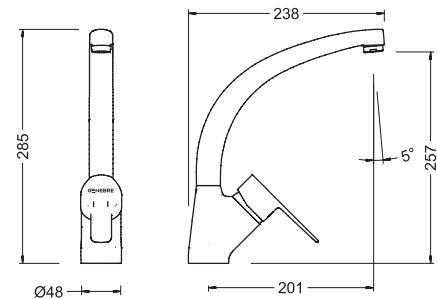

Ref.: 61204 28 45 66

Box: 1 | Carton: 8 | Pallet: 144

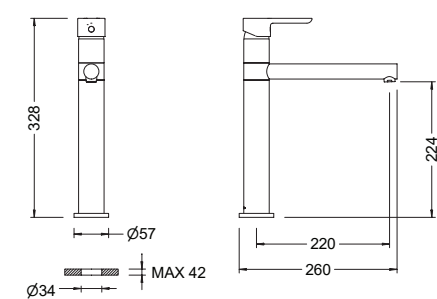

Ref.: 65200 19 45 66

Box: 1 | Carton: 10 | Pallet: 80

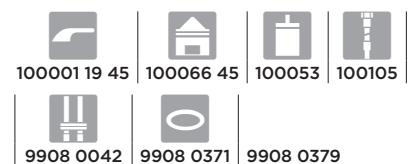

## Cocinas. Kitchen

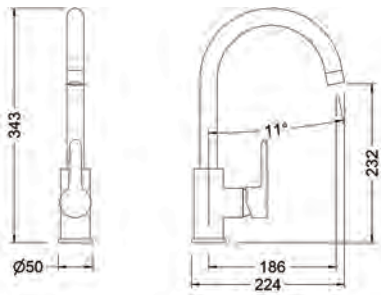

Ref.: 65203 19 45 66

Box: 1 | Carton: 8 | Pallet: 96

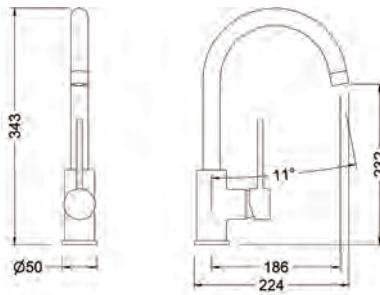

Ref.: FRT65402

Box: 1 | Carton: 8 | Pallet: 96

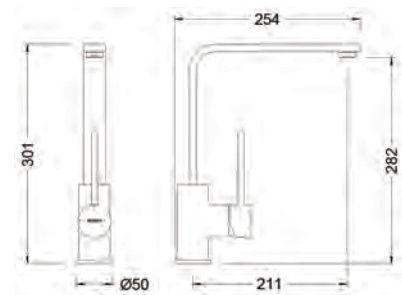

Ref.: 65404 18 45 66

Box: 1 | Carton: 8 | Pallet: 96

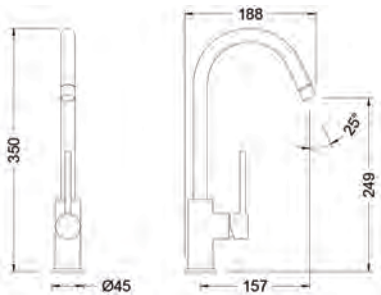
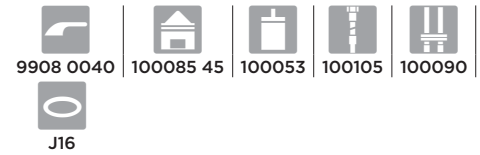

Ref.: 65403 18 45 66

Box: 1 | Carton: 8 | Pallet: 96

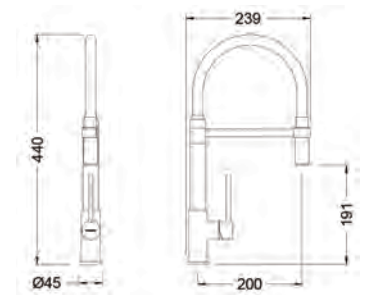
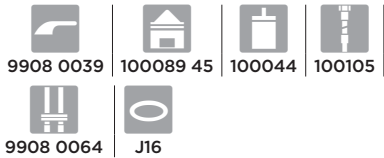

Ref.: 65219 18 45 66

Box: 1 | Carton: 4 | Pallet: 96

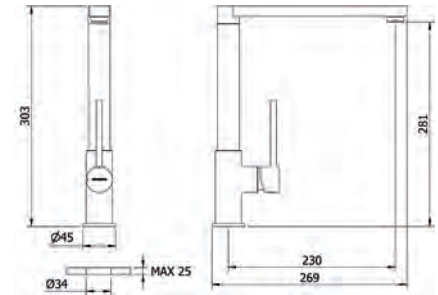
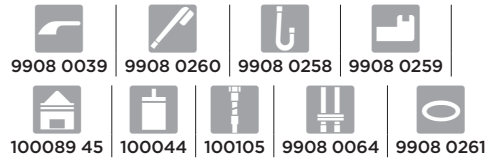

Ref.: 65215 18 45 66

Box: 1 | Carton: 8 | Pallet: 96

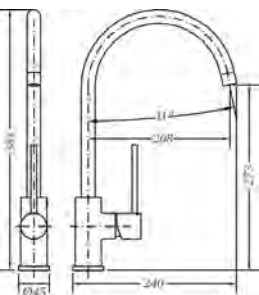
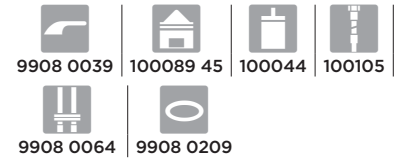

Ref.: FRT65401

Box: 1 | Carton: 8 | Pallet: 96

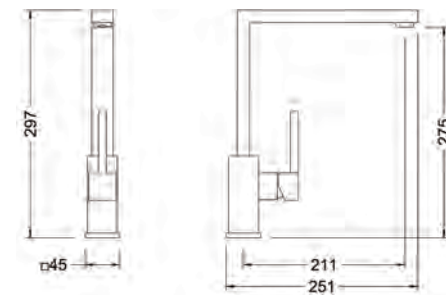
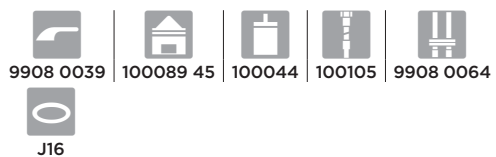

Ref.: FRK63400

Box: 1 | Carton: 8 | Pallet: 96

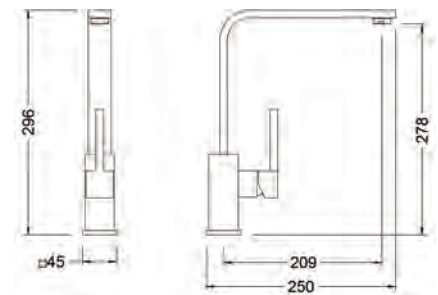
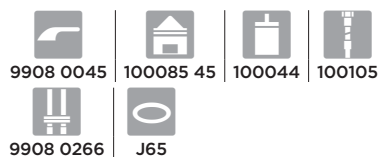

Ref.: FRK63401

Box: 1 | Carton: 8 | Pallet: 96



# Cocinas. Kitchen

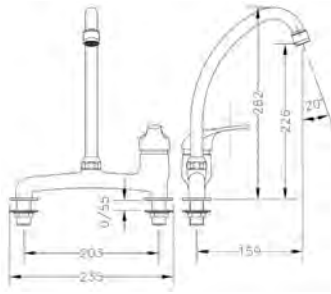

Ref.: 60198 05 45 66

Box: 1 | Carton: 6 | Pallet: 144



100001 05 45 | 100088 45 | 100053 | 100098 | J68

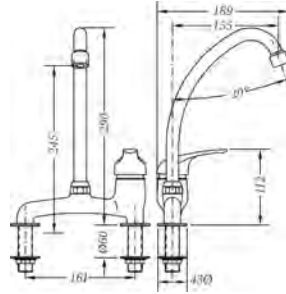

Ref.: 60199 05 45 66

Box: 1 | Carton: 12 | Pallet: 240



100001 05 45 | 100088 45 | 100053 | 100098 | J68

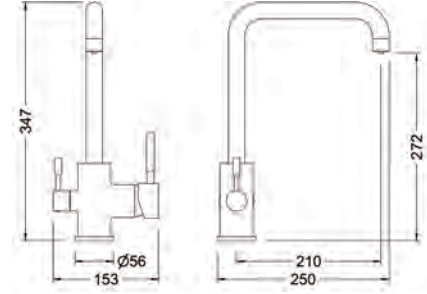

Ref.: 65702 18 45 66

Box: 1 | Carton: 4 | Pallet: 96

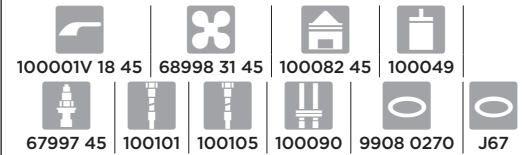

100001V 18 45 | 68998 31 45 | 100082 45 | 100049 | 67997 45 | 100101 | 100105 | 100090 | 9908 0270 | J67

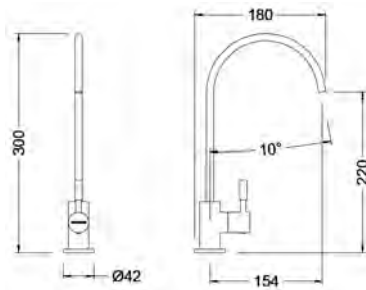

Ref.: 65700 18 45 66

Box: 1 | Carton: 14 | Pallet: 252



9908 0272 | 67998 45 | 9908 0271 | 9908 0263

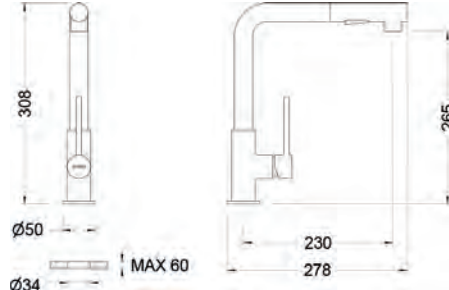

Ref.: FRV61208 44

Box: 1 | Carton: 4 | Pallet: 36

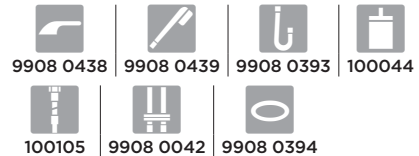

9908 0438 | 9908 0439 | 9908 0393 | 100044 | 100105 | 9908 0042 | 9908 0394

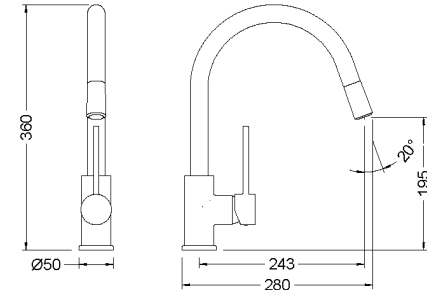

Ref.: FRV61207 44

Box: 1 | Carton: 4 | Pallet: 36

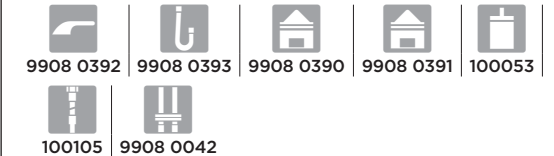

9908 0392 | 9908 0393 | 9908 0390 | 9908 0391 | 100053 | 100105 | 9908 0042

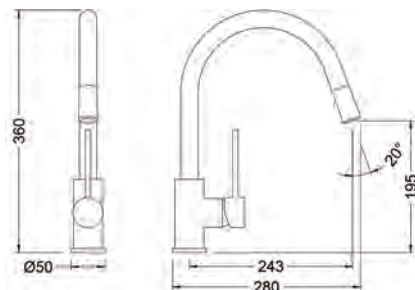

Ref.: FRV61206

Box: 1 | Carton: 4 | Pallet: 36

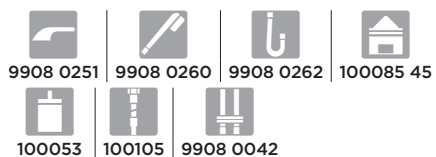

9908 0251 | 9908 0260 | 9908 0262 | 100085 45 | 100053 | 100105 | 9908 0042

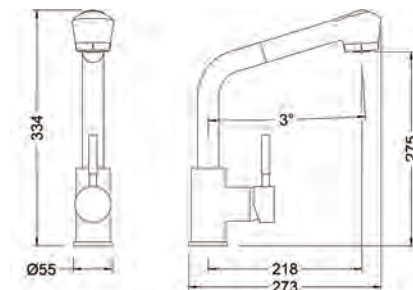

Ref.: 65205 18 45 66

Box: 1 | Carton: 6 | Pallet: 108



100001V 18 45 | 100252 45 | 100143 45 | 100085 45 | 100049 | 100105 | 100118 | 100097

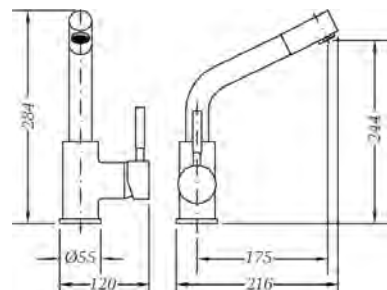

Ref.: 65206 18 45 66

Box: 1 | Carton: 8 | Pallet: 192

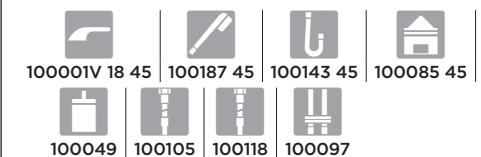

100001V 18 45 | 100187 45 | 100143 45 | 100085 45 | 100049 | 100105 | 100118 | 100097



## Cocinas. Kitchen

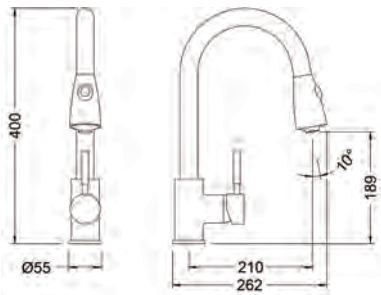

Ref.: FRV61205

Box: 1 | Carton: 4 | Pallet: 72

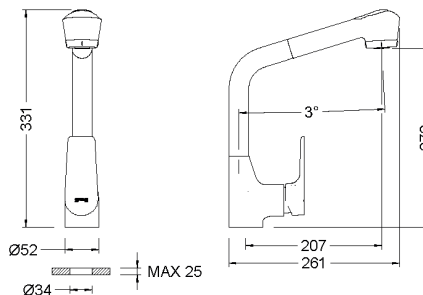
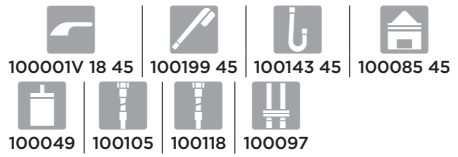

Ref.: 64206 32 45 66

Box: 1 | Carton: 6 | Pallet: 108

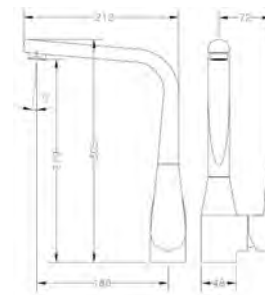
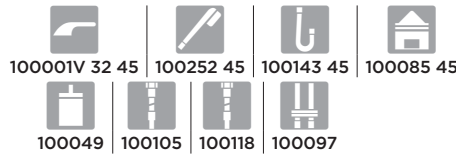

Ref.: 64201 16 45 66

Box: 1 | Carton: 8 | Pallet: 96

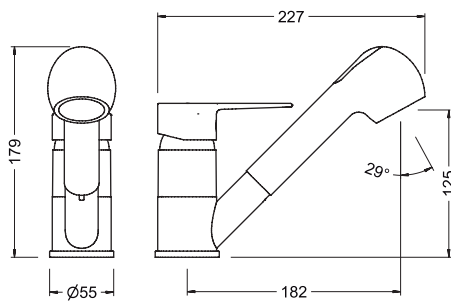
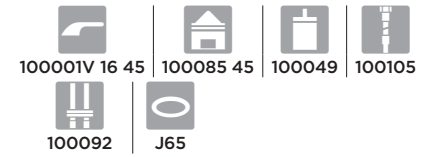

Ref.: 61205 28 45 66

Box: 1 | Carton: 10 | Pallet: 180

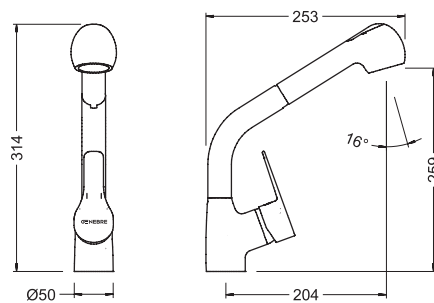
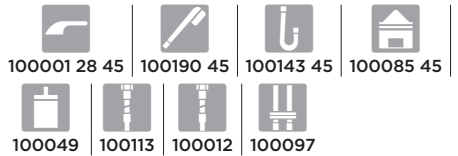

Ref.: 61206 28 45 66

Box: 1 | Carton: 10 | Pallet: 180

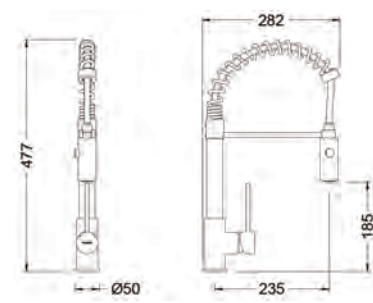
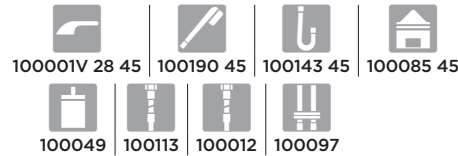

Ref.: 65211 18 45 66

Box: 1 | Carton: 4 | Pallet: 36

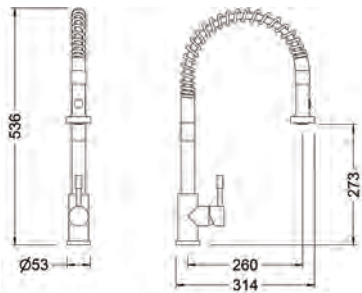
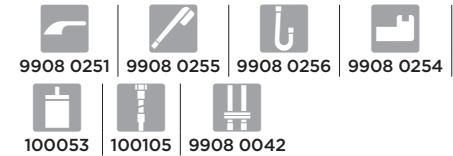

Ref.: 65207 18 60 66

Box: 1 | Carton: 4 | Pallet: 36

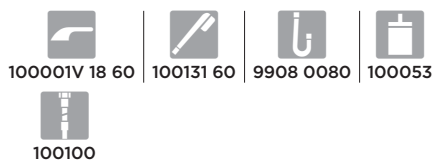

# Cocinas. Kitchen

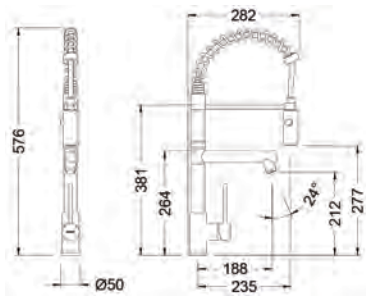

Ref.: 65212 18 45 66

Box: 1 | Carton: 4 | Pallet: 36

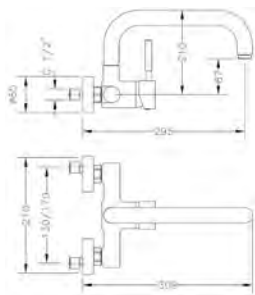

Ref.: 65192 18 45 66

Box: 1 | Carton: 4 | Pallet: 72

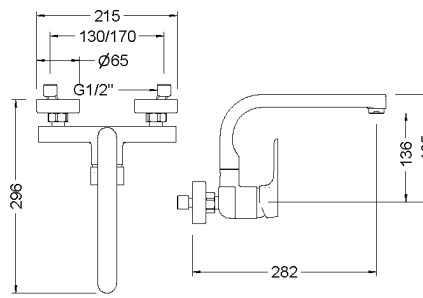

Ref.: 64192 32 45 66

Box: 1 | Carton: 6 | Pallet: 72

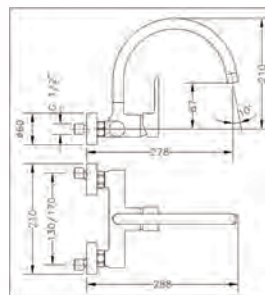
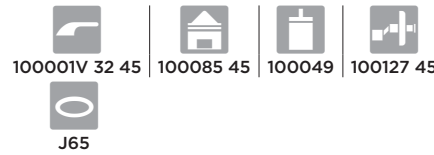

Ref.: 65192 19 45 66

Box: 1 | Carton: 6 | Pallet: 54

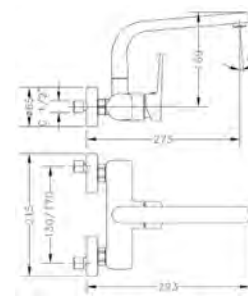
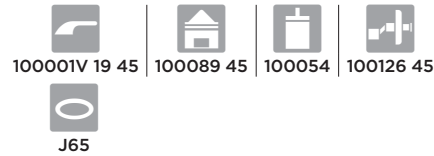

Ref.: 64192 16 45 66

Box: 1 | Carton: 6 | Pallet: 72

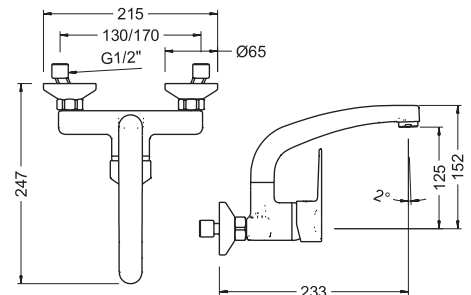
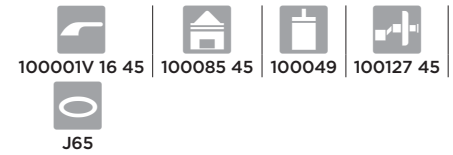

Ref.: 61190 28 45 66

Box: 1 | Carton: 10 | Pallet: 120



# Cocinas. Kitchen

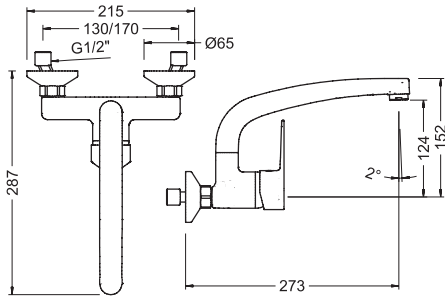

Ref.: 61192 28 45 66

Box: 1 | Carton: 4 | Pallet: 96

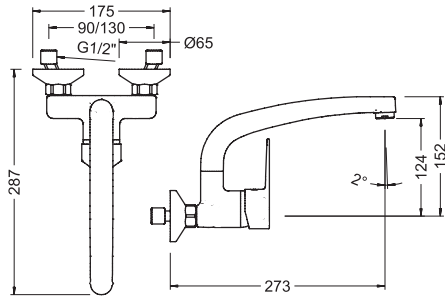

Ref.: 61195 28 45 66

Box: 1 | Carton: 6 | Pallet: 144

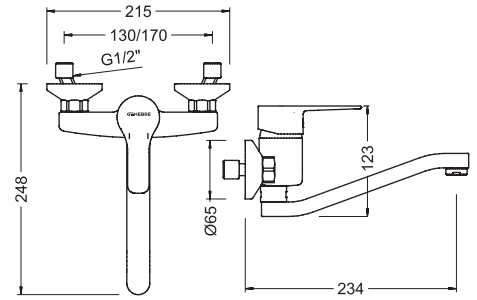

Ref.: 61196 28 45 66

Box: 1 | Carton: 8 | Pallet: 192

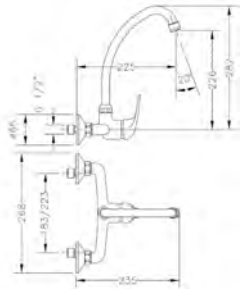
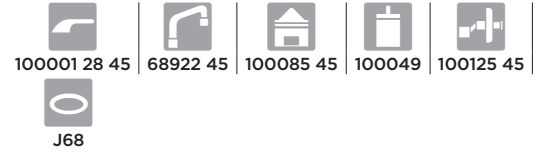

Ref.: 60194 05 45 66

Box: 1 | Carton: 8 | Pallet: 192

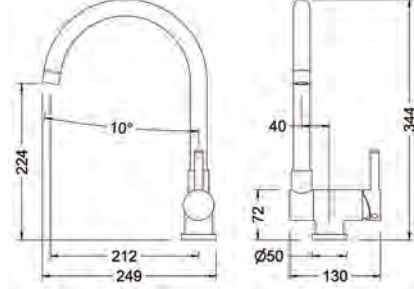

Ref.: 65900 18 45 66

Box: 1 | Carton: 8 | Pallet: 96

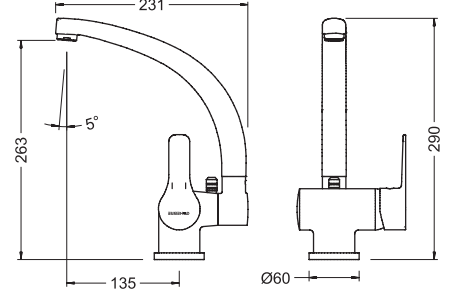

Ref.: 61900 28 45 66

Box: 1 | Carton: 6 | Pallet: 108

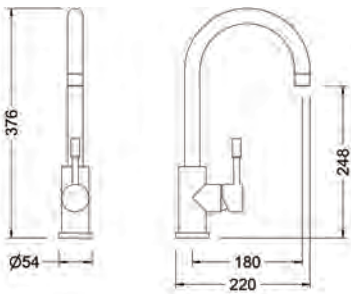
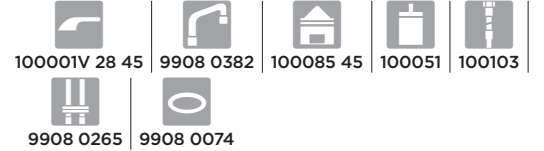

Ref.: 65203 18 60 66

Box: 1 | Carton: 5 | Pallet: 60

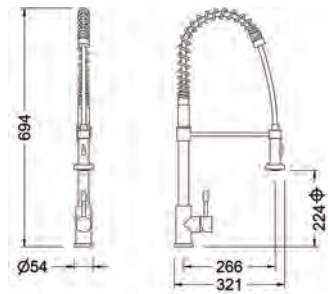

Ref.: 65211 18 60 66

Box: 1 | Carton: 4 | Pallet: 36

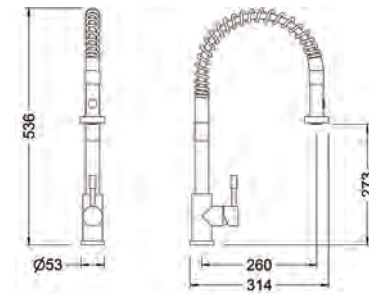
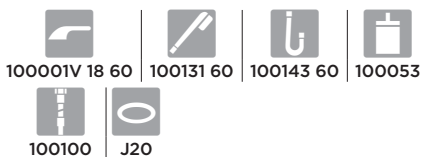

Ref.: 65207 18 60 66

Box: 1 | Carton: 4 | Pallet: 36





# Cocinas. Kitchen

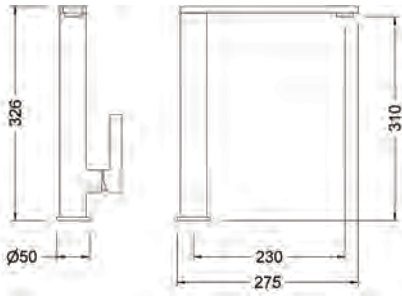

Ref.: 65215 40 60 66

Box: 1 | Carton: 4 | Pallet: 48

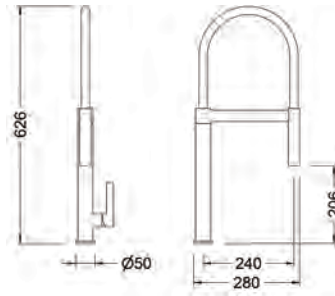
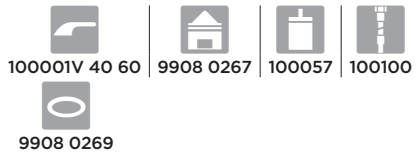

Ref.: 65219 40 60 66

Box: 1 | Carton: 4 | Pallet: 36

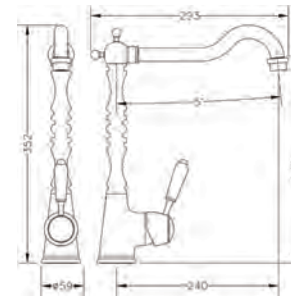
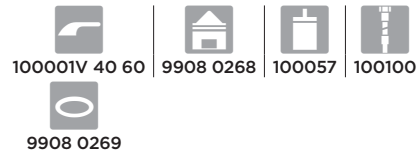

Ref.: 68201 39 43 66

Box: 1 | Carton: 4 | Pallet: 96

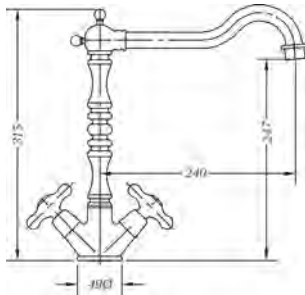
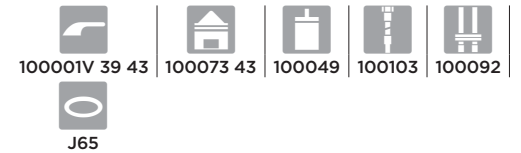

Ref.: 68595 09 45 66

Box: 1 | Carton: 4 | Pallet: 96

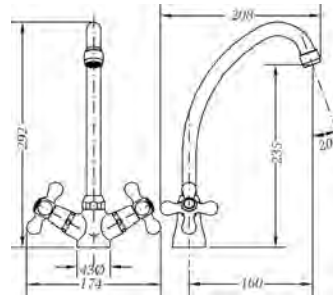
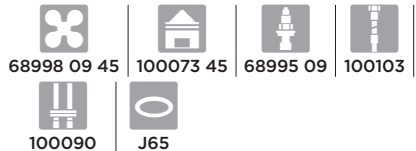

Ref.: 68540 09 45 66

Box: 1 | Carton: 10 | Pallet: 240

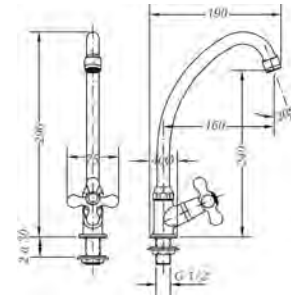
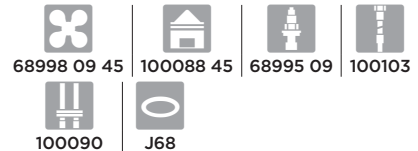

Ref.: 68585 09 45 66

Box: 1 | Carton: 10 | Pallet: 240

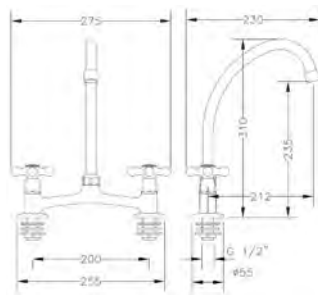

Ref.: 68545 09 45 66

Box: 1 | Carton: 10 | Pallet: 240

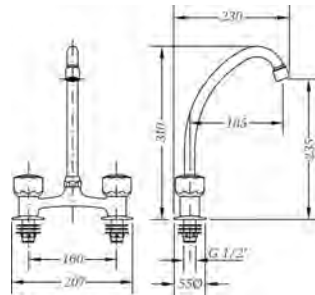

Ref.: 68194 11 45 66

Box: 1 | Carton: 10 | Pallet: 240

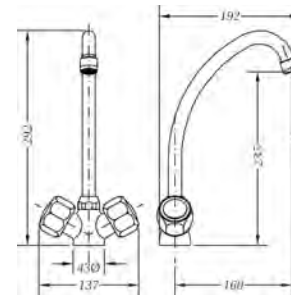
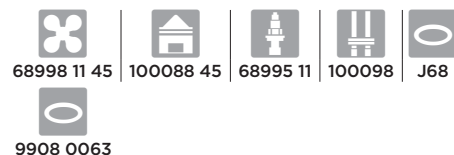

Ref.: 68200 11 45 66

Box: 1 | Carton: 10 | Pallet: 240

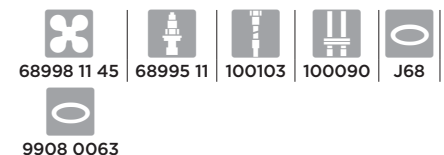

## Cocinas. Kitchen

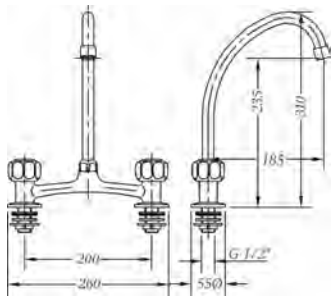

Ref.: 68199 11 45 66

Box: 1 | Carton: 10 | Pallet: 240

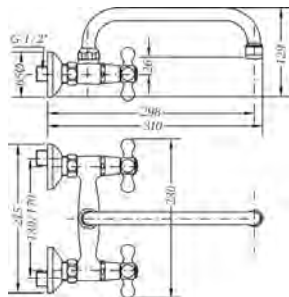
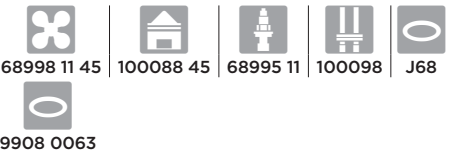

Ref.: 68555 09 45 66

Box: 1 | Carton: 10 | Pallet: 240

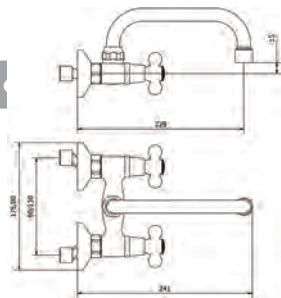

Ref.: 68550 09 45 66

Box: 1 | Carton: 10 | Pallet: 240

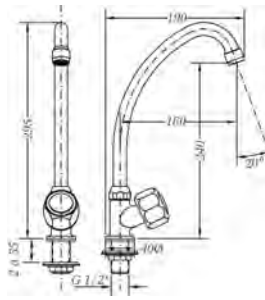
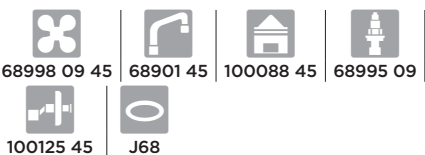

Ref.: 68003 11 45 66

Box: 1 | Carton: 10 | Pallet: 240

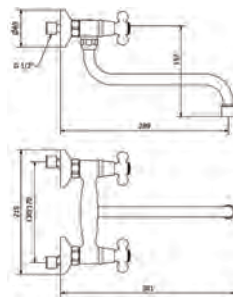
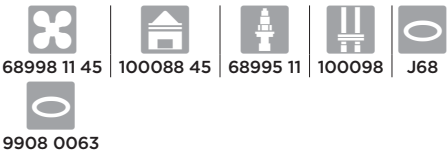

Ref.: 68560 09 45 66

Box: 1 | Carton: 10 | Pallet: 240

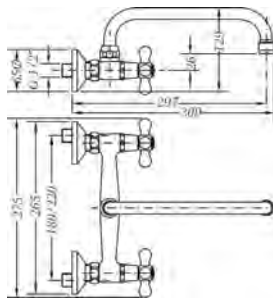
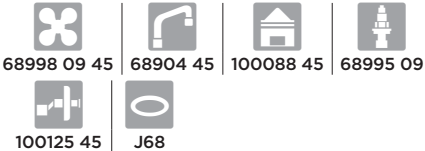

Ref.: 68565 09 45 66

Box: 1 | Carton: 10 | Pallet: 240

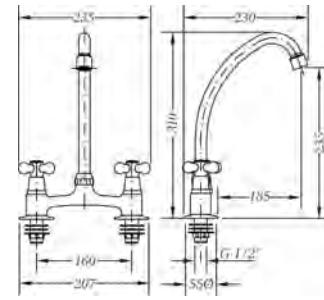
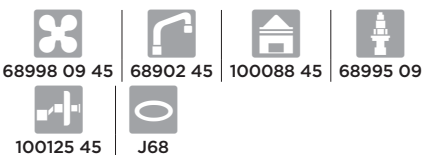

Ref.: 68194 09 45 66

Box: 1 | Carton: 10 | Pallet: 240

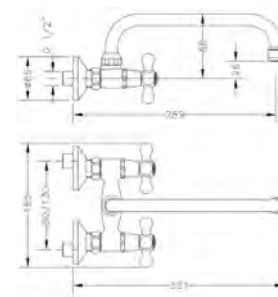
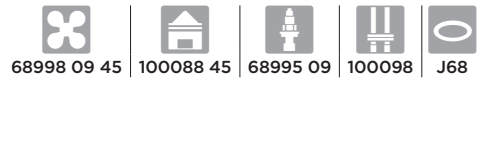

Ref.: 68196 09 45 66

Carton: 1

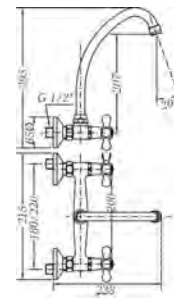

Ref.: 68570 09 45 66

Box: 1 | Carton: 10 | Pallet: 240



# Cocinas. Kitchen

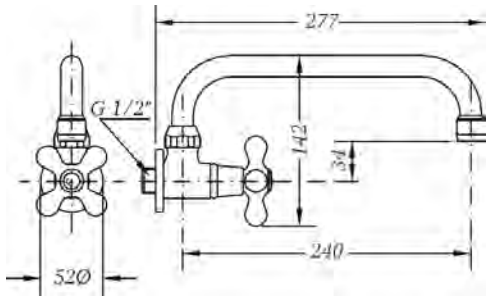

Ref.: 68580 09 45 66

Box: 1 | Carton: 10 | Pallet: 240



68998 09 45 | 68902 45 | 100088 45 | 68995 09 | J68

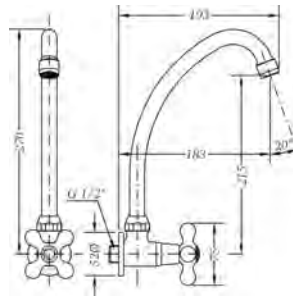

Ref.: 68575 09 45 66

Box: 1 | Carton: 10 | Pallet: 240



68998 09 45 | 100088 45 | 68995 09 | J68

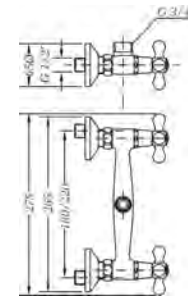

Ref.: 568565 45

Box: 1 | Carton: 15 | Pallet: 270



68998 09 45 | 68995 09 | 100125 45

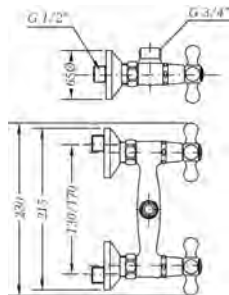

Ref.: 568555 45

Box: 1 | Carton: 15 | Pallet: 270



68998 09 45 | 68995 09 | 100125 45

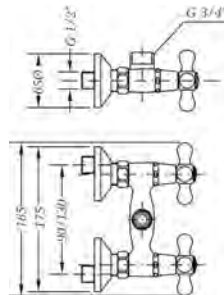

Ref.: 568550 45

Box: 1 | Carton: 15 | Pallet: 270



68998 09 45 | 68995 09 | 100125 45

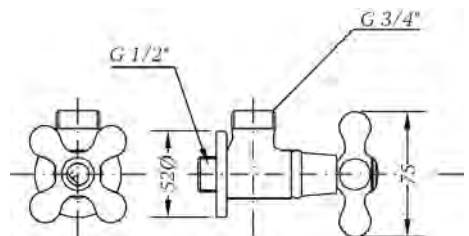

Ref.: 568575 45

Box: 1 | Carton: 15 | Pallet: 270



68998 09 45 | 68995 09

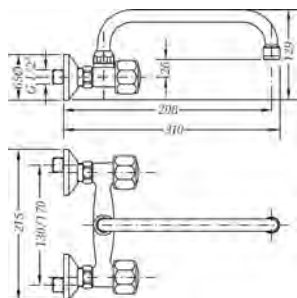

Ref.: 68193 11 45 66

Box: 1 | Carton: 10 | Pallet: 240

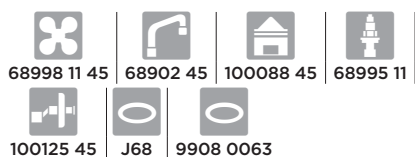

68998 11 45 | 68902 45 | 100088 45 | 68995 11 | 100125 45 | J68 | 9908 0063

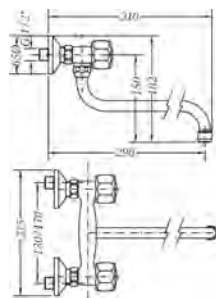

Ref.: 68197 11 45 66

Box: 1 | Carton: 10 | Pallet: 240

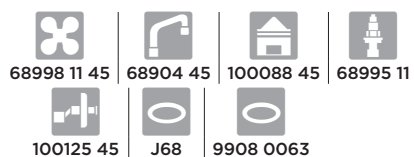

68998 11 45 | 68904 45 | 100088 45 | 68995 11 | 100125 45 | J68 | 9908 0063

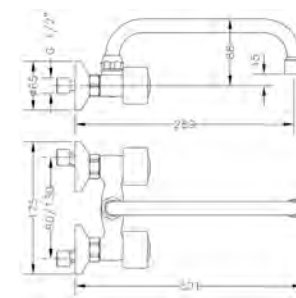

Ref.: 68196 11 45 66

Box: 1 | Carton: 10 | Pallet: 270

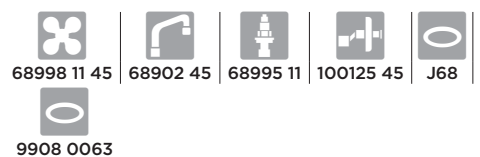

68998 11 45 | 68902 45 | 68995 11 | 100125 45 | J68 | 9908 0063



## Cocinas. Kitchen

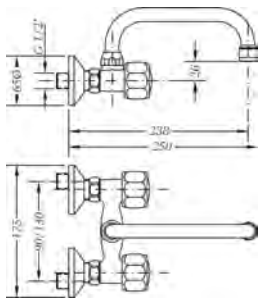

Ref.: 68195 11 45 66

Box: 1 | Carton: 17 | Pallet: 204

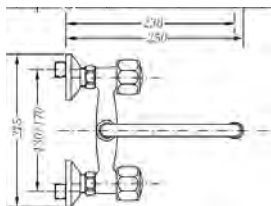
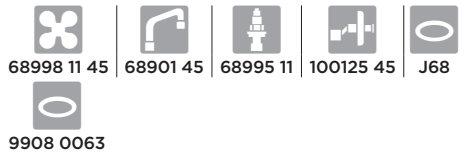

Ref.: 68190 11 45 66

Box: 1 | Carton: 17 | Pallet: 204

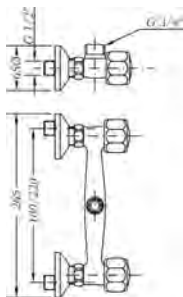
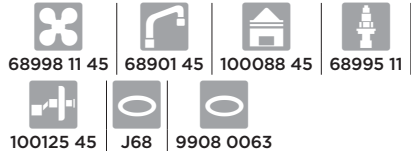

Ref.: 568104 45

Box: 1 | Carton: 15 | Pallet: 240

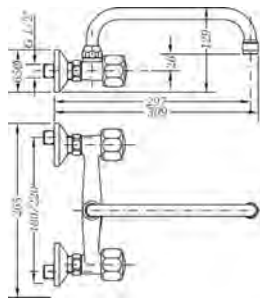

Ref.: 68104 11 45 66

Box: 1 | Carton: 10 | Pallet: 240

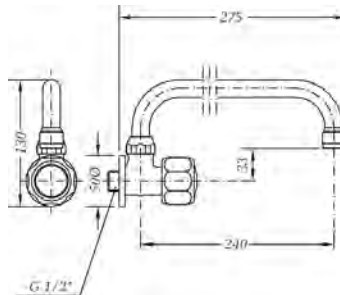

Ref.: 68093 11 45 66

Box: 1 | Carton: 10 | Pallet: 240

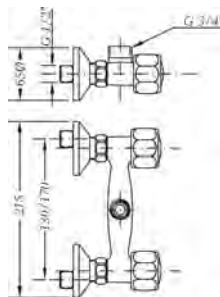

Ref.: 568193 45

Box: 1 | Carton: 20 | Pallet: 360

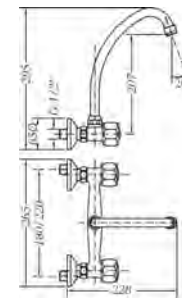
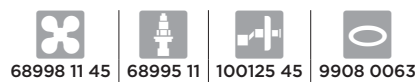

Ref.: 68103 11 45 66

Box: 1 | Carton: 10 | Pallet: 240

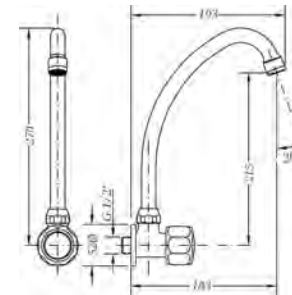
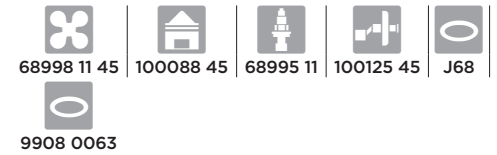

Ref.: 68083 11 45 66

Box: 1 | Carton: 19 | Pallet: 228

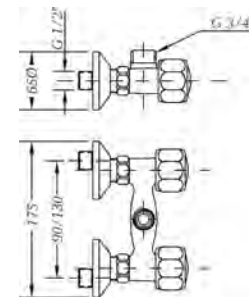

Ref.: 568195 45

Box: 1 | Carton: 20 | Pallet: 360



# Cocinas. Kitchen

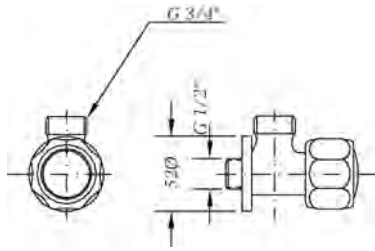

Ref.: 568083 45

Box: 1 | Carton: 40 | Pallet: 960

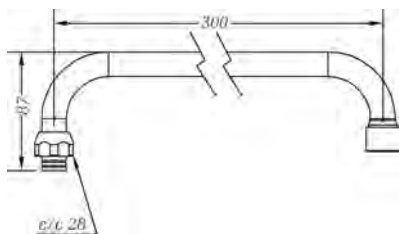

Ref.: 68908 45

Box: 1 | Carton: 40 | Pallet: 720

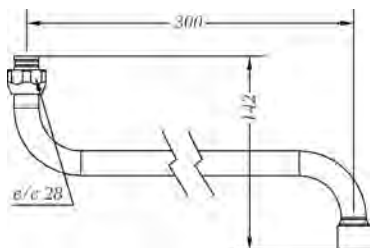

Ref.: 68909 45

Box: 1 | Carton: 40 | Pallet: 480

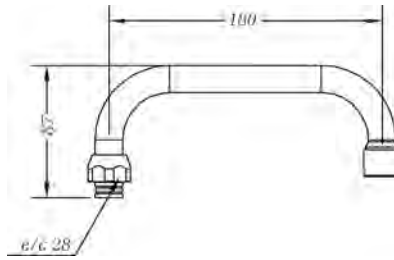

Ref.: 68901 45

Box: 1 | Carton: 40 | Pallet: 720

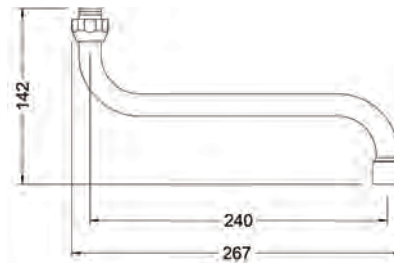

Ref.: 68904 45

Box: 1 | Carton: 30 | Pallet: 540

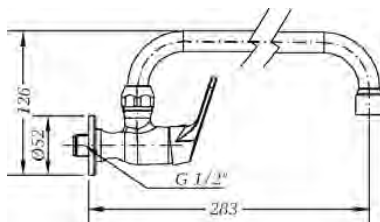

Ref.: 1008 04

Box: 1 | Carton: 42 | Pallet: 504

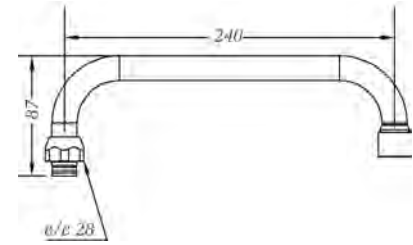
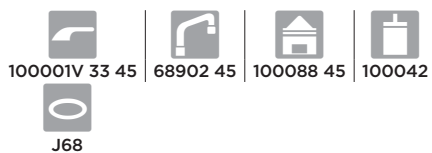

Ref.: 68902 45

Box: 1 | Carton: 30 | Pallet: 540

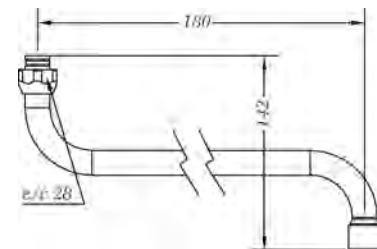

Ref.: 68910 45

Box: 1 | Carton: 40 | Pallet: 720

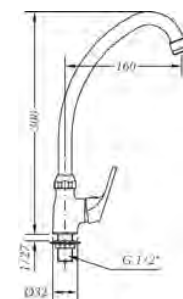

Ref.: 1009 04

Box: 1 | Carton: 30 | Pallet: 540



## Cocinas. Kitchen

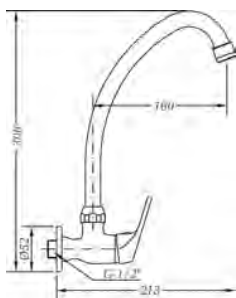

Ref.: 1005 04

Box: 1 | Carton: 42 | Pallet: 504

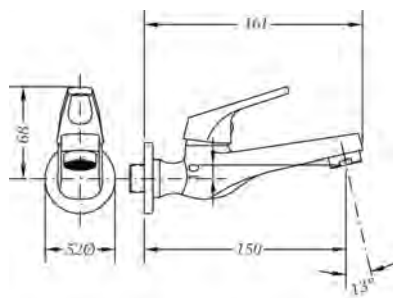

Ref.: 1003 04

Box: 1 | Carton: 48 | Pallet: 864

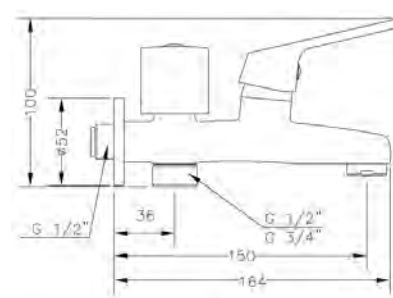

Ref.: 1024 04

Box: 1 | Carton: 22 | Pallet: 704

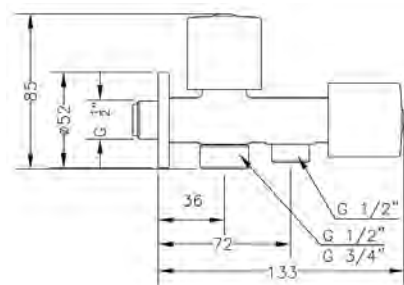
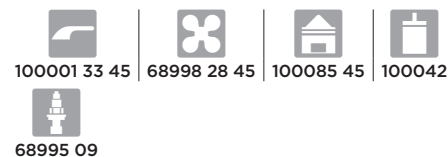

Ref.: 1023 04

Box: 1 | Carton: 48 | Pallet: 864

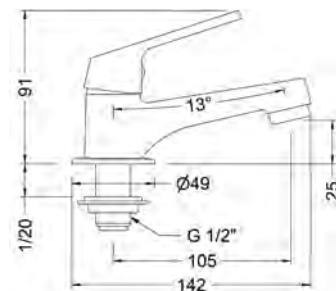

Ref.: 1002 04

Box: 1 | Carton: 42 | Pallet: 840

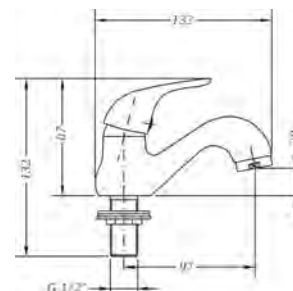

Ref.: 1007 04

Box: 1 | Carton: 22 | Pallet: 704

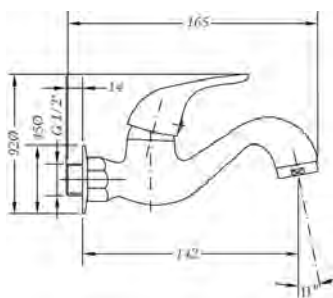

Ref.: 1006 04

Box: 1 | Carton: 36 | Pallet: 864





## Accesorios. Accessories

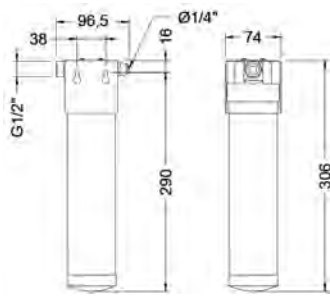

Ref.: FT00

Box: 1 | Carton: 16 | Pallet: 160

FT92

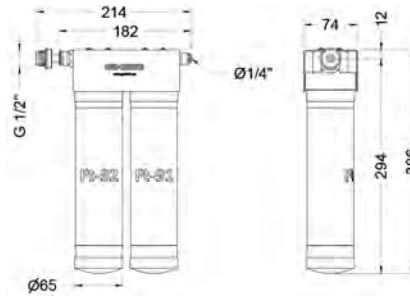

Ref.: FT01

Box: 1 | Carton: 8 | Pallet: 100



FT91 | FT92

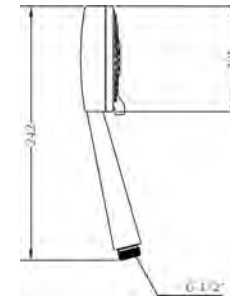

Ref.: DXK3 45

Box: 1 | Carton: 36 | Pallet: 324



Ref.: 9908 0284

Box: 1 | Carton: 25 | Pallet: 225

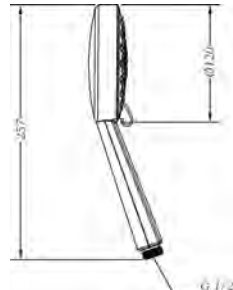

Ref.: DXT5 45

Box: 1 | Carton: 24 | Pallet: 288

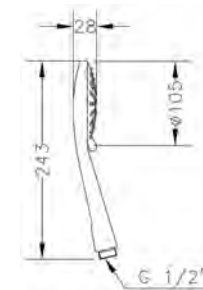

Ref.: DXT3 45

Box: 1 | Carton: 36 | Pallet: 324

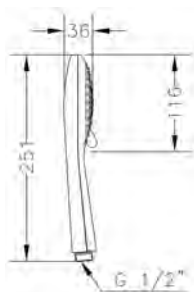

Ref.: DXO3 45

Box: 1 | Carton: 36 | Pallet: 324

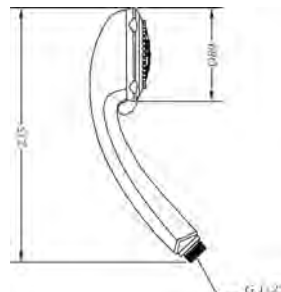

Ref.: DXE5 45

Box: 1 | Carton: 45 | Pallet: 405

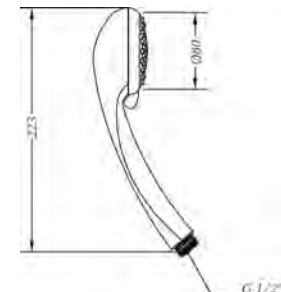

Ref.: DXE2 45

Box: 1 | Carton: 45 | Pallet: 540

## Accesorios. Accessories

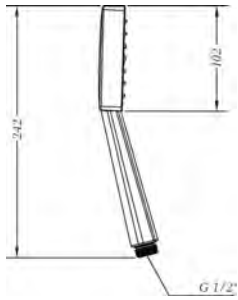

Ref.: DXK1 45

Box: 1 | Carton: 36 | Pallet: 432

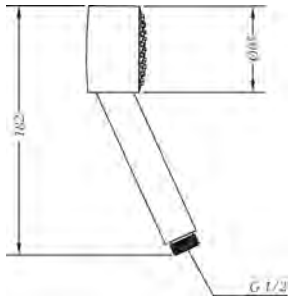

Ref.: 100197 45 00

| Carton: 100 Pallet: 1600

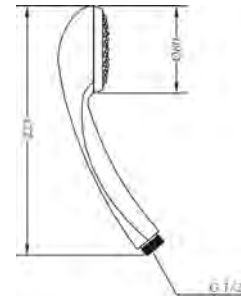

Ref.: 100175 45 00

| Carton: 40 Pallet: 1280

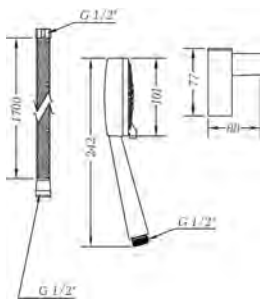

Ref.: 100698 45

Box: 1 | Carton: 18 | Pallet: 216

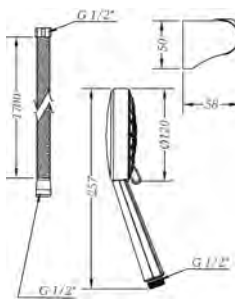

Ref.: 100699 45

Box: 1 | Carton: 18 | Pallet: 216

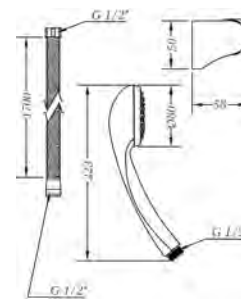

Ref.: 100697 45

Box: 1 | Carton: 18 | Pallet: 216



Ref.: 1748 45

Box: 1 | Carton: 10 | Pallet: 60

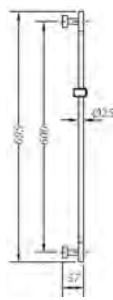

Ref.: 1747 45

Box: 1 | Carton: 10 | Pallet: 60

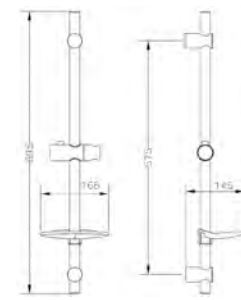

Ref.: 1636 45

Box: 1 | Carton: 10 | Pallet: 80



Ref.: 1637 45

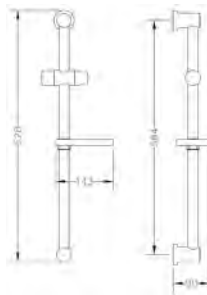

Ref.: 1638 45

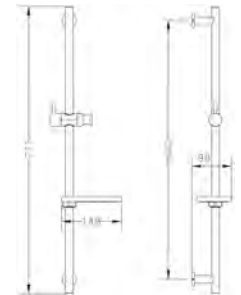

Ref.: 1639 45

## Accesorios. Accessories

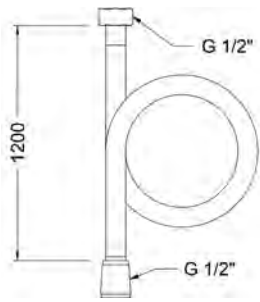

Ref.: 100141 45

| Carton: 50 | Pallet: 900

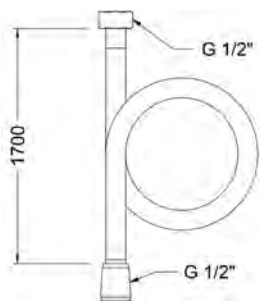

Ref.: 100140 30

Box: 1 | Carton: 24 | Pallet: 432

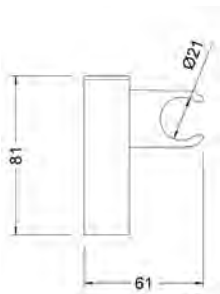

Ref.: 100149 45

| Carton: 60 | Pallet: 1080



Ref.: 1633 04

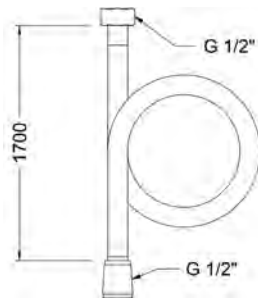

Ref.: 100135 60 00

| Carton: 35 | Pallet: 1120

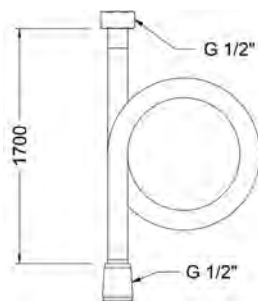

Ref.: 9908 0287

| Carton: 35 Pallet: 1120

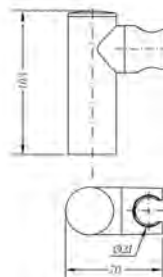

Ref.: 100153 45

Ref.: 1634 04

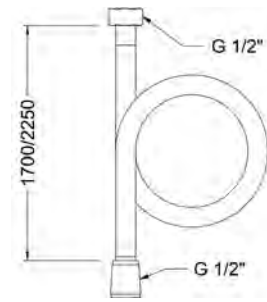

Ref.: 100137 60 00

| Carton: 35 | Pallet: 1120

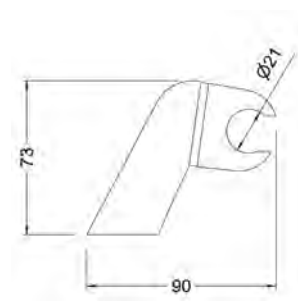

Ref.: 100152 45 00

| Carton: 150 | Pallet: 2700

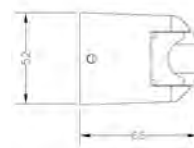

Ref.: 100068 45

| Carton: 150 | Pallet: 1800

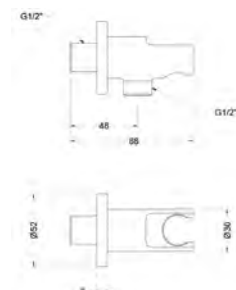

Ref.: 1946 41



## Accesorios. Accessories



**Ref.: 1635 04**  
**Box: 1 | Carton: 50 | Pallet: 1600**

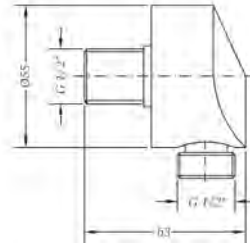

**Ref.: 1680 04**  
**Box: 1 | Carton: 60 | Pallet: 1920**

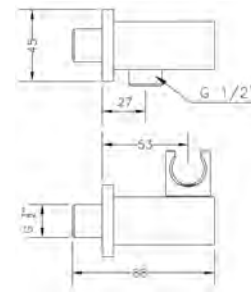

**Ref.: 1649 04**  
**Box: 1 | Carton: 50 | Pallet: 1600**



**Ref.: 1679 04**  
**Box: 1 | Carton: 40 | Pallet: 1600**

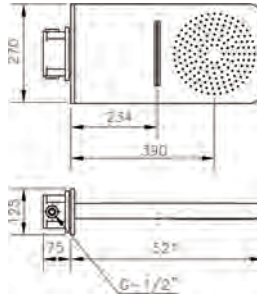

**Ref.: 1643 45**  
**Box: 1 | Carton: 2 | Pallet: 12**

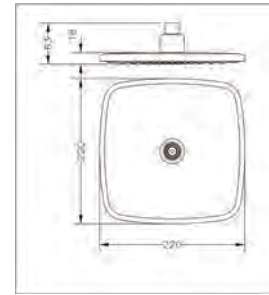

**Ref.: R63112 08**  
**Box: 1 | Carton: 24 | Pallet: 192**

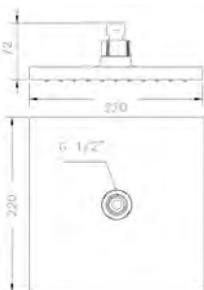

**Ref.: R63112 26**  
**Box: 1 | Carton: 24 | Pallet: 144**

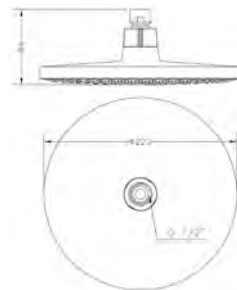

**Ref.: R65112 18**  
**Box: 1 | Carton: 24 | Pallet: 144**



**Ref.: R65112 41**  
**Box: 1 | Carton: 12 | Pallet: 192**

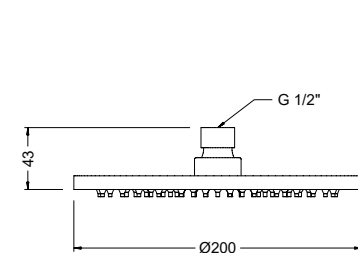

**Ref.: R68113 43**

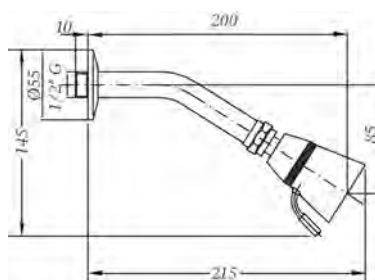

**Ref.: 1698 45 00**

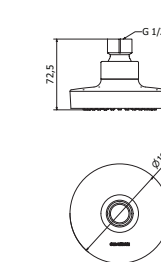

**Ref.: 1155 04**

## Accesorios. Accessories

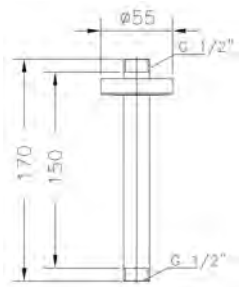

Ref.: 1671 45  
Box: 1 | Carton: 20 | Pallet: 960

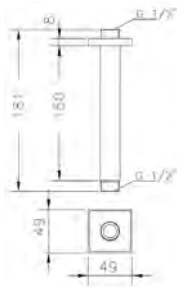

Ref.: 1672 45  
Box: 1 | Carton: 54 | Pallet: 1728

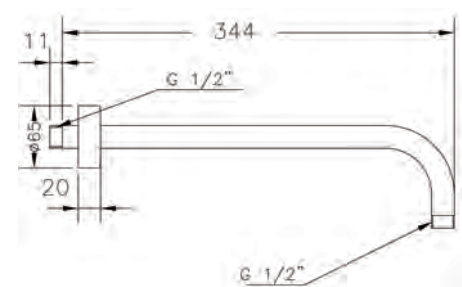

Ref.: B65113 18  
Box: 1 | Carton: 20 | Pallet: 480

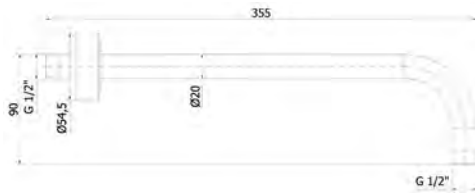

Ref.: B64113 41  
Box: 1 | Carton: 20 | Pallet: 600



Ref.: B64113 43  
Box: 1 | Carton: 20 | Pallet: 600

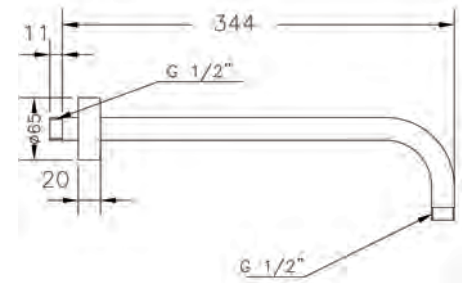

Ref.: B65114 18  
Box: 1 | Carton: 42 | Pallet: 1260

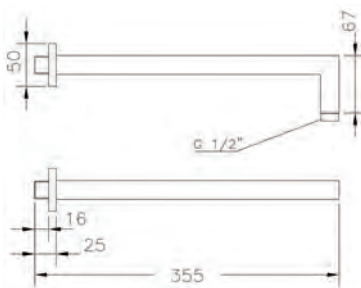

Ref.: B63113 26  
Box: 1 | Carton: 20 | Pallet: 360

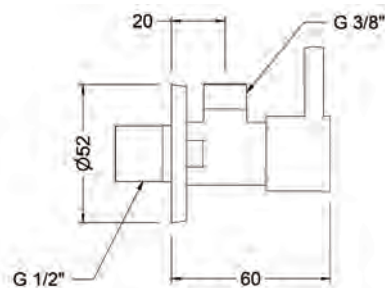

Ref.: 3104 04  
Box: 2 | Carton: 132 | Pallet: 4224

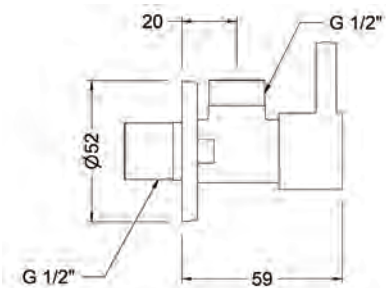

Ref.: 3110 04 41  
Box: 1 | Carton: 40 | Pallet: 960

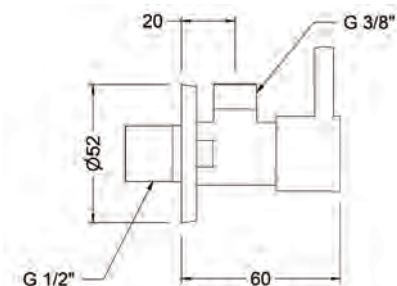

Ref.: 3110 03 41

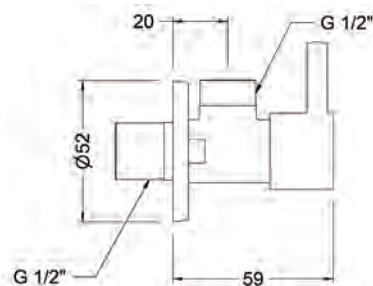

Ref.: 3104 05

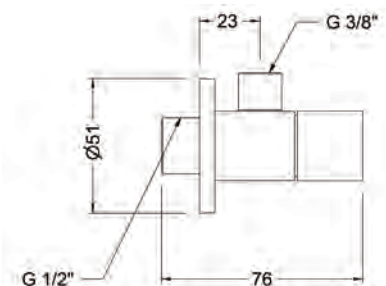

Ref.: 3106 04

## Accesorios. Accessories

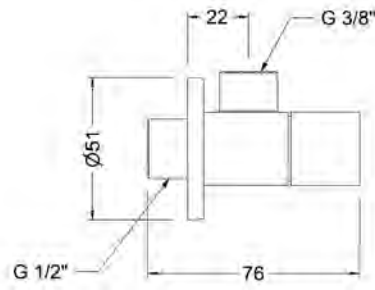

**Ref.: 3106 05**  
**Box: 2 | Carton: 120 | Pallet: 4320**

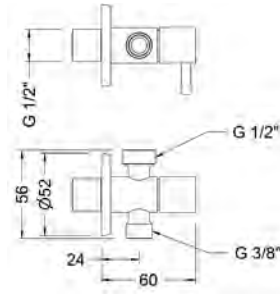

**Ref.: 3107 03**  
**Carton: 1**

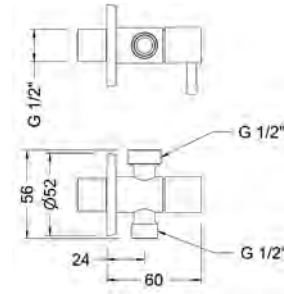

**Ref.: 3107 04**  
**Box: 1 | Carton: 160**

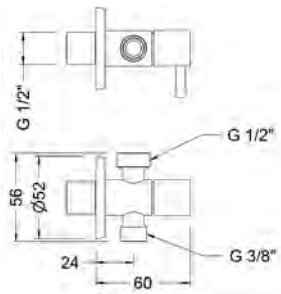

**Ref.: 3108 03**  
**Box: 1 | Carton: 160**

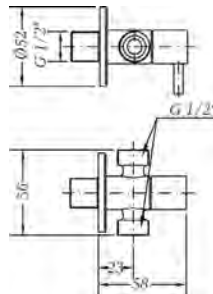

**Ref.: 3108 04**  
**Box: 1 | Carton: 160**

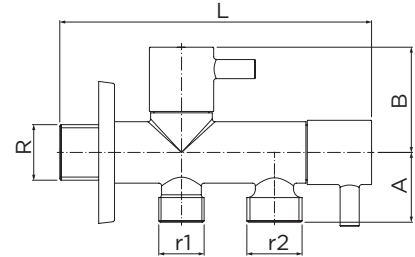

**Ref.: 3109 04**  
**Box: 1 | Carton: 90 | Pallet: 2160**

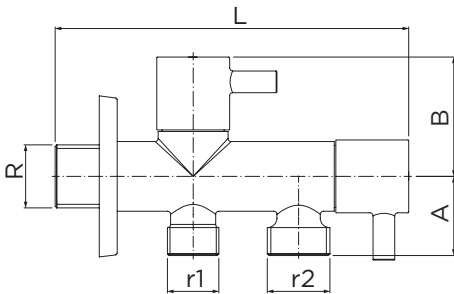

**Ref.: 3109 05**  
**Box: 1 | Carton: 60 | Pallet: 2160**

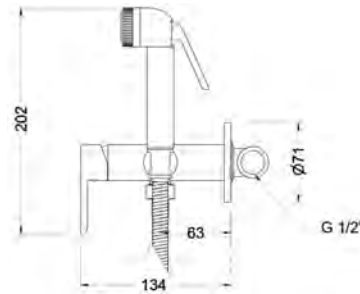

**Ref.: 65144 19 45 66**  
**Box: 1 | Carton: 18 | Pallet: 288**

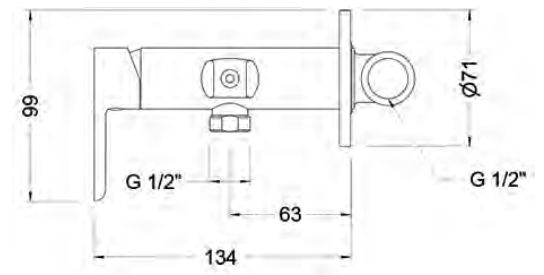

**Ref.: 65144 19 45 67**  
**Box: 1 | Carton: 20 | Pallet: 640**

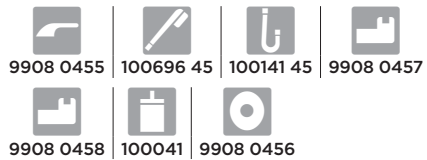



## Accesorios. Accessories

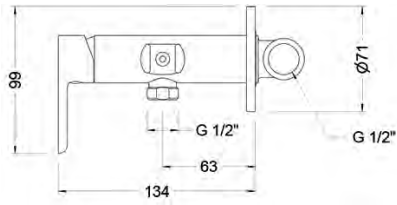

Ref.: 65144 19 41 67

Box: 1 | Carton: 20 | Pallet: 640



9908 0459 | 9908 0461 | 100041 | 9908 0462



9908 0460



Ref.: 100694 41

Box: 1 | Carton: 22 | Pallet: 264

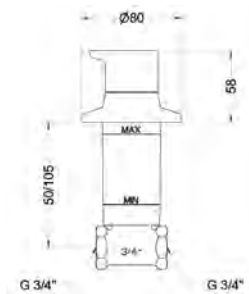

Ref.: 60171 41 45 66

Box: 1 | Carton: 8 | Pallet: 192



9908 0451 | 9908 0454 | 9908 0453 | 9908 0452

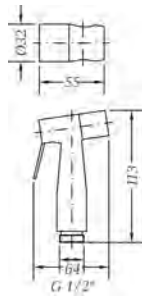

Ref.: 100694 45

Box: 1 | Carton: 22 | Pallet: 264

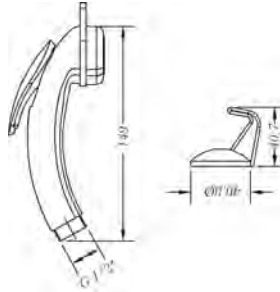

Ref.: 100696 45

Carton: 100 | Pallet: 1800

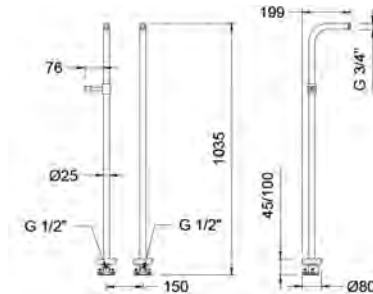

Ref.: 65120 45

Box: 1 | Carton: 2 | Pallet: 24



Ref.: 100694 60

Box: 1 | Carton: 22 | Pallet: 264

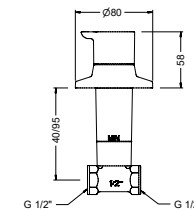

Ref.: 60170 41 45 66

Box: 1 | Carton: 8 | Pallet: 192



9908 0451 | 9908 0450 | 9908 0453 | 9908 0452

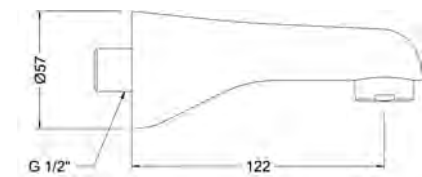

Ref.: 1667 45

Box: 1 | Carton: 60 | Pallet: 1080

## Accesorios. Accessories

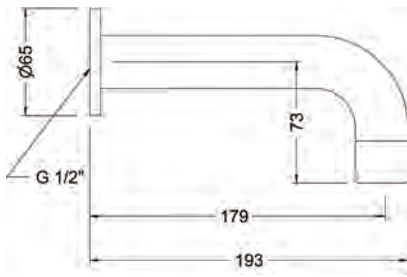

Ref.: 1668 45  
Box: 1 | Carton: 20 | Pallet: 600

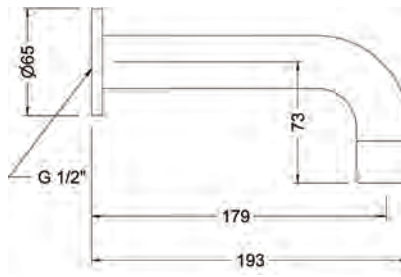

Ref.: 1668 41  
Box: 1 | Carton: 21 | Pallet: 360

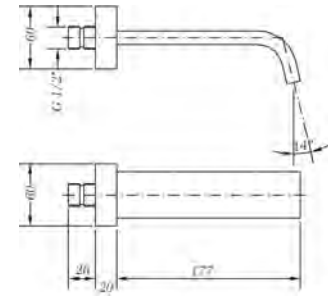

Ref.: 1674 45  
Box: 1 | Carton: 24 | Pallet: 720

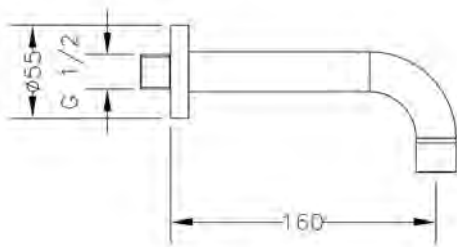

Ref.: 68911 45  
Box: 1 | Carton: 40 | Pallet: 640



9908 0433

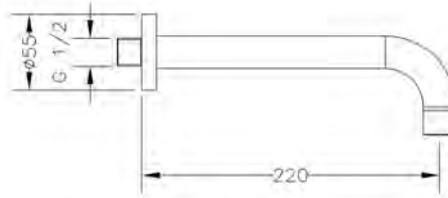

Ref.: 68912 45  
Box: 1 | Carton: 40 | Pallet: 640



9908 0433

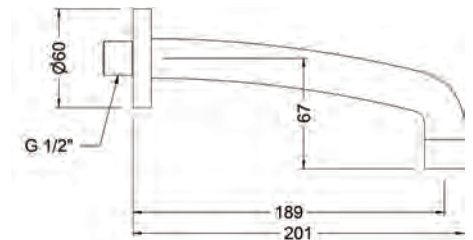

Ref.: 68913 45  
Box: 1 | Carton: 24 | Pallet: 768



9908 0433

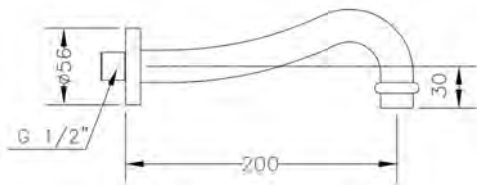

Ref.: 68914 45  
Box: 1 | Carton: 24 | Pallet: 768

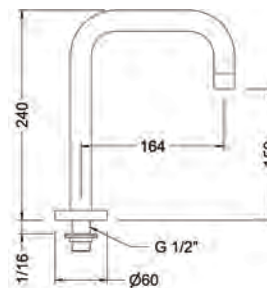

Ref.: 68915 45  
Box: 1 | Carton: 30 | Pallet: 360



9908 0433 | 100098

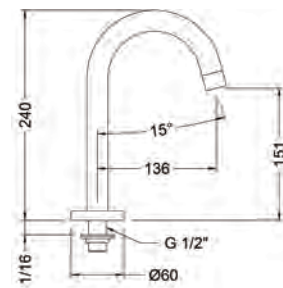

Ref.: 68916 45  
Box: 1 | Carton: 30 | Pallet: 360



9908 0433 | 100098

## Accesorios. Accessories

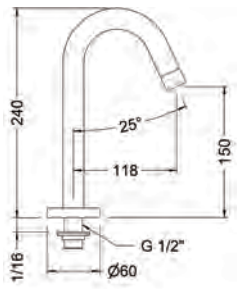

Ref.: 68917 45

Box: 1 | Carton: 30 | Pallet: 360



9908 0433 | 100098

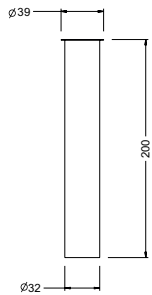

Ref.: 1632 41

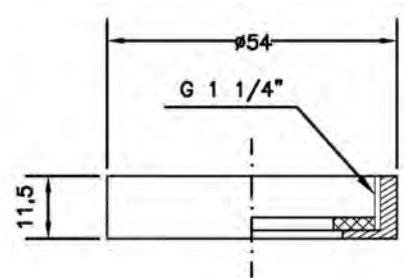

Ref.: 100134 07

Box: 30 | Carton: 240 | Pallet: 8640

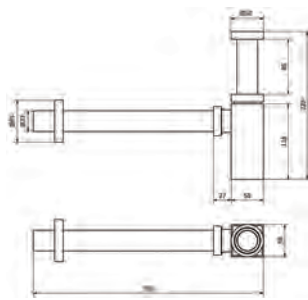

Ref.: 1621 07

Box: 1 | Carton: 12 | Pallet: 216

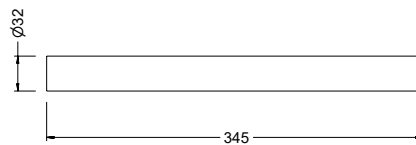

Ref.: 1640 41

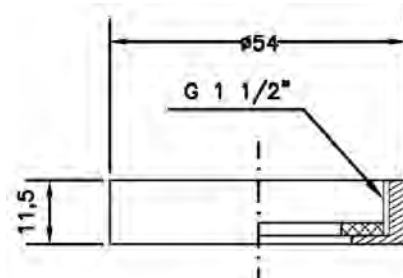

Ref.: 100134 08

Carton: 1

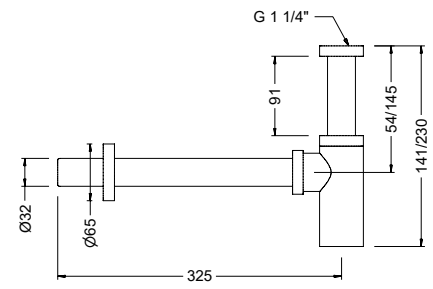

Ref.: 1622 07

Box: 1 | Carton: 12 | Pallet: 216

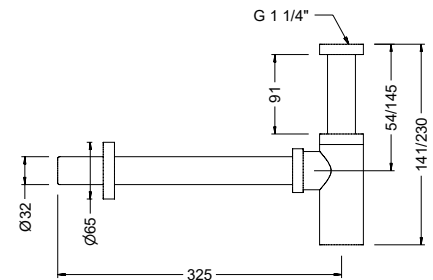

Ref.: 1626 41

Box: 1 | Carton: 12 | Pallet: 216

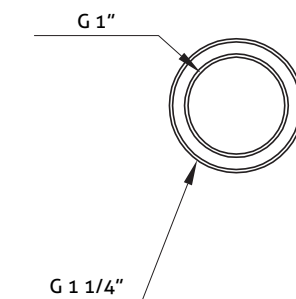

Ref.: 9908 0046

Carton: 1



## Accesorios. Accessories

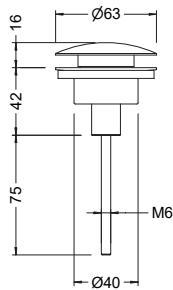

Ref.: 100202 45

Box: 1 | Carton: 60 | Pallet: 1080



9908 0153 | J100206 | 9908 0156 | 9908 0162

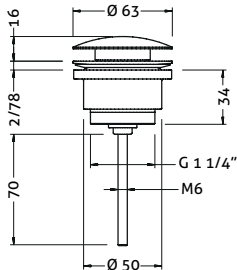

Ref.: 100211 45

Box: 1 | Carton: 60 | Pallet: 1080



9908 0153 | J100206 | 9908 0156 | 9908 0162

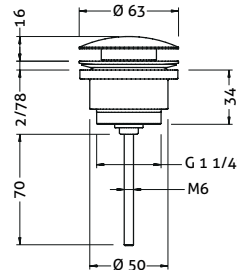

Ref.: 100211 41

Box: 1 | Carton: 60 | Pallet: 1080



9908 0153 | J100206 | 9908 0156 | 9908 0348

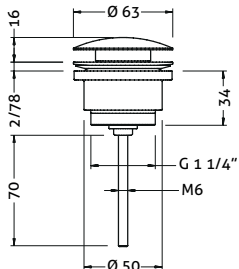

Ref.: 100211 43

Box: 1 | Carton: 60 | Pallet: 1080



9908 0153 | J100206 | 9908 0156 | 9908 0163

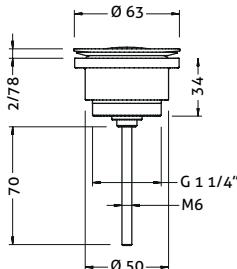

Ref.: 100205 45

Box: 1 | Carton: 60 | Pallet: 1080



9908 0153 | J100206 | 9908 0155 | 9908 0165

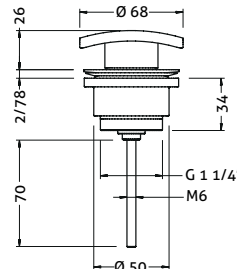

Ref.: 100204 45

Box: 1 | Carton: 60 | Pallet: 1080



9908 0153 | J100206 | 9908 0156 | 9908 0164

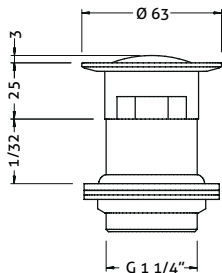

Ref.: 100206 45

Box: 1 | Carton: 60 | Pallet: 1080



9908 0152 | J100206 | 9908 0157 | 9908 0168

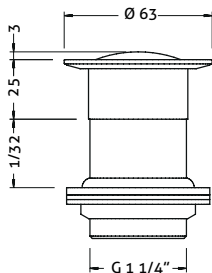

Ref.: 100207 45

Box: 1 | Carton: 60 | Pallet: 1080



9908 0152 | J100206 | 9908 0157 | 9908 0168



9908 0350

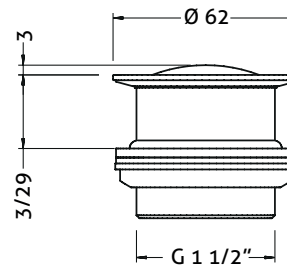

Ref.: 100208 45

Box: 1 | Carton: 80 | Pallet: 2160



9908 0154 | 9908 0156 | 9908 0166

## Accesorios. Accessories

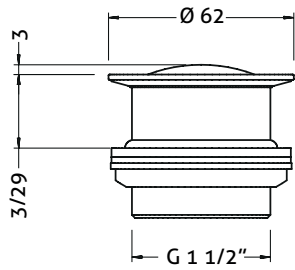

Ref.: 100208 43

Box: 1 | Carton: 80 | Pallet: 2160

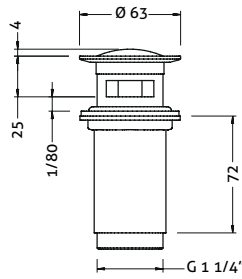

Ref.: 100209 45

Box: 1 | Carton: 60 | Pallet: 1080

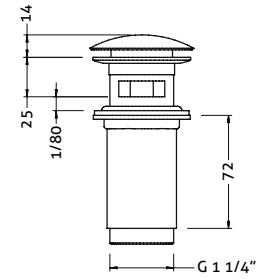

Ref.: 100210 45

Box: 1 | Carton: 60 | Pallet: 1080

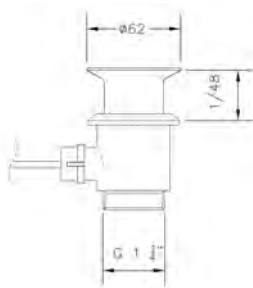

Ref.: 100200 45

| Carton: 100 | Pallet: 1200



Ref.: 100203 45

| Carton: 60 | Pallet: 960

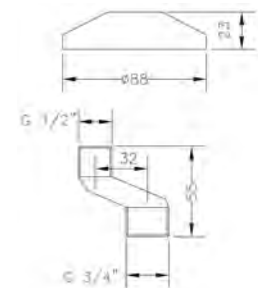

Ref.: 100122 45

Box: 1 | Carton: 72 | Pallet: 1728

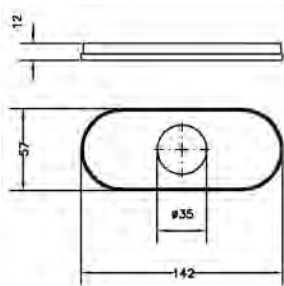

Ref.: P130

Box: 5 | Carton: 240 | Pallet: 4320

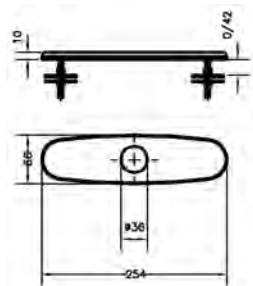

Ref.: P200

Carton: 1

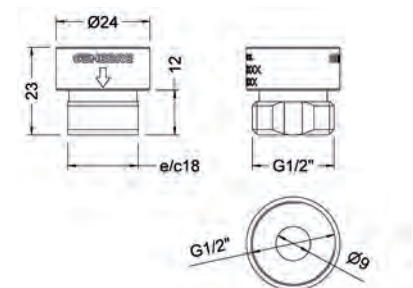

Ref.: 9908 0300 - 9908 0307

Box: 50 | Carton: 500 | Pallet: 14400

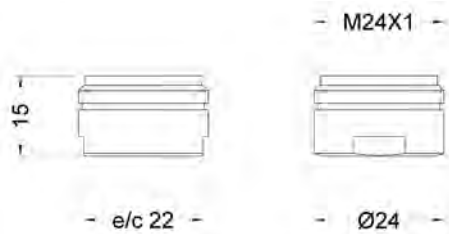

Ref.: 9908 0310 - 9908 0315

Box: 50 | Carton: 500 | Pallet: 18000

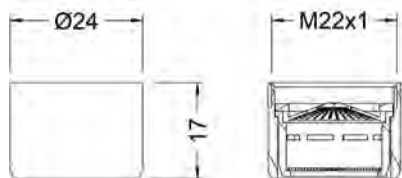

Ref.: 9908 0316 - 9908 0321

Box: 50 | Carton: 500 | Pallet: 18000

# Índice por referencia

## Index by reference

Localiza la referencia en este índice para encontrar la página donde ver el producto o la página para obtener su información técnica.

*Locate the reference in this index to find the page where you can find the product or the page to get its technical information.*



**Información de producto**  
*Product information*



**Información técnica**  
*Technical information*



**Puedes ampliar información en:**  
*You can get more information at:*



[www.genebre.es](http://www.genebre.es)



Página | Page



Product

Technical  
Info

Ref.:	Product	Technical Info
100001 18 45	148, 205	
100001 22 45	148, 205	
100001 28 45	149, 205	
100001 29 45	149, 205	
100001 31 45	149, 205	
100001 32 45	149, 205	
100068 45	58, 189	283
100122 45	200	291
100135 51 00	188	
100135 52 00	188	
100135 60 00	50, 88, 102, 188	283
100137 60 00	58, 60, 188	283
100140 30	188	283
100141 45	188	283
100141 51	188	
100141 52	188	
100149 45	88, 189	283
100152 45 00	189	283
100153 41	189	
100153 45	50, 189	283
100153 51	189	
100153 51	189	
100153 52	189	
100175 45 00	96, 187	282
100197 45 00	50, 187	282
1002 04	103, 105	257
100200 45	197	291
100202 45	197	290
100203 45	197	291
100204 45	197	290
100205 45	197	290
100206 45	197	290
100207 45	197	290
100208 43	111, 197	291
100208 45	197	290
100209 45	197	291
100210 45	197	291
100211 41	197	290
100211 43	197	290
100211 45	197	290
100211 51	197	
100211 52	197	
1003 04	103	257, 280
10041 45	104	

Página | Page



Product

Technical  
Info

Ref.:	Product	Technical Info
1005 04	182	257, 280
1006 04	104	258, 280
100694 41	193	243, 287
100694 45	193	287
100694 51	193	
100694 52	193	
100694 60	193	287
100696 45	104, 193	287
100697 45	188	282
100698 45	188	282
100699 45	188	282
1007 04	104	258, 280
1008 04	182	257, 279
1009 04	182	257, 279
1023 04	103, 182	258, 280
1024 04	103, 182	258, 280
1155 04	192	284
115BOX	202	
116BOX	202	
118BOX	202	
1618 41	189	
1618 51	189	
1618 52	189	
1621 07	198	289
1622 07	198	289
1626 41	198	289
1626 51	198	
1626 52	198	
1632 00	198	
1633 04	189	283
1634 04	189	283
1635 04	189	284
1636 41	190	
1636 45	60, 190	282
1636 51	190	
1636 52	190	
1637 45	190	282
1638 45	102, 190	282
1639 45	190	282
1640 07	198	
1643 45	60, 191	284
1648 41	198	
1648 51	198	
1648 52	198	

Página | Page



Product

Technical  
Info

Ref.:	Product	Technical Info
1649 04	189	284
1650 41	198	
1650 51	198	
1650 52	198	
1667 45	102, 195	287
1668 41	195	288
1668 45	60, 195	288
1668 51	195	
1668 52	195	
1671 41	191	
1671 45	191	285
1671 51	191	
1671 52	191	
1672 45	191	285
1674 41	195	
1674 45	195	288
1674 51	195	
1674 52	195	
1679 04	189	284
1680 04	60, 102, 189	284
1698 45 00	102, 192	284
1744 41	51	244
1744 45	51	241
1745 45	67, 73, 76, 83, 144	249, 251
1746 45	91	254
1747 45	190	282
1748 45	190	282
1946 41	189	283
1946 51	189	
1946 52	189	
3104 04	193	285
3104 05	193	285
3106 04	193	285
3106 05	193	286
3109 04	193	286
3109 05	193	286
3110 03 41	193	285
3110 03 51	193	
3110 03 52	193	
3110 04 41	193	285
3110 04 51	193	
3110 04 52	193	
3113 05 41	193	
3113 05 51	193	

Página | Page



Product

Technical  
Info

Ref.:	Product	Technical Info
3113 05 52	193	
568083 45	181	279
568104 45	181	278
568193 45	181	278
568195 45	181	278
568550 45	178	277
568555 45	178	277
568565 45	178	277
568575 45	178	277
60001 22 45 67	104	258
60100 22 45 66	101	257
60100 28 45 66	96, 97	255
60110 22 45 66	101	257
60110 28 45 66	96	256
60130 22 45 66	100	256
60130 28 45 66	94	254
60134 28 45 66	94	255
60136 28 45 66	94	255
60140 22 45 66	100	256
60140 28 45 66	95	255
60150 28 45 66	94	254
60154 28 45 66	94	255
60170 41 41 66	193	
60170 41 45 66	193	287
60170 41 51 66	193	
60170 41 52 66	193	
60171 41 41 66	194	287
60171 41 45 66	194	
60171 41 51 66	194	
60171 41 52 66	194	
60188 22 45 66	100	256
60188 28 45 66	95	255
60194 05 45 66	167	274
60198 05 45 66	157	271
60199 05 45 66	157	271
61115 22 45 66	101	257
61115 28 45 66	96	256
61116 22 45 66	101, 102	257
61116 28 45 66	96	256
61130 22 45 66	100	256
61130 28 45 66	94	255
61142 22 45 66	100	256
61142 28 45 66	95	255
61150 28 45 66	94	254

Página | Page



Product

Technical  
Info

Ref.:	Product	Technical Info
61190 28 45 66	167	273
61192 28 45 66	167	274
61195 28 45 66	166	274
61196 28 45 66	166	274
61200 28 45 66	153	269
61201 28 45 66	153	269
61203 28 45 66	153	269
61204 28 45 66	153	269
61205 28 45 66	162	272
61206 28 45 66	162	272
61210 28 45 66	153	269
61900 28 45 66	168	274
62100 08 45 67	58	238
62110 31 45 67	58	238
62114 30 45 66	59	239
62115 31 45 66	59	239
62117 31 45 66	59	239
62118 31 45 66	59	239
62119 31 45 66	58	238
62130 08 45 66	56	238
62131 31 45 66	57	238
62132 31 45 66	57	238
62136 08 45 66	56	238
62140 08 45 66	57	238
62142 31 45 66	57	238
63100 26 45 67	88	253
63110 26 45 67	88	253
63114 30 45 66	127, 131, 135	264, 266, 267
63115 26 45 66	89	253
63116 26 45 66	89	253
63119 26 45 66	89	253
63130 26 45 66	86	252
63131 26 45 66	88	252
63132 26 45 66	88	252
63134 26 45 66	86	252
63136 26 45 66	86	252
63137 26 45 66		252
63138 26 45 66	86, 87	252
63140 26 45 66	88	252
63142 26 45 66	88	252
64100 16 45 66	65	245
64100 32 41 66	37	236
64100 32 45 66	37	234
64110 16 45 66	65	246

Página | Page



Product

Technical  
Info

Ref.:	Product	Technical Info
64110 32 41 66	37	236
64110 32 45 66	37	234
64111 14 45 67	75	249
64114 14 45 67	75	249
64114 30 41 66	39	237
64114 30 45 66	39	235
64115 16 45 66	66, 144	246
64115 32 41 66	39	237
64115 32 45 66	39	234
64116 16 45 66	66, 67, 144	246
64116 32 41 66	39	237
64116 32 45 66	39	235
64117 04 45 66	66	246
64117 32 41 66	39	237
64117 32 45 66	39	235
64118 04 45 66	66	246
64118 32 41 66	39	237
64118 32 45 66	39	235
64119 32 41 66	38	237
64119 32 45 66	38	234
64130 16 45 66	64	245
64130 32 41 66	34, 35	236
64130 32 45 66	34	233
64131 16 45 66	65	245
64131 32 41 66	37	236
64131 32 45 66	37	234
64132 16 45 66	65	245
64132 32 41 66	36, 37	236
64132 32 45 66	37	234
64134 16 45 66	64	245
64134 32 41 66	34	236
64134 32 45 66	34	233
64136 16 45 66	64	245
64136 32 41 66	34	236
64136 32 45 66	34	234
64140 16 45 66	65	245
64140 32 41 66	37	236
64140 32 45 66	37	234
64142 16 45 66	65	245
64142 32 41 66	37	236
64142 32 45 66	37	234
64150 16 45 66	64	245
64150 32 45 66	34	233
64192 16 45 66	166	273

Página | Page



Product

Technical  
Info

Ref.:	Product	Technical Info
64192 32 45 66	166	273
64201 04 45 66	152	268
64201 16 45 66	152	268
64201 32 45 66	152	268
64206 16 45 66	162	272
64206 32 45 66	162	272
64316 32 41 66	39	237
64316 32 45 66	39	235
65100 18 45 66	72	247
65100 19 41 66	50	243
65100 19 45 66	50	240
65100 29 45 66	81	250
65110 18 45 66	72	247
65110 19 41 66	50	243
65110 19 45 66	50	241
65110 29 45 66	81	250
65114 30 45 66	66, 74, 138	246, 247
65115 18 45 66	74, 138	247
65115 19 41 66	50	244
65115 19 45 66	50	241
65115 29 45 66	82	251
65116 18 45 66	74	247
65116 19 41 66	50	244
65116 19 45 66	50	241
65116 29 45 66	82	251
65117 18 45 66	74	247
65118 18 45 66	74, 140	247
65119 18 45 66	72	247
65119 29 45 66	82	250
65120 45	109, 194	259
65130 19 41 66	44	242
65130 19 45 66	44	239
65131 18 45 66	71	247
65131 19 41 66	48	243
65131 19 45 66	48	240
65131 29 45 66	80	250
65132 18 45 66	71	247
65132 19 41 66	48	243
65132 19 45 66	48	240
65132 29 45 66	80	250
65134 18 45 66	70	247
65134 19 41 66	44	242
65134 19 45 66	44	239
65134 29 45 66	80	250

Página | Page



Product

Technical  
Info

Ref.:	Product	Technical Info
65135 18 45 66	70	247
65135 29 45 66	80	250
65136 18 45 66	70	247
65136 19 41 66	44, 45	242
65136 19 45 66	44	240
65136 29 45 66	80	250
65138 18 45 66	71	247
65139 19 41 66	46, 47	243
65139 19 45 66	47	240
65140 19 41 66	49	243
65140 19 45 66	49	240
65142 18 45 66	71	247
65142 19 41 66	49	243
65142 19 45 66	49	240
65142 29 45 66	81	250
65144 19 41 66	49	243
65144 19 41 67	49, 194	243
65144 19 45 66	49, 194	240
65144 19 45 67	49, 194	240
65144 19 51 67	194	
65144 19 52 67	194	
65145 18 45 66	71	247
65145 29 45 66	81	250
65150 19 45 66	44	239
65192 18 45 66	166	273
65192 19 45 66	167	273
65200 19 45 66	154	269
65203 18 45 66	152	269
65203 18 60 66	169	274
65203 19 45 66	154	270
65204 18 45 66	152	269
65205 18 45 66	162	271
65206 18 45 66	162	271
65207 18 60 66	165, 169	274
65211 18 45 66	165	272
65211 18 60 66	165, 169	274
65212 18 45 66	164, 165	273
65214 18 45 66	152	269
65215 18 45 66	155	270
65215 40 60 66	170, 171	275
65219 18 45 66	157	270
65219 40 60 66	169, 170	275
65403 18 40 66	155	
65403 18 41 66	155	

Página | Page



Product

Technical  
Info

Ref.:	Product	Technical Info
65403 18 44 66	155	
65403 18 45 66	155	270
65404 18 45 66	154	270
65700 18 45 66	159	271
65702 18 41 66	159	
65702 18 44 66	159	
65702 18 45 66	159	271
65900 18 45 66	168	274
67100 26 45 67		253
67102 14 45 67	75	247
67103 14 45 67	66, 67	246
67104 14 45 67	66	246
67110 26 45 67	89	253
67112 14 45 67	75	247
68001 09 45 66	116	261
68001 11 45 66	122	263
68003 11 45 66	176	276
68083 11 45 66	180	278
68093 11 45 66	180	278
68100 11 45 66	120	262
68103 11 45 66	179	278
68104 11 45 66	179	278
68110 11 45 66	120	262
68113 07 45 66	135	264
68113 08 45 66	131	266
68113 12 45 66	127	267
68115 07 45 66	135	264
68115 08 45 66	131	266
68115 11 45 66	122	263
68115 12 45 66	127	267
68116 07 45 66	135	264
68116 08 45 66	131	266
68116 11 45 66	122	263
68116 12 45 66	127	267
68120 07 45 66	134	264
68120 08 45 66	130	265
68120 09 45 66	114, 117	260
68120 11 45 66	120	262
68120 12 45 66	126	267
68122 11 45 66	120	262
68124 07 45 66	134	264
68124 08 45 66	130	265
68124 12 45 66	126	267
68125 07 45 66	134	264



Página | Page



Ref.:	Product	Technical Info
68125 08 45 66	130	265
68125 12 45 66	126	267
68130 11 45 66	120	262
68131 07 45 66	134	264
68131 08 45 66	131	266
68131 09 45 66	116	261
68131 11 45 66	122	263
68131 12 45 66	127	267
68132 07 45 66	134	264
68132 08 45 66	131	266
68132 12 45 66	127	267
68140 11 45 66	120	262
68142 07 45 66	135	265
68142 08 45 66	131	266
68142 09 45 66	115	260
68142 11 45 66	120	262
68142 12 45 66	127	268
68160 11 45 66	120	262
68170 07 45 66	135	265
68170 08 45 66	131	266
68170 11 45 66	122	263
68170 12 45 66	127	268
68180 11 45 66	120	262
68190 11 45 66	180	278
68193 11 45 66	179	277
68194 09 45 66	174	276
68194 11 45 66	175	275
68195 11 45 66	179	278
68196 09 45 66	176	276
68196 11 45 66	179	277
68197 11 45 66	179	277
68199 11 45 66	175	276
68200 11 45 66	175	275
68201 39 43 66	172	275
68201 39 45 66	172, 173	
68500 09 45 66	115	260
68505 09 45 66	114	260
68506 09 43 66	110	259
68506 09 45 66	108	258
68510 09 45 66	114	260
68511 09 45 66	115	260
68515 09 45 66	115	260
68516 09 43 66	110	259
68516 09 45 66	108	258

Página | Page



Ref.:	Product	Technical Info
68520 09 45 66	115	260
68525 09 45 66	115	260
68526 09 43 66	110	259
68526 09 45 66	108, 109	259
68527 09 45 66	116	261
68530 09 45 66	115	261
68531 09 43 66	110	259
68531 09 45 66	108	259
68535 09 45 66	116	261
68540 09 45 66	174	275
68545 09 45 66	174	275
68550 09 45 66	176	276
68555 09 45 66	176	276
68560 09 45 66	176	276
68565 09 45 66	176	276
68570 09 45 66	176	276
68575 09 45 66	177	277
68580 09 45 66	177	277
68585 09 45 66	174	275
68590 09 45 66	116	261
68595 09 43 66	172	
68595 09 45 66	172	275
68901 45	178, 181	279
68902 45	178, 181	279
68904 45	178, 181	279
68908 45	178, 181	279
68909 45	178, 181	279
68910 45	178, 181	279
68911 45	195	288
68912 45	195	288
68913 45	195	288
68914 45	195	288
68915 45	195	288
68916 45	195	288
68917 45	195	289
69100 34 41 66	31	232
69100 34 45 66	31	232
69100 34 51 66	31	232
69100 34 52 66	31	232
69110 34 41 66	31	231
69110 34 45 66	31	231
69110 34 51 66	31	232
69110 34 52 66	31	232
69115 34 41 66	31	232

Página | Page



Ref.:	Product	Technical Info
69115 34 45 66	31	232
69115 34 51 66	31	232
69115 34 52 66	31	232
69116 34 41 66	31	233
69116 34 45 66	31	233
69116 34 51 66	31	233
69116 34 52 66	31	233
69130 34 41 66	27	229
69130 34 45 66	27	229
69130 34 51 66	27	229
69130 34 52 66	27	230
69131 34 41 66	28	230
69131 34 45 66	28	230
69131 34 51 66	28	230
69131 34 52 66	28	230
69132 34 41 66	28	230
69132 34 45 66	28	230
69132 34 51 66	28	230
69132 34 52 66	28, 29	230
69134 34 41 66	27	229
69134 34 45 66	27	229
69134 34 51 66	27	229
69134 34 52 66	27	230
69136 34 41 66	27	229
69136 34 45 66	27	229
69136 34 51 66	27	229
69136 34 52 66	26, 27	230
69140 34 41 66	28	230
69140 34 45 66	28	230
69140 34 51 66	28	231
69140 34 52 66	28	231
69142 34 41 66	28	
69142 34 45 66	28	
69142 34 51 66	28	
69142 34 52 66	28	
9908 0285	188	
9908 0287	188	283
9908 0300	199	291
9908 0301	199	291
9908 0302	199	291
9908 0303	199	291
9908 0304	199	291
9908 0305	199	291
9908 0306	199	291

Página | Page



Product

Technical  
Info

Ref.:	Product	Technical Info
9908 0307	199	291
9908 0310	199	291
9908 0311	199	291
9908 0312	199	291
9908 0313	199	291
9908 0314	199	291
9908 0315	199	291
9908 0316	199	291
9908 0317	199	291
9908 0318	199	291
9908 0319	199	291
9908 0320	199	291
9908 0321	199	291
B115 40 10	148, 204	
B117 40 10	149, 204	
B118 40 10	149, 204	
B63113 26	191	285
B64113 41	191	285
B64113 43	191	285
B64113 51	191	285
B64113 52	191	
B65113 18	60, 102, 191	285
B65114 18	191	285
CM63110 26	91	254
CM64110 32	40, 41	235
CM64111 32 41	40	237
CM65110 18	76, 77	249
CM65110 19	51	241
CM65110 29	83	251
CM65111 19 41	51	244
CT67110 18	76, 83	249, 251
CT67110 19	51	242
CT67110 26	90, 91	254
CT67111 19 41	51	244
DXE2 45	102, 187	281
DXE5 45	187	281
DXK1 45	186	282
DXK3 45	88, 186	281
DXL3 41	186	
DXL3 41	186	
DXL3 41	186	
DXL3 45	186	
DXL3 45	186	
DXL3 51	186	

Página | Page



Product

Technical  
Info

Ref.:	Product	Technical Info
DXL3 51	186	
DXL3 52	186	
DXL3 52	186	
DXO3 45	58, 60	281
DXO3 45	186	281
DXT3 45	186	281
DXT5 45	186	281
EXT0001	202	
EXT0002	202	
EXT0003	202	
EXT0004	202	
EXT0005	202	
EXT0006	202	
FRK63400	156, 157	270
FRK63401	157	270
FRT65401	155	270
FRT65402	154	270
FRV61205	162	272
FRV61206	161	271
FRV61207 40	161	
FRV61207 41	161	
FRV61207 44	161	271
FRV61208 41	161	
FRV61208 44	160, 161	271
FRV61208 45	161	
FT00	158, 159, 200	281
FT01	158, 159, 200	281
FT91	158, 200	
FT92	158, 200	
KPB115 40 45	148, 204	
KPB117 40 45	149, 204	
KPB118 40 45	149, 204	
KPC115 40 41	148, 205	
KPC115 40 45	148, 204	
KPC117 40 41	149, 205	
KPC117 40 45	149, 204	
KPC118 40 41	149, 205	
KPC118 40 45	149, 204	
KPT115 40 45	148, 204	
KPT117 40 45	149, 204	
KPT118 40 45	149, 204	
P130	200	291
P200	200	291
R63112 08	60, 192	284

Página | Page



Product

Technical  
Info

Ref.:	Product	Technical Info
R63112 26	192	284
R65110 41	192	
R65110 51	192	
R65110 52	192	
R65110 60	192	
R65112 18	102, 191	284
R65112 41	191	284
R65130 41	192	
R65130 51	192	
R65130 52	192	
R65130 60	192	
R65150 60	192	
R65170 60	192	
R68113 43	111, 191	284
ST1111941	52, 53	
ST116 19	52	241

# Condiciones Generales de Venta

General Sales Conditions



**Ver Tarifa de Precios Grifería 2024**  
*See Taps Collection 2024 Price List*





**PRECIOS:** Los precios se entienden en nuestro almacén, siendo los portes, el I.V.A. y acarreo a cargo del comprador, salvo acuerdo previo en contra.

**CONDICIONES DE PAGO:** En aplicación de la Ley 15/2010 que limita los plazos máximos de pago en las operaciones comerciales, hemos ajustado las condiciones a lo dispuesto en la misma. En caso de diferirse el pago, los gastos de negociación de efectos y/o los intereses legales especificados serán a cargo del comprador. El impago de cualquier efecto o recibo, conllevará la inmediata suspensión de suministros y servicios.

**PEDIDOS:** Para la tramitación de cualquier suministro será indispensable que el comprador nos remita el pedido por escrito indicando claramente la referencia Genebre, incluidos los dígitos de la medida y también la cantidad deseada respetando las unidades de compra mínima (por caja), tal como especifica Genebre en su catálogo. El importe mínimo del pedido se establece en 50€ para pedidos del Mercado Nacional y de 100€ para pedidos comunitarios. Si existen condicionantes no previstos, Genebre S.A. se reserva el derecho de aceptación o anulación de los pedidos cursados. Cada pedido solicitado a Genebre S.A. genera una expedición para el cliente con su coste de transporte correspondiente; por lo que recomendamos preparen sus pedidos completos una vez al día para optimizar el transporte. Todos los pedidos serán confirmados por Genebre, S.A. vía email/fax. Salvo notificación de lo contrario en las siguientes 2 horas (Mercado Nacional), el pedido confirmado seguirá su curso sin derecho a posteriores reclamaciones.

**TARIFAS DE PRECIOS:** Genebre S.A. comunicará a sus clientes cualquier cambio que se produzca en las tarifas del catálogo a través de alguna de las vías de comunicación usuales (web, email, correo).

**CANCELACIÓN DE PRODUCTOS DE CATÁLOGO:**

Genebre, S.A. comunicará a sus clientes cualquier cancelación de productos del catálogo.

**ESPECIFICACIONES TÉCNICAS:** El catálogo de Genebre, S.A. contiene los requisitos técnicos y normas aplicables a los productos suministrados. Genebre S.A. se reserva la facultad de cambiar en todo o en parte el diseño y materiales de cualquiera de sus productos, debido a la mejora continua de nuestros productos.

**EXPEDICIONES:** Todo pedido superior a 500 euros en Península se suministran a portes pagados. Para Canarias, Ceuta, Melilla y Andorra, el pedido mínimo será de 1.000 euros. Las mercancías viajan siempre por cuenta y riesgo del comprador, aún en los casos de convenios especiales.

**ENTREGA:** Los pedidos se suministrarán siempre por cajas completas, según especificaciones de catálogo.

**RECLAMACIONES:** Las eventuales reclamaciones deberán formularse dentro de los 15 días siguientes al de recepción de la mercancía por el comprador, rechazándose las efectuadas después de dicho plazo límite. NO se aceptará ninguna devolución de material sin aprobación previa de nuestro Departamento Comercial que facilitará un número de boletín de devolución que debe acompañar al material devuelto. Todas las devoluciones serán con los portes a cargo del comprador. Y se realizará un cargo por demérito del 10% del valor de la mercancía para todos los materiales, excepto para las válvulas automatizadas que será del 30%.

**GARANTÍA:** Queda limitada al reemplazo de las piezas reconocidas como defectuosas de fabricación por el Departamento de Calidad de Genebre S.A.. No admitiremos ninguna reclamación transcurridos 15 días de la recepción de la mercancía por el comprador.

**PROPIEDAD DE LA MERCANCÍA:** Genebre, S.A. se reserva el derecho de propiedad de la mercancía suministrada, hasta que el comprador no haya satisfecho totalmente el importe de la misma. En el intervalo, se considerará en concepto de depósito y custodia. La mercancía podrá ser retirada por incumplimiento de pago en el plazo previamente estipulado.

**LITIGIOS:** En caso de litigio, ambas partes aceptan someter sus diferencias a los Juzgados de L'Hospitalet de Llobregat.

**PRICES:** Prices are considered to be EX WORKS, being the freight and transportation at the cost of the purchaser, unless previous agreement has been reached.

**PAYMENT TERMS:** We have adjusted the conditions in application of Law 15/2010 which limits the maximum terms of payment in commercial transactions. The maximum delay on payment will be of 60 days after invoice date. Payment term will be as accorded between the parties. In case of unpaid, the expenses and interest occurred will be paid by the purchaser. The unpaid maturity will imply the complete suspension of any service or supply.

**ORDERS:** Regarding the handling of any supply, it is compulsory for the purchaser to send a written signed and sealed purchasing order indicating clearly Genebre's reference, including measures digits, and also the quantity required subject to obligated minimum units of purchase (boxes), as Genebre's Catalogue specifies. The minimum order amount is set at €50 for National Market orders and 100€ for community orders. In case of unexpected discrepancies, Genebre has the right to accept or cancel the pending orders. Each order required to Genebre, S.A., opens a client expedition with corresponding transports cost, because of that, we recommend to prepare complete orders once a day to improve the transport. All the orders will be confirmed by Genebre by e-mail/fax. Each confirmed order will handled without any right from the purchaser to modify it, unless previous notification before 2 hours (National Market) after confirmation.

**PRICE LIST:** Genebre will inform the customers about any change in the price list, using some usual communication way (web, e-mail or post).

**PRODUCTS WITHDRAWAL FROM CATALOGUE:**

Genebre S.A. will inform the customers about any product withdrawal from the catalogue.

**TECHNICAL SPECIFICATIONS:** Genebres's catalogue holds all the technical requirements and applicable norms about the products.

**SHIPMENT:** Goods are shipped under the purchaser's own risk, even in special cases.

**DELIVERY:** Orders will always be shipped according to full boxes, as specified in the catalogue.

**CLAIMS:** Eventual claims must be done within 15 days after date of reception of the goods by the purchaser. Claims after such period will not be considered. NO devolution will be accepted without the previous approval from our Sales Department, who will issue a devolution certificate that must be enclosed in the devolution goods. All devolutions' freight will be paid by the purchaser. Additionally, an unworthiness debit of 10% of the products' value will be charged, except for the automatic valves that are a 30%.

**GUARANTEE:** It is limited to defective pieces replacement identified by Genebre's Quality Department. We will not accept any return after 15 days from the date of reception by the purchaser.

**PROPERTY OF THE GOODS:** Genebre has the property right of the supplied goods, until the purchaser has totally paid its value. In the meantime, it will be considered as deposit and custody. Goods shall be claimed in case of breach of payment terms.

**DISPUTES:** In case of disputes, both parties agree to solve discrepancies in the Barcelona Court of Justice.

**GENEBRE**

W A T E R   C A R E   V I S I O N E E R S

[www.genebre.es](http://www.genebre.es)





# GENEBRE

WATER CARE VISIONEERS

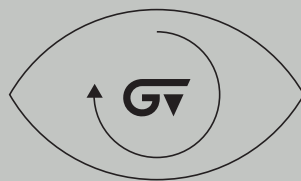

[www.genebre.es](http://www.genebre.es)